

PROJECT PRICE LIST

EFFECTIVE OCT 2021



MINIATURE
CIRCUIT BREAKER



MOULDED CASE
CIRCUIT BREAKER



DISTRIBUTION
BOARD



ONLOAD
CHANGEOVER



HRC FUSES



WIRING
DEVICES

Contents

—optipro—	MINIATURE CIRCUIT BREAKER (MCBs)	01 - 04
—optipro—	AC CIRCUIT BREAKER	05
—optipro—	DC CIRCUIT BREAKER	05 - 06
—optipro—	DC MCB WITH EXTENDED LINK AS PER RDSO	06
—optipro—	ISOLATOR	07
—optipro—	RESIDUAL CURRENT CIRCUIT BREAKER (RCCBs)	07
—optipro—	RCD ADD ON BLOCK	08
—optipro—	ACCESSORIES	08
—optipro—	DISTRIBUTION BOARDS (DBs)	10 - 16
	BUSBAR CHAMBER	17
	TIME SWITCHES	18
	TIMELITE DISTRIBUTION BOARDS	19
—optium—	1.0 (FIXED TM RANGE)	21 - 23
—optium—	2.0 (ADJUSTABLE TM RANGE)	23 - 25
—optium—	2.1 (ELECTRONIC / MICRO -PROCESSOR RANGE)	25
—optium—	OPTIUM 2.2 (WITH ELECTRONIC / MICRO PROCESSOR RELEASE)	25
—optium—	2.2 (ELECTRONIC / MICRO -PROCESSOR RANGE)	26
—optium—	ACCESSORIES	26 - 28
	LOAD BANK	30
	HRC FUSE LINKS & BASES	32
	SWITCH DISCONNECTOR FUSES	33
	Ambidex CHANGEOVER SWITCHES	34
	REWIRABLE SWITCH FUSE UNITS	35
	Glint [™] WIRING ACCESSORIES	37 - 39
	ELVIRA WIRING ACCESSORIES	42 - 46
	INDOASIAN PLUGS	46

—optipro— **MINIATURE CIRCUIT BREAKER - MCB**

- ISI / CE Marked as per IS/IEC 60898 - 1 • Rated Short-Circuit Breaking Capacity, Icn 10kA • Degree of Protection IP 20
- Energy Limitation Class 3 • Line Load Reversibility • 35 sq. mm Terminals • Biconnect Terminals • Frequency: 50 Hz
- Operating Voltage : 240V / 415V AC , 60V DC per pole

B CURVE SINGLE POLE

HSN Code: 8536

	Rating (A)	Pack	Cat. Nos.	Unit Price (₹)
	6	1/12/180	811008	242
10	1/12/180	811010	242	
16	1/12/180	811012	242	
20	1/12/180	811013	242	
25	1/12/180	811014	242	
32	1/12/180	811015	242	
40	1/12/180	811016	550	
50	1/12/180	811017	640	
63	1/12/180	811018	640	

B CURVE SINGLE POLE NEUTRAL

HSN Code: 8536

	Rating (A)	Pack	Cat. Nos.	Unit Price (₹)
	6	1/6/90	811027	788
10	1/6/90	811029	788	
16	1/6/90	811031	788	
20	1/6/90	811032	788	
25	1/6/90	811033	788	
32	1/6/90	811034	788	
40	1/6/90	811035	1086	
50	1/6/90	811036	1242	
63	1/6/90	811037	1242	

B CURVE DOUBLE POLE

HSN Code: 8536

	Rating (A)	Pack	Cat. Nos.	Unit Price (₹)
	6	1/6/90	811046	820
10	1/6/90	811048	820	
16	1/6/90	811050	820	
20	1/6/90	811051	820	
25	1/6/90	811052	820	
32	1/6/90	811053	820	
40	1/6/90	811054	1182	
50	1/6/90	811055	1316	
63	1/6/90	811056	1316	

C CURVE SINGLE POLE

HSN Code: 8536

	Rating (A)	Pack	Cat. Nos.	Unit Price (₹)
	0.5	1/12/180	811114	420
1	1/12/180	811115	420	
2	1/12/180	811117	420	
3	1/12/180	811119	420	
4	1/12/180	811120	420	
5	1/12/180	811121	420	
6	1/12/180	811122	256	
10	1/12/180	811124	256	
16	1/12/180	811126	256	
20	1/12/180	811127	256	
25	1/12/180	811128	256	
32	1/12/180	811129	256	
40	1/12/180	811130	592	
50	1/12/180	811131	610	
63	1/12/180	811132	610	

—optipro— **MINIATURE CIRCUIT BREAKER - MCB**

C CURVE SINGLE POLE NEUTRAL

HSN Code: 8536

	Rating (A)	Pack	Cat. Nos.	Unit Price (₹)
		0.5	1/6/90	811136
	1	1/6/90	811137	1158
	2	1/6/90	811139	1158
	3	1/6/90	811141	1158
	4	1/6/90	811142	1158
	5	1/6/90	811143	1158
	6	1/6/90	811144	806
	10	1/6/90	811146	806
	16	1/6/90	811148	806
	20	1/6/90	811149	806
	25	1/6/90	811150	806
	32	1/6/90	811151	806
	40	1/6/90	811152	1182
	50	1/6/90	811153	1332
	63	1/6/90	811154	1332

C CURVE DOUBLE POLE

HSN Code: 8536

	Rating (A)	Pack	Cat. Nos.	Unit Price (₹)
		0.5	1/6/90	811158
	1	1/6/90	811159	1180
	2	1/6/90	811161	1180
	3	1/6/90	811163	1180
	4	1/6/90	811164	1180
	5	1/6/90	811165	1180
	6	1/6/90	811166	828
	10	1/6/90	811168	828
	16	1/6/90	811170	828
	20	1/6/90	811171	828
	25	1/6/90	811172	828
	32	1/6/90	811173	828
	40	1/6/90	811174	1260
	50	1/6/90	811175	1348
	63	1/6/90	811176	1348

6

C CURVE THREE POLE

HSN Code: 8536

	Rating (A)	Pack	Cat. Nos.	Unit Price (₹)
		0.5	1/4/60	811180
	1	1/4/60	811181	1630
	2	1/4/60	811183	1630
	3	1/4/60	811185	1630
	4	1/4/60	811186	1630
	5	1/4/60	811187	1630
	6	1/4/60	811188	1318
	10	1/4/60	811190	1318
	16	1/4/60	811192	1318
	20	1/4/60	811193	1318
	25	1/4/60	811194	1318
	32	1/4/60	811195	1318
	40	1/4/60	811196	1930
	50	1/4/60	811197	2038
	63	1/4/60	811198	2038

—optipro— **MINIATURE CIRCUIT BREAKER - MCB**

C CURVE THREE POLE NEUTRAL

HSN Code: 8536



Rating (A)	Pack	Cat. Nos.	Unit Price (₹)
0.5	1/3/45	811202	2092
1	1/3/45	811203	2092
2	1/3/45	811205	2092
3	1/3/45	811207	2092
4	1/3/45	811208	2092
5	1/3/45	811209	2092
6	1/3/45	811210	1726
10	1/3/45	811212	1726
16	1/3/45	811214	1726
20	1/3/45	811215	1726
25	1/3/45	811216	1726
32	1/3/45	811217	1726
40	1/3/45	811218	2218
50	1/3/45	811219	2326
63	1/3/45	811220	2326

C CURVE FOUR POLE

HSN Code: 8536



Rating (A)	Pack	Cat. Nos.	Unit Price (₹)
0.5	1/3/45	811224	2122
1	1/3/45	811225	2122
2	1/3/45	811227	2122
3	1/3/45	811229	2122
4	1/3/45	811230	2122
5	1/3/45	811231	2122
6	1/3/45	811232	1778
10	1/3/45	811234	1778
16	1/3/45	811236	1778
20	1/3/45	811237	1778
25	1/3/45	811238	1778
32	1/3/45	811239	1778
40	1/3/45	811240	2528
50	1/3/45	811241	2560
63	1/3/45	811242	2560

D CURVE SINGLE POLE

HSN Code: 8536



Rating (A)	Pack	Cat. Nos.	Unit Price (₹)
0.5	1/12/180	811246	452
1	1/12/180	811247	452
2	1/12/180	811249	452
3	1/12/180	811251	452
4	1/12/180	811252	452
5	1/12/180	811253	452
6	1/12/180	811254	378
10	1/12/180	811256	378
16	1/12/180	811258	378
20	1/12/180	811259	378
25	1/12/180	811260	378
32	1/12/180	811261	378
40	1/12/180	811262	638
50	1/12/180	811263	728
63	1/12/180	811264	728

—optipro— **MINIATURE CIRCUIT BREAKER - MCB**

D CURVE DOUBLE POLE

HSN Code: 8536

	Rating (A)	Pack	Cat. Nos.	Unit Price (₹)
	0.5	1/6/90	811284	1198
1	1/6/90	811285	1198	
2	1/6/90	811287	1198	
3	1/6/90	811289	1198	
4	1/6/90	811290	1198	
5	1/6/90	811291	1198	
6	1/6/90	811292	932	
10	1/6/90	811294	932	
16	1/6/90	811296	932	
20	1/6/90	811297	932	
25	1/6/90	811298	932	
32	1/6/90	811299	932	
40	1/6/90	811300	1336	
50	1/6/90	811301	1422	
63	1/6/90	811302	1422	

D CURVE THREE POLE

HSN Code: 8536

	Rating (A)	Pack	Cat. Nos.	Unit Price (₹)
	0.5	1/4/60	811303	1722
1	1/4/60	811304	1722	
2	1/4/60	811306	1722	
3	1/4/60	811308	1722	
4	1/4/60	811309	1722	
5	1/4/60	811310	1722	
6	1/4/60	811311	1390	
10	1/4/60	811313	1390	
16	1/4/60	811315	1390	
20	1/4/60	811316	1390	
25	1/4/60	811317	1390	
32	1/4/60	811318	1390	
40	1/4/60	811319	2098	
50	1/4/60	811320	2168	
63	1/4/60	811321	2168	

D CURVE FOUR POLE

HSN Code: 8536

	Rating (A)	Pack	Cat. Nos.	Unit Price (₹)
	0.5	1/3/45	811341	2150
1	1/3/45	811342	2150	
2	1/3/45	811344	2150	
3	1/3/45	811346	2150	
4	1/3/45	811347	2150	
5	1/3/45	811348	2150	
6	1/3/45	811349	1832	
10	1/3/45	811351	1832	
16	1/3/45	811353	1832	
20	1/3/45	811354	1832	
25	1/3/45	811355	1832	
32	1/3/45	811356	1832	
40	1/3/45	811357	2596	
50	1/3/45	811358	2744	
63	1/3/45	811359	2744	

—optipro— **AC CIRCUIT BREAKER**

- Conforms to IEC 60947 - 2 • CE Marked • Rated Short-Circuit Capacity, Icu 10kA • Degree of Protection IP 20
- 1.5 Module per pole • 50 sq. mm Terminals • Frequency: 50 Hz • Operating Voltage: 240V/415V AC, 60V DC per Pole

SINGLE POLE

HSN Code: 8536

	Rating (A)	Pack	Cat. Nos.	Unit Price (₹)
	80	1	811133	2294
	100	1	811134	2542
	125	1	811135	2834

DOUBLE POLE

HSN Code: 8536

	Rating (A)	Pack	Cat. Nos.	Unit Price (₹)
	80	1	811177	5280
	100	1	811178	5680
	125	1	811179	6224

THREE POLE

HSN Code: 8536

	Rating (A)	Pack	Cat. Nos.	Unit Price (₹)
	80	1	811199	7772
	100	1	811200	8376
	125	1	811201	9100

FOUR POLE

HSN Code: 8536

	Rating (A)	Pack	Cat. Nos.	Unit Price (₹)
	80	1	811243	10158
	100	1	811244	10490
	125	1	811245	11926

—optipro— **DC CIRCUIT BREAKER**

- Conforms to IEC 60947 - 2 • CE Marked • Breaking Capacity 6kA • Degree of Protection IP 20 • 35 sq. mm Terminals
- Biconnect Terminals • Upto 250V Supply

SINGLE POLE

HSN Code: 8536

	Rating (A)	Pack	Cat. Nos.	Unit Price (₹)
	0.5	1/12/180	811400	566
	1	1/12/180	811401	566
	2	1/12/180	811403	566
	3	1/12/180	811405	566
	4	1/12/180	811406	566
	5	1/12/180	811407	566
	6	1/12/180	811408	506
	10	1/12/180	811410	506
	16	1/12/180	811412	506
	20	1/12/180	811413	506
	25	1/12/180	811414	506
	32	1/12/180	811415	506
	40	1/12/180	811416	672
	50	1/12/180	811417	682
	63	1/12/180	811418	682

—optipro— **DC CIRCUIT BREAKER**

DOUBLE POLE

HSN Code: 8536

	Rating (A)	Pack	Cat. Nos.	Unit Price (₹)
	0.5	1/6/90	811419	1274
	1	1/6/90	811420	1274
	2	1/6/90	811422	1274
	3	1/6/90	811424	1274
	4	1/6/90	811425	1274
	5	1/6/90	811426	1274
	6	1/6/90	811427	1046
	10	1/6/90	811429	1046
	16	1/6/90	811431	1046
	20	1/6/90	811432	1046
	25	1/6/90	811433	1046
	32	1/6/90	811434	1046
	40	1/6/90	811435	1428
	50	1/6/90	811436	1536
	63	1/6/90	811437	1536

OPTIPRO DC MCB WITH EXTENDED LINK AS PER RDSO

HSN Code: 8536

Rating (A)	Pack	Cat. Nos.	Unit Price (₹)
0.5	1/-/48	811451	636
1	1/-/48	811452	636
1.5	1/-/48	811453	636
1.6	1/-/48	811454	636
2	1/-/48	811455	636
2.5	1/-/48	811456	636
3	1/-/48	811457	636
4	1/-/48	811458	636
5	1/-/48	811459	636
6	1/-/48	811460	596
7.5	1/-/48	811461	596
10	1/-/48	811462	596
15	1/-/48	811463	596
16	1/-/48	811464	596
20	1/-/48	811465	596
25	1/-/48	811466	596
30	1/-/48	811467	596
35	1/-/48	811468	788
40	1/-/48	811469	788
50	1/-/48	811470	788
60	1/-/48	811471	788

—optipro— **ISOLATOR**

- Conforms to IEC 60947-3 • CE Marked • Degree of Protection IP 20 • 35 sq. mm Terminals • Biconnect Terminals
- Frequency: 50 Hz • Operating Voltage: 240V/415V AC, 60V DC per Pole

DOUBLE POLE

HSN Code: 8536

	Rating (A)	Pack	Cat. Nos.	Unit Price (₹)
	40	1/6/90	811550	518
	63	1/6/90	811551	640
	80	1/6/90	811552	826
	100	1/6/90	811553	826
	125	1/6/90	811554	890

THREE POLE

HSN Code: 8536

	Rating (A)	Pack	Cat. Nos.	Unit Price (₹)
	40	1/4/60	811555	970
	63	1/4/60	811556	1108
	80	1/4/60	811557	1250
	100	1/4/60	811558	1250
	125	1/4/60	811559	1370

FOUR POLE

HSN Code: 8536

	Rating (A)	Pack	Cat. Nos.	Unit Price (₹)
	40	1/3/45	811560	1158
	63	1/3/45	811561	1250
	80	1/3/45	811562	1552
	100	1/3/45	811563	1552
	125	1/3/45	811564	1678

—optipro— **RESIDUAL CURRENT CIRCUIT BREAKER - RCCB**

- ISI/CE marked as per IS/IEC 12640-1 • Degree of Protection IP 20 • Rated Conditional Short-Circuit Current, ICC10kA
- 35 sq. mm Terminals • Biconnect Terminals • Frequency: 50 Hz • Operating Voltage: 240V/415V AC

DOUBLE POLE

HSN Code: 8536

	Rating (A)	Sensitivity (mA)	Pack	Cat. Nos.	Unit Price (₹)
	25	30	1/6/90	811700	3118
		100	1/6/90	811706	3118
		300	1/6/90	811712	3246
	40	30	1/6/90	811701	3204
		100	1/6/90	811707	3204
		300	1/6/90	811713	3492
	63	30	1/6/90	811702	4284
		100	1/6/90	811708	4284
		300	1/6/90	811714	4376

FOUR POLE

HSN Code: 8536

	Rating (A)	Sensitivity (mA)	Pack	Cat. Nos.	Unit Price (₹)
	25	30	1/3/45	811718	4000
		100	1/3/45	811724	4000
		300	1/3/45	811730	4154
	40	30	1/3/45	811719	4102
		100	1/3/45	811725	4102
		300	1/3/45	811731	4330
	63	30	1/3/45	811720	4440
		100	1/3/45	811726	4440
		300	1/3/45	811732	4518

—optipro— **RCD ADD ON BLOCK**

- Conforms to IEC 60947-2 • Degree of Protection IP 20
- Rated Conditional Short-Circuit Current, I_{cc} 10kA • 35 sq. mm Terminals • Dual Position DIN Clip

DOUBLE POLE

HSN Code: 8536

	Rating (A)	Sensitivity (mA)	Pack	Cat. Nos.	Unit Price (₹)
	6A - 32A	30	30	1/ - /32	811666
100		100	1/ - /32	811668	3260
300		300	1/ - /32	811670	3508
40A & 63A	30	30	1/ - /32	811667	3508
	100	100	1/ - /32	811669	3854
	300	300	1/ - /32	811671	4206

FOUR POLE

HSN Code: 8536

	Rating (A)	Sensitivity (mA)	Pack	Cat. Nos.	Unit Price (₹)
	6A - 32A	30	30	1/ - /16	811672
100		100	1/ - /16	811674	3700
300		300	1/ - /16	811676	3860
40A & 63A	30	30	1/ - /16	811673	3970
	100	100	1/ - /16	811675	4318
	300	300	1/ - /16	811677	4656

—optipro— **ACCESSORIES**

HSN Code: 8538

- Conforms to IEC 60947 - 5 - 1 • Retro Fit Type Clip On Accessory • CE Marked
- Upto Three Number of Accessory on a Modular Device • Common Accessories for Entire Range • Easy To Install

	Item Description	Pack	Cat. Nos.	Unit Price (₹)
	Auxiliary Changeover Switch 1NO	1	811580	828
	Fault Signalling Contact 1NC	1	811581	980
	Shunt Trip 12V to 48V AC/DC	1	811582	1652
	Shunt Trip 110V to 415V AC	1	811583	1652
	Undervoltage 24V & 48V AC/DC	1	811584	1444
	Undervoltage 240V AC	1	811585	1444



DISTRIBUTION BOARDS SUITABLE FOR MIVAN CONSTRUCTION



IP:43 protection



Increased sheet thickness to withstand the concrete pressure



Mechanical impact strength IK09

— optipro —[™]

ALL THAT YOU NEED

— optipro™ — **DISTRIBUTION BOARDS (DBs)**

SPN DB-SINGLE DOOR

HSN Code: 8537

- IP : 30 Protection
- Door Earthing
- Isolated Neutral Bar
- Mechanical Impact Strength IK 08
- Cement Spill Protector

	Ways	Modules	Cat Ref.	Unit Price (₹)
	4	4	811800	1260
	6	6	811801	1320
	8	8	811802	1540
	12	12	811803	1820
	16	16	811804	2260

SPN DB-DOUBLE DOOR

HSN Code: 8537

- IP : 43 Protection
- Door Earthing
- Isolated Neutral Bar
- Mechanical Impact Strength IK 09
- Cement Spill Protector

	Ways	Modules	Cat Ref.	Unit Price (₹)
	4	4	811805	1660
	6	6	811806	1800
	8	8	811807	2100
	10	10	811812	2480
	12	12	811808	2600
	14	14	811810	2900
	16	16	811809	3220
	18	18	811811	3600

SPN DB-DOUBLE DOOR

HSN Code: 8537

- IP : 54 Protection
- Door Earthing
- Isolated Neutral Bar
- Mechanical Impact Strength IK 09
- Cement Spill Protector

	Ways	Modules	Cat Ref.	Unit Price (₹)
	4	4	811824	2800
	6	6	811825	3420
	8	8	811826	3660
	12	12	811828	4720
	16	16	811829	5840

SPN DB-ACRYLIC DOOR

HSN Code: 8537

- IP : 43 Protection
- Door Earthing
- Isolated Neutral Bar
- Cement Spill Protector

	Ways	Modules	Cat Ref.	Unit Price (₹)
	4	4	811816	1940
	6	6	811817	2320
	8	8	811818	2440
	12	12	811819	3080
	16	16	811820	3800

— optipro™ — **DISTRIBUTION BOARDS (DBs)**

TPN DB-SINGLE DOOR

HSN Code: 8537

- IP : 30 Protection
- Door Earthing
- Isolated Neutral Bar
- Mechanical Impact Strength IK 08
- Cement Spill Protector



Ways	Modules	Cat Ref.	Unit Price (₹)
4 Way compact	4 + 12	811832	3240
4 Way	8 + 12	811833	3420
6 Way compact	4 + 18	811834	3960
6 Way	8 + 18	811835	4240
8 Way	8 + 24	811836	5000
12 Way	8 + 36	811837	7200
16 Way	8 + 48	811838	8880

TPN DB-DOUBLE DOOR

HSN Code: 8537

- IP : 43 Protection
- Door Earthing
- Isolated Neutral Bar
- Mechanical Impact Strength IK 09
- Cement Spill Protector



Ways	Modules	Cat Ref.	Unit Price (₹)
4 Way compact	4 + 12	811840	3860
4 Way	8 + 12	811841	4060
6 Way compact	4 + 18	811842	4760
6 Way	8 + 18	811843	5060
8 Way	8 + 24	811844	6080
12 Way	8 + 36	811845	9100
16 Way	8 + 48	811846	11300

TPN DB -DOUBLE DOOR

HSN Code: 8537

- IP : 54 Protection
- Door Earthing
- Isolated Neutral Bar
- Mechanical Impact Strength IK 09
- Cement Spill Protector



Ways	Modules	Cat Ref.	Unit Price (₹)
4 Way compact	4 + 12	811856	7140
4 Way	8 + 12	811857	8080
6 Way compact	4 + 18	811858	9260
6 Way	8 + 18	811859	10100
8 Way	8 + 24	811860	12540
12 Way	8 + 36	811861	17820
16 Way	8 + 48	811862	21300

TPN DB-ACRYLIC DOOR

HSN Code: 8537

- IP : 43 Protection
- Door Earthing
- Isolated Neutral Bar
- Cement Spill Protector



Ways	Modules	Cat Ref.	Unit Price (₹)
4 Way compact	4 + 12	811848	4820
4 Way	8 + 12	811849	5240
6 Way compact	4 + 18	811850	6100
6 Way	8 + 18	811851	6540
8 Way	8 + 24	811852	8140
12 Way	8 + 36	811853	11540
16 Way	8 + 48	811854	13940

— optipro™ — **DISTRIBUTION BOARDS (DBs)**

VTPN MCB DB-SINGLE DOOR

HSN Code: 8537

- IP : 30 Protection
- Door Earthing
- Isolated Neutral Bar
- Mechanical Impact Strength IK 08
- Insulated busbar assembly

	Ways	Modules	Cat Ref.	Unit Price (₹)
	4 Way	8 + 12	811864	9360
	6 Way	8 + 18	811865	10480
	8 Way	8 + 24	811866	11660
	12 Way	8 + 36	811867	14940

VTPN MCB DB-DOUBLE DOOR

- IP : 43 Protection
- Door Earthing
- Isolated Neutral Bar
- Mechanical Impact Strength IK 09
- Insulated busbar assembly

	Ways	Modules	Cat Ref.	Unit Price (₹)
	4 Way	8 + 12	811870	10400
	6 Way	8 + 18	811871	12378
	8 Way	8 + 24	811872	13580
	12 Way	8 + 36	811873	17220

VTPN MCB DB -DOUBLE DOOR

HSN Code: 8537

- IP : 54 Protection
- Door Earthing
- Isolated Neutral Bar
- Mechanical Impact Strength IK 09
- Cement Spill Protector

	Ways	Modules	Cat Ref.	Unit Price (₹)
	4 Way	8 + 12	811882	15400
	6 Way	8 + 18	811883	19460
	8 Way	8 + 24	811884	23660
	12 Way	8 + 36	811885	29760

VTPN MCCB 125A DB-DOUBLE DOOR

HSN Code: 8537

- IP : 43 Protection
- Door Earthing
- Isolated Neutral Bar
- Mechanical Impact Strength IK 09
- Insulated busbar assembly
- Suitable for MCCB's upto 125A as I/C (Frame1)

	Ways	Modules	Cat Ref.	Unit Price (₹)
	4 Way	Optium F1 + 12	811888	12420
	6 Way	Optium F1 + 18	811889	14040
	8 Way	Optium F1 + 24	811890	15020
	12 Way	Optium F1 + 36	811891	20260

VTPN MCCB 125A DB -DOUBLE DOOR

HSN Code: 8537

- IP : 54 Protection
- Door Earthing
- Isolated Neutral Bar
- Mechanical Impact Strength IK 09
- Cement Spill Protector
- Suitable for MCCB's upto 125A as I/C (Frame1)

	Ways	Modules	Cat Ref.	Unit Price (₹)
	4 Way	Optium F1 + 12	812040	21020
	6 Way	Optium F1 + 18	812041	23780
	8 Way	Optium F1 + 24	812042	25440
	12 Way	Optium F1 + 36	812043	34300

— optipro™ — **DISTRIBUTION BOARDS (DBs)**

VTPN MCCB 250A DB-DOUBLE DOOR

HSN Code: 8537

- IP : 43 Protection
- Door Earthing
- Isolated Neutral Bar
- Mechanical Impact Strength IK 09
- Insulated busbar assembly
- Suitable for MCCB's upto 250A as I/C (Frame 2)

	Ways	Modules	Cat Ref.	Unit Price (₹)
	4 Way	Optium F2+ 12	811893	17580
	6 Way	Optium F2+ 18	811894	18680
	8 Way	Optium F2+ 24	811895	20660
	12 Way	Optium F2+ 36	811896	26280

VTPN MCCB 250A DB -DOUBLE DOOR

HSN Code: 8537

- IP : 54 Protection
- Door Earthing
- Isolated Neutral Bar
- Mechanical Impact Strength IK 09
- Cement Spill Protector
- Suitable for MCCB's upto 250A as I/C (Frame 2)

	Ways	Modules	Cat Ref.	Unit Price (₹)
	4 Way	Optium F2+ 12	812045	34100
	6 Way	Optium F2+ 18	812046	36380
	8 Way	Optium F2+ 24	812047	40220
	12 Way	Optium F2+ 36	812048	45180

FLEXI DB-DOUBLE DOOR

HSN Code: 8537

- IP : 43 Protection
- Door Earthing
- Isolated Neutral Bar
- Mechanical Impact Strength IK 09
- Cement Spill Protector

	Ways	Modules	Cat Ref.	Unit Price (₹)
	14 X 2 Row	28	811912	5540
	14 X 3 Row	42	811913	6600
	14 X 4 Row	56	811915	7340

FLEXI DB -DOUBLE DOOR

HSN Code: 8537

- IP : 54 Protection
- Door Earthing
- Isolated Neutral Bar
- Mechanical Impact Strength IK 09
- Cement Spill Protector

	Ways	Modules	Cat Ref.	Unit Price (₹)
	14 X 2 Row	28	812030	9120
	14 X 3 Row	42	812031	11120
	14 X 4 Row	56	812033	12260

— optipro™ — DISTRIBUTION BOARDS (DBs)

7 SEGMENT DB-DOUBLE DOOR

HSN Code: 8537

- IP : 43 Protection
- Door Earthing
- Isolated Neutral Bar
- Mechanical Impact Strength IK 09
- Compartmentalized solution

	Ways	Modules	Cat Ref.	Unit Price (₹)
	4 Way	8 + 12 + 12	811925	10660
	6 Way	8 + 12 + 18	811926	12060
	8 Way	8 + 12 + 24	811927	13860
	12 Way	8 + 12 + 36	811928	17320
	16 Way	8 + 12 + 48	811929	17620

PHASE SELECTOR DB 40A DOUBLE DOOR

HSN Code: 8537

- IP : 43 Protection
- Door Earthing
- 40 A prefitted selector switch
- Mechanical Impact Strength IK 09
- Isolated Neutral Bar

	Ways	Modules	Cat Ref.	Unit Price (₹)
	4 Way	8 + 12	811940	12500
	6 Way	8 + 18	811941	13040
	8 Way	8 + 24	811942	14160
	12 Way	8 + 36	811943	15700

PHASE SELECTOR DB 63A DOUBLE DOOR

HSN Code: 8537

- IP : 43 Protection
- Door Earthing
- 63 A prefitted selector switch
- Mechanical Impact Strength IK 09
- Isolated Neutral Bar

	Ways	Modules	Cat Ref.	Unit Price (₹)
	4 Way	8 + 12	811950	14420
	6 Way	8 + 18	811951	15040
	8 Way	8 + 24	811952	16340
	12 Way	8 + 36	811953	18740

METAL CLAD P&S

HSN Code: 8537

- IP : 30 Protection
- Without MCBs
- Mechanical Impact Strength IK 08

	Ways	Modules	Cat Ref.	Unit Price (₹)
	20A 2P + E	1 Mod	811955	1240
	20A 2P + E	2 Mod	811956	1240
	20A 3P + E	3 Mod	811957	2740
	32A 3P + E	3 Mod	811958	3780

— optipro™ — **DISTRIBUTION BOARDS (DBs)**

TV/TEL DB

HSN Code: 8537

- IP : 43 Protection
- Door Earthing
- Factory fitted KRONE type TV & TEL socket
- Mechanical Impact Strength IK 09
- Isolated & Shrouded Neutral Bar

	Ways	Modules	Cat Ref.	Unit Price (₹)
	8 Way SPN	8	811963	4420
12 Way SPN	12	811964	4980	
16 Way SPN	16	811965	5620	
4 Way TPN	8 + 12	811967	7360	
6 Way TPN	8 + 18	811983	7960	
8 Way TPN	8 + 24	811968	8920	

PPI DB-DOUBLE DOOR

HSN Code: 8537

- IP : 43 Protection
- Door Earthing
- Isolated Neutral Bar for individual phase
- Mechanical Impact Strength IK 09
- Cement Spill Protector

	Ways	Modules	Cat Ref.	Unit Price (₹)
	Hori 4 + 2 Way	8 + 6 + 12	811971	7340
Hori 6 + 2 Way	8 + 6 + 18	811972	9000	
Hori 8 + 2 Way	8 + 6 + 24	811973	10660	
Hori 12 + 2 Way	8 + 6 + 36	811998	13130	
Tier 6 + 2 Way	8 + 6 + 18	811974	8720	
Tier 8 + 2 Way	8 + 6 + 24	811975	10880	
Tier 12 + 2 Way	8 + 6 + 36	811976	13340	

PPI DB-DOUBLE DOOR

HSN Code: 8537

- IP :54 Protection
- Door Earthing
- Isolated Neutral Bar
- Mechanical Impact Strength IK 09
- Cement Spill Protector

	Ways	Modules	Cat Ref.	Unit Price (₹)
	Hori 4 + 2 Way	8 + 6 + 12	812034	14420
Hori 6 + 2 Way	8 + 6 + 18	812035	17680	
Hori 8 + 2 Way	8 + 6 + 24	812036	20040	
Tier 6 + 2 Way	8 + 6 + 18	812037	14620	
Tier 8 + 2 Way	8 + 6 + 24	812038	18260	
Tier 12 + 2 Way	8 + 6 + 36	812039	21240	

PLASTIC P&S

HSN Code: 8537

- IP : 30 Protection
- Without MCBs

	Ways	Modules	Cat Ref.	Unit Price (₹)
	16A 2P + E	2 Mod	811959	2780
32A 2P + E	2 Mod	811960	3060	
32A 3P + N + E	4 Mod	811961	4900	
63A 3P + N + E	4 Mod	811962	12920	

— optipro™ — DISTRIBUTION BOARDS (DBs)

ENCLOSURES

HSN Code: 8537

	Ways	Modules	Cat Ref.	Unit Price (₹)
	1/2 Mod plastic	2	811977	180
	3/4 Mod plastic	4	811978	300
	1 Mod metal	1	811979	440
	2 Mod metal	2	811980	440
	3 Mod metal	3	811981	580
	4 Mod metal	4	811982	580

CABLE END BOX

HSN Code: 8537

- IP : 43 Protection
- Mechanical Impact Strength IK08

Description	Cat Ref.	Unit Price (₹)
CEB SPN DD 4W DB	812000	780
CEB SPN DD 6W DB	812001	840
CEB SPN DD 8W DB	812002	900
CEB SPN DD 10W DB	812003	1000
CEB SPN DD 12W DB	812004	1060
CEB SPN DD 14W DB	812005	1120
CEB SPN DD 16W DB	812006	1260
CEB SPN DD 18W DB	812007	1360
CEB TPN DD 4W 4 POLE I/C DB	812008	960
CEB TPN DD 4W 8 POLE I/C DB or CEB TPN 6W4P I/C DB	812009	1160
CEB TPN DD 6W 8P I/C DB or PPI HORI. DD DB 4+2W	812010	1380
CEB TPN DD 8W DB or PPI HORI. DD DB 6+2W	812011	1700
CEB TPN DD 10W DB or PPI HORI. DD DB 8+2W	812012	1980
CEB TPN DD 12W DB	812013	2320
CEB TPN DD 16W DB	812014	2380
CEB VTPN MCB I/C DB or VTPN MCCB I/C DD DB	812015	1860
CEB FLEXY DD 14 MOD. PER ROW DB	812017	1680
CEB PPI TIER 6+2W	812018	1660
CEB PPI TIER 8+2W	812019	1960
CEB PPI TIER 12+2W	812020	2080

MCCB ENCLOSURE

- Solid Neutral Link for 3 Pole MCCBs

Description	Pack	Cat. Nos.	Unit Price (₹)
Optipro Enclosure for Frame-1 Optium 3 Pole MCCB	1	811984	1660
Optipro Enclosure for Frame-1 Optium 4 Pole MCCB	1	811985	1660
Optipro Enclosure for Frame-2 Optium 3 Pole MCCB	1	811986	2560
Optipro Enclosure for Frame-2 Optium 4 Pole MCCB	1	811987	2560
Optipro Enclosure for Frame-3 Optium 3 Pole MCCB	1	811988	2560
Optipro Enclosure for Frame-3 Optium 4 Pole MCCB	1	811989	2560
Optipro Enclosure for Frame-4 Optium 3 Pole MCCB	1	811990	6380
Optipro Enclosure for Frame-4 Optium 4 Pole MCCB	1	811991	6380

BUSBAR CHAMBER
TPN-Type (Cu-busbar)

HSN Code: 8536

	<p>Solution for safe Power Distribution</p> <ul style="list-style-type: none"> • Step type design • Available in both SPN & TPN configuration 	Item Description	Ingress Protection	Cat Ref.	Unit Price* (₹)
		Spl. 32A Busbar Chamber(Cu)	IP42	CPPI1015	6540
		Spl. 63A Busbar Chamber(Cu)	IP42	CPPI1016	7294
		Spl. 100A Busbar Chamber(Cu)	IP42	CPPI1017	8080
		Spl. 200A Busbar Chamber(Cu)	IP42	CPPI1018	9994
		Spl. 250A Busbar Chamber(Cu)	IP42	CPPI1019	14226
		Spl. 320A Busbar Chamber(Cu)	IP42	CPPI1020	17284
		Spl. 400A Busbar Chamber(Cu)	IP42	CPPI1021	19204
		Spl. 630A Busbar Chamber(Cu)	IP42	CPPI1022	30724

*Contact branch office for IP54 design.

BUSBAR CHAMBER
TPN-Type (Al.Busbar)

HSN Code: 8536

	<p>Solution for safe Power Distribution</p> <ul style="list-style-type: none"> • Step type design • Available in both SPN & TPN configuration 	Item Description	Ingress Protection	Cat Ref.	Unit Price* (₹)
		Spl. 32A Busbar Chambe(Al.)	IP42	CPPI1023	6146
		Spl. 63A Busbar Chambe(Al.)	IP42	CPPI1024	6540
		Spl. 100A Busbar Chambe(Al.)	IP42	CPPI1025	6900
		Spl. 200A Busbar Chambe(Al.)	IP42	CPPI1026	7294
		Spl. 250A Busbar Chambe(Al.)	IP42	CPPI1027	8816
		Spl. 320A Busbar Chambe(Al.)	IP42	CPPI1028	9602
		Spl. 400A Busbar Chambe(Al.)	IP42	CPPI1029	9994
		Spl. 630A Busbar Chambe(Al.)	IP42	CPPI1008	17178

*Contact branch office for IP54 design.

**METAL CLAD PLUG & SOCKET
AC PLUG**

HSN Code: 8536

	Rating	Pack	Cat. Nos.	Unit Price (₹)
	10A 2P+E, 230V AC	1/10/100	810385	158
	20A 2P+E, 230V AC	1/10/100	810386	170
	20A 3P+E, 230V / 415V AC	1/10/100	810387	230
	32A 3P+E, 230V / 415V AC	1/10/100	810388	416

AC SOCKET

HSN Code: 8536

	Rating	Pack	Cat. Nos.	Unit Price (₹)
	10A 2P+E, 230V AC	1/10/100	810389	158
	20A 2P+E, 230V AC	1/10/100	810390	182
	20A 3P+E, 230V / 415V AC	1/10/100	810391	242
	32A 3P+E, 230V / 415V AC	1/10/100	810392	416

TIME SWITCHES

ANALOG TIME SWITCHES (with battery back up)

HSN Code: 9107

	Model Name	Description	Cat Ref.	Unit Price (₹)
	1mod DIN Daily	1P Module, 24 hours program, Programmable every 15 min., backup of 100 hours, current capacity 16A, with 1 changeover (1 CO)	TA916422	3376
	3mod DIN Daily	3P Module, 24 hours program, Programmable every 15 min., backup of 100 hrs., current capacity 16A, with 1 changeover (1 CO)	TA926453	3676
	Front Mounted Daily	Front Mounting, 24 hours program, Programmable every 20 min., back up of 100 hrs., current capacity 16A, with 1 changeover (1 CO)	TA912472	3376
	3mod DIN Weekly	Weekly program, Programmable every 4 hrs., with back up of 100 hrs., current capacity 16A, with 1 changeover (1 CO)	TA926129	4016

ANALOG TIME SWITCHES (without battery back up)

HSN Code: 9107

	Model Name	Description	Cat Ref.	Unit Price (₹)
	3mod DIN Daily	3P Module, 24 hours program, Programmable every 15 min., current capacity 16A, with 1 changeover (1 CO)	TA925450	3102
	Front Mounted Daily	Front Mounting, 24 hours program, Programmable every 20 min., current capacity 16A, with 1 changeover (1 CO)	TA912473	2792

DIGITAL TIME SWITCHES

HSN Code: 9107

	Model Name	Description	Cat Ref.	Unit Price (₹)
	DIN Type Daily / Weekly with 1 CO	Programmable every 1 min., with backup of 6 years, 28 memory locations, current capacity 16A, weekly program, with 1 changeover (1 CO), Total 28 programs	TDA43110	4468
	DIN Type Daily / Weekly with 2 CO	Programmable every 1 min., with backup of 6 years, 28 memory locations, current capacity 16A, weekly program, with 2 changeover (2 CO), Total 14 programs per channel	TDA43111	6706
	DIN Type Astronomical with 1 CO	Astronomical Programmable every 1 min., backup of 6 years, 28 memory locations, current capacity 16A, with 1 changeover (1 CO), Total 28 programs	TDA45163	9300
DIN Type Astronomical with 2 CO	Astronomical Programmable every 1 min., backup of 6 years, 28 memory locations, current capacity 16A, with 2 changeover (2 CO), Total 14 programs per channel	TDA45164	11622	

LIGHT SENSITIVE SWITCHES

HSN Code: 9107

	Model Name	Description	Cat Ref.	Unit Price (₹)
	1mod DIN Light Sensitive	Light sensitive switch with outer sensor, sensitive distance 50m, current capacity 16A & control from 1 lux to 100K lux.	TSA58107	7752

TIMELITE DISTRIBUTION BOARDS

HSN Code: 8537

	Description	Cat Ref.	Unit Price (₹)
	Timelite-16A 3Pole/230V-Analog Time switch	TL016AB0	21800
	Timelite-32A 3Pole/230V-Analog Time switch	TL032AB0	23582
	Timelite-32A 3Pole/230V-Digital Time Switch	TL032DB0	25736
	Timelite-32A 3Pole/230V-Astronomical Time Switch	TL032AS0	30034
	Timelite-40A 3Pole/230V-Analog Time Switch	TL040AB0	25402
	Timelite-40A 3Pole/230V-Digital Time Switch	TL040DB0	27512
	Timelite-40A 3Pole/230V-Astronomical Time Switch	TL040AS0	31814
	Timelite-65A 3Pole/230V-Analog Time Switch	TL065AB0	32518
	Timelite-65A 3Pole/230V-Digital Time Switch	TL065DB0	34668
	Timelite-65A 3Pole/230V-Astronomical Time Switch	TL065AS0	38946
	Timelite-110A 3Pole/230V-Analog Time Switch	TL110AB0	54440
	Timelite-110A 3Pole/230V-Digital Time Switch	TL110DB0	56098
	Timelite-110A 3Pole/230V-Astronomical Time Switch	TL110AS0	60956
The analog time switch which will be used in Timelite DBs is TA926453 The digital time switch which will be used in Timelite DBs is TDA43110 The astronomical time switch which will be used in Timelite DBs is TDA45163			

GSM based SMART Timelite DB's are also available on request.

AUTOMATIC CHANGEOVER WITH CURRENT LIMITER

- As per IEC60947-6-1
- Intelligent micro controller based Design
- RoHS Compliant

HSN Code: 8536

	Rating (A)	Pack	Cat. Nos.	Unit Price (₹)
	SPN 30A Mains 1.5A DG ACCL	1/3/45	810409	1842
	SPN 30A Mains 2.5A DG ACCL	1/3/45	810410	1842
	SPN 30A Mains 3A DG ACCL	1/3/45	810400	1842
	SPN 30A Mains 4A DG ACCL	1/3/45	810401	1842
	SPN 30A Mains 5A DG ACCL	1/3/45	810402	1842
	SPN 30A Mains 6A DG ACCL	1/3/45	810403	1842
	SPN 30A Mains 9A DG ACCL	1/3/45	810404	1842
	SPN 30A Mains 12A DG ACCL	1/3/45	810405	1842
	SPN 30A Mains 15A DG ACCL	1/3/45	810406	1842
	SPN 30A Mains 20A DG ACCL	1/3/45	810407	1842
	SPN 30A Mains 30A DG ACCL	1/3/45	810408	1842



COMPACT SIZE, SAFE TO USE



Wide range
16A to 1250A



Overload short circuit
& ground fault protection



Better clearance
with copper spreaders

— **optium**™ —

ALL THAT YOU NEED

—optium™— **OPTIUM 1.0E (FIXED TM MCCB RANGE)**

- Ics =50% Icu as per IEC 60947-II
- Suitable for isolation
- Class II front face
- Fixed Overload & fixed short circuit setting

HSN Code: 8536

	Frame	Breaking capacity	Rating	3P	Unit Price (₹)	4P	Unit Price (₹)
		F1	10kA	16	830701	2440	830710
	F1	10kA	25	830702	2440	830711	3110
	F1	10kA	32	830703	2440	830712	3110
	F1	10kA	40	830704	2440	830713	3110
	F1	10kA	50	830705	2440	830714	3110
	F1	10kA	63	830706	2440	830715	3110
	F1	10kA	80	830707	2624	830716	3518
	F1	10kA	100	830708	2624	830717	3518
	F1	10kA	125	830709	3866	830718	5344

HSN Code: 8536

	Frame	Breaking capacity	Rating	3P	Unit Price (₹)	4P	Unit Price (₹)
		F1	16kA	16	830001	4142	830015
	F1	16kA	25	830002	4142	830016	5058
	F1	16kA	32	830003	4142	830017	5058
	F1	16kA	40	830004	4142	830018	5058
	F1	16kA	50	830005	4142	830019	5058
	F1	16kA	63	830006	4142	830020	5058
	F1	16kA	80	830007	4264	830021	5494
	F1	16kA	100	830008	4264	830022	5494
	F1	16kA	125	830009	5968	830023	7844

HSN Code: 8536

	Frame	Breaking capacity	Rating	3P	Unit Price (₹)	4P	Unit Price (₹)
		F1	25kA	16	830031	4936	830045
	F1	25kA	25	830032	4936	830046	5958
	F1	25kA	32	830033	4936	830047	5958
	F1	25kA	40	830034	4936	830048	5958
	F1	25kA	50	830035	4936	830049	5958
	F1	25kA	63	830036	4936	830050	5958
	F1	25kA	80	830037	5034	830051	6136
	F1	25kA	100	830038	5034	830052	6136
	F1	25kA	125	830039	6122	830053	8148

HSN Code: 8536

	Frame	Breaking capacity	Rating	3P	Unit Price (₹)	4P	Unit Price (₹)
		F1	36kA	16	830061	6472	830075
	F1	36kA	25	830062	6472	830076	7548
	F1	36kA	32	830063	6472	830077	7548
	F1	36kA	40	830064	6472	830078	7548
	F1	36kA	50	830065	6472	830079	7548
	F1	36kA	63	830066	6472	830080	7548
	F1	36kA	80	830067	6900	830081	7954
	F1	36kA	100	830068	6900	830082	7954
	F1	36kA	125	830069	8644	830083	9182

—optium™— **OPTIUM 1.0 (FIXED TM MCCB RANGE)**

HSN Code: 8536

	Frame	Breaking capacity	Rating	3P	Unit Price (₹)	4P	Unit Price (₹)
	F3	50kA	16	830125	8208	830145	9978
	F3	50kA	25	830126	8208	830146	9978
	F3	50kA	32	830127	8208	830147	9978
	F3	50kA	40	830128	8208	830148	9978
	F3	50kA	50	830129	8208	830149	9978
	F3	50kA	63	830130	8208	830150	9978
	F3	50kA	80	830131	8452	830151	10280
	F3	50kA	100	830132	8452	830152	10280
	F3	50kA	125	830133	9860	830153	12754

HSN Code: 8536

	Frame	Breaking capacity	Rating	3P	Unit Price (₹)	4P	Unit Price (₹)
	F2	16kA	160	830090	6528	830095	9334
	F2	16kA	200	830091	8328	830096	10842
	F2	16kA	250	830092	9190	830097	11452
	F2	25kA	160	830100	7766	830105	9866
	F2	25kA	200	830101	10956	830106	12622
	F2	25kA	250	830102	12850	830107	15826
	F2	36kA	160	830110	9780	830115	12226
	F2	36kA	200	830111	11616	830116	15090
F2	36kA	250	830112	15444	830117	20892	

HSN Code: 8536

	Frame	Breaking capacity	Rating	3P	Unit Price (₹)	4P	Unit Price (₹)
	F3	50kA	160	830134	10716	830154	15148
	F3	50kA	200	830135	12310	830155	18640
F3	50kA	250	830136	18730	830156	22684	

HSN Code: 8536

	Frame	Breaking capacity	Rating	3P	Unit Price (₹)	4P	Unit Price (₹)
	F4	36kA	315	830165	22080	830175	25946
	F4	36kA	400	830166	23336	830176	26882
	F4	36kA	500	830167	26112	830177	30514
F4	36kA	630	830168	27678	830178	32760	

HSN Code: 8536

	Frame	Breaking capacity	Rating	3P	Unit Price (₹)	4P	Unit Price (₹)
	F4	50kA	315	830185	23410	830195	27756
	F4	50kA	400	830186	25550	830196	29980
	F4	50kA	500	830187	26970	830197	32222
F4	50kA	630	830188	28590	830198	33388	

HSN Code: 8536

	Frame	Breaking capacity	Rating	3P	MRP	4P	MRP
F5	50kA	800	830200	37998	830201	48596	

—optium™— **OPTIUM 1.1 (FIXED TM MCCB RANGE)**

- Ics = 100% Icu as per IEC 60947-II
- Suitable for isolation
- Class II front face
- Fixed Overload & fixed short circuit setting

HSN Code: 8536

NEW



Frame	Breaking capacity	Rating	3P	Unit Price (₹)	4P	Unit Price (₹)
F1	16kA	32	840003	4310	840017	5768
F1	16kA	40	840004	4310	840018	5768
F1	16kA	63	840006	4310	840020	5768
F1	16kA	80	840007	4436	840021	6050
F1	16kA	100	840008	4436	840022	6050
F1	16kA	125	840009	6224	840023	8444
F1	25kA	32	840033	5386	840047	6626
F1	25kA	40	840034	5386	840048	6626
F1	25kA	63	840036	5386	840050	6626
F1	25kA	80	840037	5542	840051	6754
F1	25kA	100	840038	5542	840052	6754
F1	25kA	125	840039	6412	840053	9474
F2	16kA	160	840090	6868	840095	10340
F2	16kA	200	840091	8622	840096	11556
F2	16kA	250	840092	9828	840097	13248
F2	25kA	160	840100	8234	840105	10880
F2	25kA	200	840101	11218	840106	13884
F2	25kA	250	840102	14936	840107	18122

—optium™— **OPTIUM 2.0 (ADJUSTABLE THERMAL SETTING MCCB)**

- Conforms to IEC 60947-II
- Adjustable Overload Setting $I_r = (0.8 \text{ to } 1.0) \times I_n$
- Ics = 100% Icu
- Class II front face
- Short Circuit setting fixed
- Suitable for isolation

HSN Code: 8536



Frame	Breaking capacity	Rating	3P	Unit Price (₹)	4P	Unit Price (₹)
F1	16kA	25	830222	4386	830236	5914
F1	16kA	32	830223	4386	830237	5914
F1	16kA	40	830224	4386	830238	5914
F1	16kA	50	830225	4386	830239	5914
F1	16kA	63	830226	4386	830240	5914
F1	16kA	80	830227	4756	830241	6236
F1	16kA	100	830228	4756	830242	6236
F1	16kA	125	830229	6428	830243	8690

HSN Code: 8536



Frame	Breaking capacity	Rating	3P	Unit Price (₹)	4P	Unit Price (₹)
F1	25kA	25	830252	5500	830266	6924
F1	25kA	32	830253	5500	830267	6924
F1	25kA	40	830254	5500	830268	6924
F1	25kA	50	830255	5500	830269	6924
F1	25kA	63	830256	5500	830270	6924
F1	25kA	80	830257	5660	830271	7264
F1	25kA	100	830258	5660	830272	7264
F1	25kA	125	830259	6550	830273	9750

HSN Code: 8536



Frame	Breaking capacity	Rating	3P	Unit Price (₹)	4P	Unit Price (₹)
F2	16kA	160	830280	7204	830285	10606
F2	16kA	200	830281	8976	830286	11884
F2	16kA	250	830282	10390	830287	14040
F2	25kA	160	830290	9206	830295	12198
F2	25kA	200	830291	11784	830296	15204
F2	25kA	250	830292	15754	830297	19702

—optium™— **OPTIUM 2.0 (ADJUSTABLE TM MCCB RANGE)**

- Ics =100% Icu as per IEC 60947-II
- Class II front face
- Suitable for isolation
- Adjustable Overload Setting Ir =(0.8 to 1.0)×In
- Adjustable Short Circuit Setting Isd =[5 -10]×In

HSN Code: 8536

	Frame	Breaking capacity	Rating	3P		4P	
				Unit Price (₹)		Unit Price (₹)	
	F3	36kA	16	830305	7576	830325	10574
	F3	36kA	25	830306	7576	830326	10574
	F3	36kA	32	830307	7576	830327	10574
	F3	36kA	40	830308	7576	830328	10574
	F3	36kA	50	830309	7576	830329	10574
	F3	36kA	63	830310	7576	830330	10574
	F3	36kA	80	830311	7724	830331	10884
	F3	36kA	100	830312	7724	830332	10884
	F3	36kA	125	830313	9540	830333	12194

HSN Code: 8536

	Frame	Breaking capacity	Rating	3P		4P	
				Unit Price (₹)		Unit Price (₹)	
	F3	50kA	16	830345	10100	830365	12072
	F3	50kA	25	830346	10100	830366	12072
	F3	50kA	32	830347	10100	830367	12072
	F3	50kA	40	830348	10100	830368	12072
	F3	50kA	50	830349	10100	830369	12072
	F3	50kA	63	830350	10100	830370	12072
	F3	50kA	80	830351	10304	830371	12192
	F3	50kA	100	830352	10304	830372	12192
	F3	50kA	125	830353	11338	830373	14554

HSN Code: 8536

	Frame	Breaking capacity	Rating	3P		4P	
				Unit Price (₹)		Unit Price (₹)	
	F3	36kA	160	830314	12532	830334	15060
	F3	36kA	200	830315	14052	830335	19650
	F3	36kA	250	830316	18458	830336	25732

HSN Code: 8536

	Frame	Breaking capacity	Rating	3P		4P	
				Unit Price (₹)		Unit Price (₹)	
	F3	50kA	160	830354	12988	830374	16380
	F3	50kA	200	830355	15152	830375	20774
	F3	50kA	250	830356	21508	830376	26836

HSN Code: 8536

	Frame	Breaking capacity	Rating	3P		4P	
				Unit Price (₹)		Unit Price (₹)	
	F4	25kA	315	830385	19630	830387	24722
	F4	25kA	400	830386	20098	830388	26970
	F4	36kA	315	830390	23588	830395	29014
	F4	36kA	400	830391	25094	830396	31240
	F4	36kA	500	830392	29834	830397	36990
	F4	36kA	630	830393	32412	830398	41434
	F4	50kA	315	830400	25186	830405	31732
	F4	50kA	400	830401	26882	830406	33322
	F4	50kA	500	830402	30792	830407	39068
	F4	50kA	630	830403	33290	830408	43342

—optium™— **OPTIUM 2.0 (ADJUSTABLE TM MCCB RANGE)**

HSN Code: 8536

	Frame	Breaking capacity	Rating	3P	Unit Price (₹)	4P	Unit Price (₹)
	F5	36kA	800	830410	38448	830413	47146
	F5	36kA	1000	830411	55370	830414	63338
	F5	36kA	1250	830412	64042	830415	76110
	F5	50kA	800	830416	39580	830419	57520
	F5	50kA	1000	830417	68836	830420	75292
	F5	50kA	1250	830418	75920	830421	87208

—optium™— **OPTIUM 2.1 (ELECTRONIC / MICRO -PROCESSOR MCCB RANGE)**

- Ics =100% Icu as per IEC 60947-II
- Class II front face
- Suitable for isolation
- Adjustable Overload Setting Ir = 0.4 - 1 x In
- Adjustable Short circuit Current Setting Isd = 1.5 - 10 x Ir

HSN Code: 8536

	Frame	Breaking capacity	Rating	3P	Unit Price (₹)	4P	Unit Price (₹)
	F3	36kA	40	830430	15820	830440	19924
	F3	36kA	100	830431	16108	830441	20286
	F3	36kA	160	830432	19690	830442	23672
	F3	36kA	250	830433	24844	830443	30134
	F3	50kA	40	830450	17690	830460	21240
	F3	50kA	100	830451	18866	830461	22672
	F3	50kA	160	830452	21468	830462	26250
	F3	50kA	250	830453	28238	830463	34602

—optium™— **OPTIUM 2.1 (ELECTRONIC / MICRO -PROCESSOR MCCB RANGE)**

- Ics =100% Icu as per IEC 60947-II
- Class II front face
- Suitable for isolation
- Transparent cover for trip unit as standard
- Adjustable Neutral pole protection -N,N/2 & Off for 4 pole MCCB
- Innovative front indication LED's(Ready, Overload pre-alarm & Overload)
- Adjustable Overload Setting Ir = 0.4 - 1 x In ; Tr = 3-30 sec
- Adjustable Short circuit Current Setting Isd = 1.5 - 10 Ir ; Tsd (I=K) = 0-500 ms; Tsd (I2t=K) = 0-500 ms

HSN Code: 8536

	Frame	Breaking capacity	Rating	3P	Unit Price (₹)	4P	Unit Price (₹)
	F4	36kA	400	830510	30000	830512	39562
	F4	36kA	630	830511	33804	830513	42950
	F4	50kA	400	830514	37088	830516	47166
F4	50kA	630	830515	38410	830517	49792	

HSN Code: 8536

	Frame	Breaking capacity	Rating	3P	Unit Price (₹)	4P	Unit Price (₹)
	F5	36kA	800	830540	54846	830542	66504
	F5	36kA	1250	830541	82476	830543	105072
	F5	50kA	800	830544	58554	830546	73048
F5	50kA	1250	830545	100686	830547	139194	

—optium™— **OPTIUM 2.2 (WITH ELECTRONIC / MICRO PROCESSOR RELEASE)**

- Ics =100% Icu as per IEC 60947-II
- Class II front face
- Suitable for isolation
- Adjustable Overload Setting Ir = 0.4 - 1 x In
- Adjustable Short circuit Current Setting Isd = 1.5 - 10 x Ir
- Ground fault Setting:- Ig = 0.2 - 1 x In

HSN Code: 8536

	Frame	Breaking capacity	Rating	3P	Unit Price (₹)	4P	Unit Price (₹)
	F3	36kA	40	830470	18804	830480	23502
	F3	36kA	100	830471	19308	830481	24132
	F3	36kA	160	830472	21692	830482	26876
	F3	36kA	250	830473	27718	830483	34106
	F3	50kA	40	830490	20488	830500	24788
	F3	50kA	100	830491	21036	830501	25116
	F3	50kA	160	830492	24100	830502	29262
	F3	50kA	250	830493	31330	830503	37728

—optium™— **OPTIUM 2.2 (ELECTRONIC / MICRO -PROCESSOR MCCB RANGE)**

- Ics =100% Icu as per IEC 60947-II
- Class II front face
- Suitable for isolation
- Adjustable Neutral pole protection –N,N/2 & Off for 4 pole MCCB
- Innovative front indication LED's(Ready, Overload pre-alarm & Overload)
- Adjustable Overload Setting Ir = 0.4 - 1 x In ; Tr = 3-30 sec
- Adjustable Short circuit Current Setting Isd = 1.5 - 10 Ir ; Tsd (I=K) = 0-500 ms; Tsd (I2t=K) = 0-500 ms
- Ground fault Setting:- Ig = 0.2 - 1 x In ; Tg = 0.1 - 1 s

HSN Code: 8536

	Frame	Breaking capacity	Rating	3P	Unit Price (₹)	4P	Unit Price (₹)
	F4	36kA	400	830520	39894	830522	47300
	F4	36kA	630	830521	45592	830523	58128
	F4	50kA	400	830524	44752	830526	51526
	F4	50kA	630	830525	50582	830527	64548

HSN Code: 8536

	Frame	Breaking capacity	Rating	3P	Unit Price (₹)	4P	Unit Price (₹)
	F5	36kA	800	830550	68692	830552	86770
	F5	36kA	1250	830551	91592	830553	119912
	F5	50kA	800	830554	81952	830556	100836
	F5	50kA	1250	830555	107256	830557	146098

—optium™— **ACCESSORIES**

HSN Code: 8538

	Product	Frame	Cat Ref.	Unit Price (₹)
	Auxiliary contact	F1 F2 F3	830691	970
	Alarm Contact	F1 F2 F3	830692	970
	Auxiliary contact / Alarm Contact	F4-F5	830693	1272
	Auxiliary contact / Alarm Contact	F1 F2 F3	830694	1454

HSN Code: 8538

	Product	Frame	Cat Ref.	Unit Price (₹)
	"Shunt trip 24 V AC/DC"	F1 F2 F3	830602	1176
	"Shunt trip 110 V AC/DC"	F1 F2 F3	830603	1176
	"Shunt trip 230 V AC/DC"	F1 F2 F3	830604	1176
	"Shunt trip 415 V AC/DC"	F1 F2 F3	830605	1176
	"Shunt trip 24 V AC/DC"	F4 F5	830642	2160
	"Shunt trip 110 V AC/DC"	F4 F5	830643	2160
	"Shunt trip 230 V AC/DC"	F4 F5	830644	2160
	"Shunt trip 415 V AC/DC"	F4 F5	830645	2160

HSN Code: 8538

	Product	Frame	Cat Ref.	Unit Price (₹)
	"Undervoltage 24 V DC"	F1 F2 F3	830606	1802
	"Undervoltage 110V AC"	F1 F2 F3	830607	1802
	"Undervoltage 230V AC"	F1 F2 F3	830608	1802
	"Undervoltage 415V AC"	F1 F2 F3	830609	1802
	"Undervoltage 24 V DC"	F4 F5	830646	1920
	"Undervoltage 110V AC"	F4 F5	830647	1920
	"Undervoltage 230V AC"	F4 F5	830648	1920
	"Undervoltage 415V AC"	F4 F5	830649	1920

—optium™— **ACCESSORIES**

HSN Code: 8538



Product	Frame	Cat Ref.	Unit Price (₹)
Rotary Handle Direct	F1	830611	1380
Rotary Handle vary-Depth	F1	830612	1380
Rotary Handle Direct	F2 F3	830626	1620
Rotary Handle vary-Depth	F2 F3	830627	1620
Rotary Handle Direct	F4	830651	1920
Rotary Handle vary-Depth	F4	830652	1920
Rotary Handle Direct	F5	830671	3760
Rotary Handle vary-Depth	F5	830672	3760

HSN Code: 8538



Product	Frame	Cat Ref.	Unit Price (₹)
Ronis lock Direct RH	F1 F2 F3	830613	1618
Ronis lock Vary-Depth RH	F1 F2 F3	830614	1618
Ronis lock Vary-Depth RH	F4	830653	2182

HSN Code: 8538



Product	Frame	Cat Ref.	Unit Price (₹)
Padlock Off position	F1 F2 F3	830615	2204
Padlock Off position	F4	830654	2204
Padlock Off position	F5	830674	2204

HSN Code: 8538



Product	Frame	Cat Ref.	Unit Price (₹)
Phase insulators 3P	F1 F2	830616	POR
Phase insulators 3P	F3	830628	POR
Phase insulators 3P	F4	830655	POR
Phase insulators 3P	F5	830675	POR
Phase insulators 4P	F1 F2	830617	POR
Phase insulators 4P	F3	830629	POR
Phase insulators 4P	F4	830656	POR
Phase insulators 4P	F5	830676	POR

HSN Code: 8538



Product	Frame	Cat Ref.	Unit Price (₹)
Terminal cover 3P	F4	830657	POR
Terminal cover 3P	F5	830677	POR
Terminal cover 4P	F4	830658	POR
Terminal cover 4P	F5	830678	POR
Terminal shield 3P	F5	830679	POR
Terminal shield 4P	F5	830680	POR

—optium™— **ACCESSORIES**

HSN Code: 8538

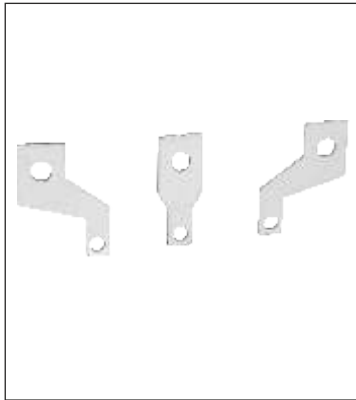

Product	Frame	Cat Ref.	Unit Price (₹)
Spreaders 3P	F1	830618	398
Spreaders 4P	F1	830619	580
Spreaders 3P	F2 F3	830632	1058
Spreaders 4P	F2 F3	830633	2116
Spreaders 3P	F4	830659	3386
Spreaders 4P	F4	830660	4938
Spreaders 3P 800/1000A	F5	830681	8746
Spreaders 4P 800/1000A	F5	830682	12824
Spreaders 3P 1250A	F5	830685	9096
Spreaders 4P 1250A	F5	830686	13408

HSN Code: 8538



Product	Frame	Cat Ref.	Unit Price (₹)
Cages 3P upto 50A	F1	830620	POR
Cages 4P upto 50A	F1	830621	POR
Cages 3P 63 to 100A	F1	830622	POR
Cages 4P 63 to 100A	F1	830623	POR
Cages 3P 125A	F1	830624	POR
Cages 4P 125A	F1	830625	POR
Cages 3P	F2	830630	POR
Cages 4P	F2	830631	POR
Cages 3P	F3	830634	POR
Cages 4P	F3	830635	POR
Cages 3P	F4	830661	POR
Cages 4P	F4	830662	POR
Cages 3P	F5	830683	POR
Cages 4P	F5	830684	POR



READY TO USE-SAFE-RELIABLE ELECTRICAL SUB-DISTRIBUTION PANEL



Designed as per
IEC 61439-2



Available in 4W,
6W, 8W, 12W



Ready to use solution
with MCCB incomer and
multi outgoing device

LOAD BANK

LOAD BANK (MCCB Distribution Panel)

HSN Code: 8536

- Versatile Solution to match application needs
- Available in single Door & Double Door design
- Range : 4, 6, 8 & 12 ways
- Suitable for 3Ph - 3 Wire / 3 Phase 4 Wire - 3P/4P circuits

	Rating Amps	Incomer	Outgoing	Cat Ref.	Unit Price (₹)
	Loadbank DB 250A 4W SD TP O/G	Optium F2 MCCB - 1 No.	Optium F1 MCCB - 4 Nos.	LTSF24###	111512
	Loadbank DB 250A 6W SD TP O/G	Optium F2 MCCB - 1 No.	Optium F1 MCCB - 6 Nos.	LTSF26###	124888
	Loadbank DB 250A 8W SD TP O/G	Optium F2 MCCB - 1 No.	Optium F1 MCCB - 8 Nos.	LTSF28###	143466
	Loadbank DB 250A 12W SD TP O/G	Optium F2 MCCB - 1 No.	Optium F1 MCCB - 12 Nos.	LTSF22###	169556
	Loadbank DB 250A 4W DD TP O/G	Optium F2 MCCB - 1 No.	Optium F1 MCCB - 4 Nos.	LTDF24###	116356
	Loadbank DB 250A 6W DD TP O/G	Optium F2 MCCB - 1 No.	Optium F1 MCCB - 6 Nos.	LTDF26###	130222
	Loadbank DB 250A 8W DD TP O/G	Optium F2 MCCB - 1 No.	Optium F1 MCCB - 8 Nos.	LTDF28###	151156
	Loadbank DB 250A 12W DD TP O/G	Optium F2 MCCB - 1 No.	Optium F1 MCCB - 12 Nos.	LTDF22###	178134

LOADBANK (MCCB Distribution Panel)

HSN Code: 8536

	Rating Amps	Incomer	Outgoing	Cat Ref.	Unit Price (₹)
	Loadbank DB 250A 4W SD FP O/G	Optium F2 MCCB - 1 No.	Optium F1 MCCB - 4 Nos.	LFSF24###	118222
	Loadbank DB 250A 6W SD FP O/G	Optium F2 MCCB - 1 No.	Optium F1 MCCB - 6 Nos.	LFSF26###	136222
	Loadbank DB 250A 8W SD FP O/G	Optium F2 MCCB - 1 No.	Optium F1 MCCB - 8 Nos.	LFSF28###	159378
	Loadbank DB 250A 12W SD FP O/G	Optium F2 MCCB - 1 No.	Optium F1 MCCB - 12 Nos.	LFSF22###	187066
	Loadbank DB 250A 4W DD FP O/G	Optium F2 MCCB - 1 No.	Optium F1 MCCB - 4 Nos.	LFDF24###	123200
	Loadbank DB 250A 6W DD FP O/G	Optium F2 MCCB - 1 No.	Optium F1 MCCB - 6 Nos.	LFDF26###	141822
	Loadbank DB 250A 8W DD FP O/G	Optium F2 MCCB - 1 No.	Optium F1 MCCB - 8 Nos.	LFDF28###	167378
	Loadbank DB 250A 12W DD FP O/G	Optium F2 MCCB - 1 No.	Optium F1 MCCB - 12 Nos.	LFDF22###	196312

LOADBANK (MCCB Distribution Panel)

HSN Code: 8536

	Rating Amps	Incomer	Outgoing	Cat Ref.	Unit Price (₹)
	Loadbank DB 400A 4W SD TP O/G	Optium F4 MCCB - 1 No.	Optium F1 MCCB - 4 Nos.	LFST44###	161600
	Loadbank DB 400A 6W SD TP O/G	Optium F4 MCCB - 1 No.	Optium F1 MCCB - 6 Nos.	LFST46###	173866
	Loadbank DB 400A 8W SD TP O/G	Optium F4 MCCB - 1 No.	Optium F1 MCCB - 8 Nos.	LFST48###	191778
	Loadbank DB 400A 12W SD TP O/G	Optium F4 MCCB - 1 No.	Optium F1 MCCB - 12 Nos.	LFST42###	217244
	Loadbank DB 400A 4W DD TP O/G	Optium F4 MCCB - 1 No.	Optium F1 MCCB - 4 Nos.	LFDT44###	168578
	Loadbank DB 400A 6W DD TP O/G	Optium F4 MCCB - 1 No.	Optium F1 MCCB - 6 Nos.	LFDT46###	180888
	Loadbank DB 400A 8W DD TP O/G	Optium F4 MCCB - 1 No.	Optium F1 MCCB - 8 Nos.	LFDT48###	199288
	Loadbank DB 400A 12W DD TP O/G	Optium F4 MCCB - 1 No.	Optium F1 MCCB - 12 Nos.	LFDT42###	225644

LOADBANK (MCCB Distribution Panel)

HSN Code: 8536

	Rating Amps	Incomer	Outgoing	Cat Ref.	Unit Price (₹)
	Loadbank DB 400A 4W SD FP O/G	Optium F4 MCCB - 1 No.	Optium F1 MCCB - 4 Nos.	LFSF44###	168844
	Loadbank DB 400A 6W SD FP O/G	Optium F4 MCCB - 1 No.	Optium F1 MCCB - 6 Nos.	LFSF46###	185866
	Loadbank DB 400A 8W SD FP O/G	Optium F4 MCCB - 1 No.	Optium F1 MCCB - 8 Nos.	LFSF48###	207778
	Loadbank DB 400A 12W SD FP O/G	Optium F4 MCCB - 1 No.	Optium F1 MCCB - 12 Nos.	LFSF42###	233956
	Loadbank DB 400A 4W DD FP O/G	Optium F4 MCCB - 1 No.	Optium F1 MCCB - 4 Nos.	LFDF44###	175600
	Loadbank DB 400A 6W DD FP O/G	Optium F4 MCCB - 1 No.	Optium F1 MCCB - 6 Nos.	LFDF46###	193200
	Loadbank DB 400A 8W DD FP O/G	Optium F4 MCCB - 1 No.	Optium F1 MCCB - 8 Nos.	LFDF48###	215644
	Loadbank DB 400A 12W DD FP O/G	Optium F4 MCCB - 1 No.	Optium F1 MCCB - 12 Nos.	LFDF42###	242978

* Above prices are of complete enclosure with switchgear and digital metering arrangement as per standard GA Drwg. only for any change please contact nearest branch office implication.
Code details : L=Loadbank;T=TP Outgoing;S=Single Door;F2=Incomer MCCB Frame;4=4W;###=Variable code according to resp. configuration/Drwg. No.

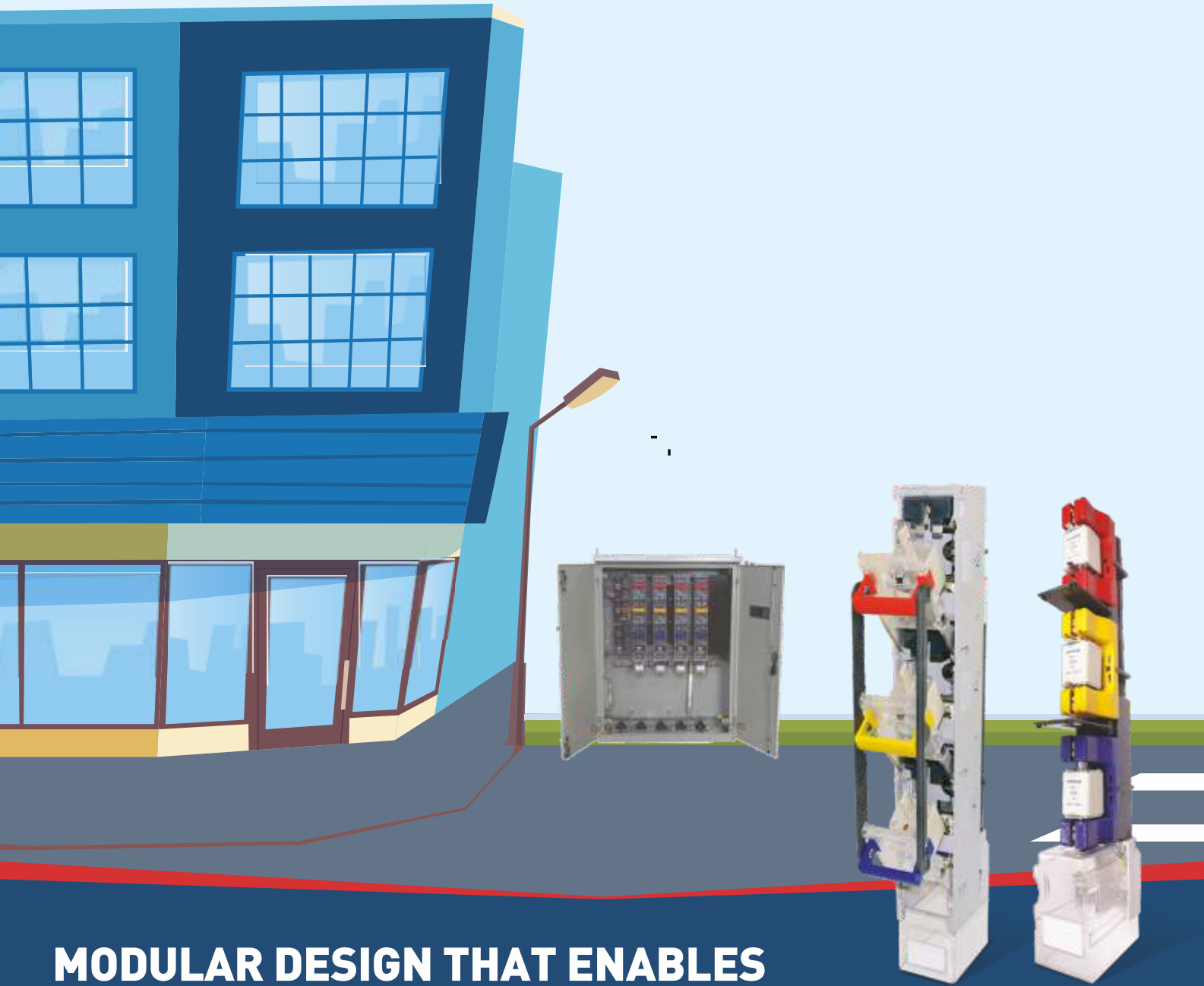

MODULAR DESIGN THAT ENABLES SAFE DISCONNECTION



Complies to
IEC 60947-3



Rated current 250A,
400A and 630A



Modular Construction with
the same dimensions for
all frame sizes

VERTICAL FUSE SWITCHES

HRC FUSE LINKS & BASES

BOLTED TYPE (BS) BREAKING CAPACITY ≥ 80kA 500 V AC 50 Hz.

HSN Code: 8536

	Rating	Type	Cat Ref.	Tag Type	Unit Price (₹)	Unit/Carton
		2, 4, 6, 8, 10, 16A	FGN	IEFGN***	Offset	78
	20, 25, 32A	FGN	IEFGN***	Offset	88	20
	2, 4, 6, 10, 16, 20, 25, 32A	FSA	IEFSA***	Offset	118	10
	35, 40, 50, 63A	FSS	IEFSS***	Offset	132	10
	50, 63, 80, 100, 125, 160A	FSDCP	IEDCP***	Offset	280	10
	100, 125, 160, 200, 250A	FSFP	IESFP***	Offset	404	3
	50, 63, 80, 100, 125A	FSDC	IESDC***	Central	280	10
	100, 125, 160, 200, 250A	FSF	IEFSF***	Central	412	3
	225, 250, 300, 315, 320A	FSK	IEFSK***	Central	596	3
	355, 400A	FMF	IEFMF***	Central	1152	3
	355, 400, 450, 500, 560, 600, 630A	FTS	IEFTS***	Central	1328	1
	355, 400, 450, 500, 560A	FTM	IEFTM***	2 Central	1714	1
	600, 630A	FTM	IEFTM***	2 Central	2358	1

DIN TYPE BREAKING CAPACITY ≥ 80kA 500 V AC 50 Hz.

HSN Code: 8536

	Rating Amps	Type	Cat Ref.	Unit Price (₹)	Unit/Carton
		2, 4, 6, 10, 16, 20, 25, 32, 50, 63A	Size 000	IWS00***	352
	2, 4, 6, 10, 16, 20, 25, 32, 36, 40, 50, 63A	Size 00	IW000***	374	6
	80, 100A		IW000***	390	6
	125, 160A		IW000***	414	6
	32, 36, 50, 63, 80, 100, 125, 160, 200A	Size 01	IW001***	684	3
	250A		IW001***	778	3
	100, 125, 160, 200, 250, 315A	Size 02	IW002***	1004	3
	400A		IW002***	1086	3
	315, 355, 400, 425A	Size 03	IW003***	1378	3
	500, 630A		IW003***	1604	3

* Note HRC fuses with SC breaking capacity 120kA are available on request.

CYLINDRICAL TYPE (IFRH) BREAKING CAPACITY > 80kA 415 V AC.

HSN Code: 8536

	Rating	Cat Ref.	Unit Price (₹)
		2 to 25A	IFRHO***
	32 to 40A	IFRHO***	156
	50A	IFRH0050	288
	63A	IFRH0063	296
	Fuse Holder Fr type (2 to 63A)	IFR00***	276

FUSE FITTINGS FOR BOLTED (BS) TYPE

HSN Code: 8536

	Rating	Front Connection	Unit Price (₹)	Back Busbar Connection	Unit Price (₹)	Unit/Carton
		20A	BFFC 0020	168	BFBC 0020	180
	32A	BFFC 0032	294	BFBC 0032	306	10
	63A	BFFC 0063	424	BFBC 0063	446	5
	100A	BFFC 0100	1090	BFBC 0100	1122	3
	20A (Stud Type)			BFFCS 020	242	1

FUSE BASES FOR DIN TYPE HRC FUSE LINKS

HSN Code: 8536

	Rating Amps	Suitable for	Cat Ref.	Unit Price (₹)	Unit/Carton
		6-160A	Size - 00	IWFB0***	480
	32-250A	Size - 1	IWFB1***	916	2
	100-400A	Size - 2	IWFB2***	1368	2
	315-630A	Size - 3	IWFB3***	1736	2

SWITCH DISCONNECTOR FUSES

HSN Code: 8536

Rated Current	Type	IN OPEN EXECUTION*		IN SHEET STEEL ENCLOSURE		Recommended HRC Fuse Indo Asian Make
		Cat Ref.	Unit Price (₹)	Cat Ref.	Unit Price (₹)	
32A BS	TPN	INO1A032	1934	INS1A032	3866	FSA
63A BS	TPN	INO1A063	2676	INS1A063	4926	FSS
100A BS	TPN	INO1A100	5332	INS1A100	7226	FSDCP
125A BS	TPN	INO1A125	6466	INS1A125	9662	FSDCP
160A BS	TPN	INO1A160	7828	INS1A160	10788	FSDCP
200A BS	TPN	INO1A200	9738	INS1A200	12328	FSF
250A BS	TPN	INO1A250	10994	INS1A250	14508	FSF
315A BS	TPN	INO1A315	14088	INS1A315	18116	FSK
400A BS	TPN	INO1A400	17486	INS1A400	21626	FMF
32A BS	TPSN	INO1B032	2434	INS1B032	4200	FSA
63A BS	TPSN	INO1B063	3090	INS1B063	4970	FSS
100A BS	TPSN	INO1B100	7164	INS1B100	9298	FSDCP
125A BS	TPSN	INO1B125	7844	INS1B125	9952	FSDCP
160A BS	TPSN	INO1B160	9812	INS1B160	12862	FSDCP
200A BS	TPSN	INO1B200	11174	INS1B200	14230	FSF
250A BS	TPSN	INO1B250	12184	INS1B250	15978	FSF
315A BS	TPSN	INO1B315	16914	INS1B315	22320	FSK
400A BS	TPSN	INO1B400	20010	INS1B400	23216	FMF

* Price Does Not Include HRC Fuse

HSN Code: 8536

Rated Current	Type	IN OPEN EXECUTION*		IN SHEET STEEL ENCLOSURE		Recommended HRC Fuse Indo Asian Make
		Cat Ref.	Unit Price (₹)	Cat Ref.	Unit Price (₹)	
32A DIN	TPN	IN10A032	1916	IN1SA032	3756	Size 000
63A DIN	TPN	IN10A063	2660	IN1SA063	4730	Size 000
100A DIN	TPN	IN10A100	5296	IN1SA100	7148	Size 00
125A DIN	TPN	IN10A125	6750	IN1SA125	9634	Size 00
160A DIN	TPN	IN10A160	8122	IN1SA160	10584	Size 00
200A DIN	TPN	IN10A200	10140	IN1SA200	12046	Size 01
250A DIN	TPN	IN10A250	11360	IN1SA250	14500	Size 01
315A DIN	TPN	IN10A315	14592	IN1SA315	18050	Size 02
400A DIN	TPN	IN10A400	17988	IN1SA400	21396	Size 02
630A DIN	TPN	IN10A630	28914	IN1SA630	31140	Size 03
800A DIN	TPN	IN10A800	33606	IN1SA800	43668	Size 03
32A DIN	TPSN	IN10B032	2822	IN1SB032	3828	Size 000
63A DIN	TPSN	IN10B063	3252	IN1SB063	4134	Size 000
100A DIN	TPSN	IN10B100	7288	IN1SB100	8244	Size 00
125A DIN	TPSN	IN10B125	8076	IN1SB125	8874	Size 00
160A DIN	TPSN	IN10B160	9462	IN1SB160	11866	Size 00
200A DIN	TPSN	IN10B200	10996	IN1SB200	12516	Size 01
250A DIN	TPSN	IN10B250	12594	IN1SB250	14340	Size 01
315A DIN	TPSN	IN10B315	16856	IN1SB315	19512	Size 02
400A DIN	TPSN	IN10B400	19588	IN1SB400	24366	Size 02
630A DIN	TPSN	IN10B630	31448	IN1SB630	33324	Size 03
800A DIN	TPSN	IN10B800	36364	IN1SB800	48032	Size 03

* Price Does Not Include HRC Fuse

SWITCH DISCONNECTOR 4 POLE

HSN Code: 8536

Rated Current	IN OPEN EXECUTION*		IN SHEET STEEL ENCLOSURE	
	Cat Ref.	Unit Price (₹)	Cat Ref.	Unit Price (₹)
32A	IN1SD032	2560	IN1ED032	3656
63A	IN1SD063	3076	IN1ED063	4320
100A	IN1SD100	4768	IN1ED100	7848
125A	IN1SD125	5984	IN1ED125	8906
160A	IN1SD160	7498	IN1ED160	10744
200A	IN1SD200	8350	IN2ED200	12912
250A	IN1SD250	10818	IN2ED250	17034
315A	IN1SD315	11758	IN3ED315	18618
400A	IN1SD400	13800	IN3ED400	21828
630A	IN1SD630	19152	IN4ED630	31844
800A	IN1SD800	22810	IN4ED800	36886

*Prices of 3 Pole SD is available on Request.

**Ambidex CHANGEOVER SWITCHES
ON-LOAD CHANGEOVER SWITCHES 4 POLE**

HSN Code: 8536

Rated Current	IN OPEN EXECUTION		IN SHEET STEEL ENCLOSURE	
	Cat Ref.	Unit Price (₹)	Cat Ref.	Unit Price (₹)
63A	ITAE0063	5354	ITAS0063	8232
100A	ITAE0100	7106	ITAS0100	10458
125A	ICAE0125	10648	ICAS0125	15668
160A	ICAE0160	11710	ICAS0160	17232
200A	ICAE0200	14080	ICAS0200	20068
250A	ICAE0250	20158	ICAS0250	26680
320A	ICAE0320	21346	ICAS0320	28760
400A	ICAE0400	30978	ICAS0400	47754
630A	ICAE0630	36494	ICAS0630	51172
800A	ITAE0800	50894	ITAS0800	74966
1000A	ITAE1000	92066	ITAS1000	125642
1250A	ITAE1250	123560	ITAS1250	173456
1600A	ITAE1600	141878	ITAS1600	230154
2000A	ITAE2000	217848	ITAS2000	301958
2500A	ITAE2500	299712	ITAS2500	400528
3150A	ITAE3150	306537	ITAS3150	519950

HSN Code: 8536

ACCESSORIES FOR AMBIDEX CHANGEOVER SWITCHES	Cat Ref.	Unit Price (₹)
Auxiliary Switch 200A-630A (1NO + 1NC)	ICA00AUX	210
Spreader Links for Frame00 - 1 set (4 links)	ICA00SPL	350

ON-LOAD SWITCH FUSE CHANGEOVER

HSN Code: 8536

Rated Current	IN OPEN EXECUTION		IN SHEET STEEL ENCLOSURE		Recommended HRC Fuse Indo Asian Make
	Cat Ref.	Unit Price (₹)	Cat Ref.	Unit Price (₹)	
125A	ITBE0125	15242	ITBS0125	23294	FSDCP
200A	ITBE0200	27848	ITBS0200	41346	FSF
250A	ITBE0250	28110	ITBS0250	41730	FSK
320A	ITBE0320	29022	ITBS0320	43088	FSK
400A	ITBE0400	41628	ITBS0400	61802	FTS
630A	ITBE0630	79064	ITBS0630	72132	FTS

Price does not include HRC Fuses.

HSN Code: 8536

ON-LOAD BY-PASS SWITCHES

Rated Current	IN OPEN EXECUTION		IN SHEET STEEL ENCLOSURE	
	Cat Ref.	Unit Price (₹)	Cat Ref.	Unit Price (₹)
125A	ITCE0125	19972	ITCS0125	26966
200A	ITCE0200	25432	ITCS0200	34332
250A	ITCE0250	36944	ITCS0250	49874
320A	ITCE0320	38360	ITCS0320	51788
400A	ITCE0400	57540	ITCS0400	77682
630A	ITCE0630	65372	ITCS0630	88256

REWIRABLE SWITCH FUSE UNIT

HSN Code: 8537

 <ul style="list-style-type: none"> • Single Pole & Neutral/Double Pole 240/415 VAC 50 Hz • Conforms to IS/IEC 13947-3 	Rating	Type	Cat Ref.	Rated Voltage	Unit Price* (₹)
	16A	SPN	RCSPN016	240 V	762
	32A	SPN	RCSPN032	240 V	1836
	16A	DP	RCDP0016	240 V	804
	32A	DP	RCDP0032	240 V	1886
	32A	DP	#DDP0032	415 V	2574
	63A	DP	#DDP0063	415 V	5130

For Rewirable type carrier, prefix R, for HRC type carrier, prefix H.
* These prices are without wire & HRC.

COMBINATION FUSE SWITCH

HSN Code: 8536

 <ul style="list-style-type: none"> • Double Break in Sheet steel enclosure • Conforms to IS/IEC 13947-3 • Rated Voltage - 415V AC 50 Hz • Type - TPN 	Rating	HRC Fuse Type	Cat Ref.	Unit Price* (₹)
	63A	FSS	DDTPN063	9210
	100A	FSDCP	DDTPN100	12366
	200A	FSF	DDTPN200	18408
	300A	FSK	DDTPN300	23222
	400A	FTS	DDTPN400	33686

* These prices are without HRC.

**TRIPLE POLE NEUTRAL HRC TYPE
REWIRABLE SWITCH FUSE UNIT**

**HSN Code: 8537 H
HSN Code: 8536 R**

 <ul style="list-style-type: none"> • Rated Voltage - 415V-AC 50Hz • Type - TPN 	Rating	HRC Fuse Type	Cat Ref.	Unit Price* (₹)
	16A	FSA	#DTPN016	2222
	32A	FSA	#DTPN032	2990
	63A	FSS	#DTPN063	6364
	100A	FSDCP	#DTPN100	11610

For Rewirable type carrier, prefix R, for HRC type carrier, prefix H.
* These prices are without wire & HRC.

OFF LOAD CHANGEOVER SWITCH

HSN Code: 8536

 <ul style="list-style-type: none"> • With enclosure • Rated Voltage - 415V-AC 50Hz • Type - FP 	Rating	Cat Ref.	Unit Price (₹)
	32A (DP)	OFFDP0032	1810
	16A	OFFP0016	2898
	32A	OFFP0032	3024
	63A	OFFP0063	6146
	100A	OFFP0100	12014
	125A	OFFP0125	16888
	200A	OFFP0200	18232
	250A	OFFP0250	23226
	315A	OFFP0315	23978
	400A	OFFP0400	27972

Prices for spares of Rewirable Switch Fuse Unit like Action Bar, Base Plate, End Shield, Bakelite Contact Shrouds are available on request.

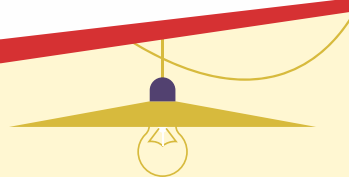
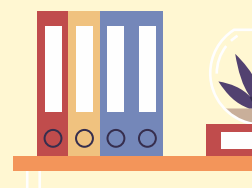

INTRODUCING GLINT WITH USB 1 & 2 MODULE



Glint with USB
1 & 2 Module



Comes with both
wooden & metal screws



Range from
1M to 18M

Glint™
Welcome Change

Glint™ SWITCH / SWITCH WITH INDICATOR

• Polycarbonate Material • LED Indicator • ISI Marked

HSN Code: 8536

Description	Module	Pack	Cat. Nos.	Unit Price (₹)	
				Module	Pack
6A 1-way Switch	1	1/20/400	800000		28
6A 2-way Switch	1	1/20/200	800001		60
16A 1-way Switch	1	1/20/200	800002		84
16A 2-way Switch	1	1/10/100	800003		104
16A 1-way Switch with Indicator	1	1/10/100	800004		102
20A DP Switch	2	1/10/50	800005		124
32A DP Switch	2	1/10/50	800006		186
6A Bell Push with Indicator-1M	1	1/10/100	800007		72
6A Bell Push with Indicator-2M	2	1/10/100	800008		110

Glint™ SOCKET / TELEPHONE SOCKET / COMPUTER SOCKET / TV SOCKET

HSN Code: 8536

• Pencil Free Operation • Child Safety Shutter • Accommodate Wide Range of 2 Pin Round and Flat Pin Plugs • *ISI mark

Description	Module	Pack	Cat. Nos.	Unit Price (₹)	
				Module	Pack
6A 3 Pin Universal Socket	2	1/20/200	800020		64
10A Euro US Socket	1	1/20/100	800021		56
6/16A 3 Pin Socket*	2	1/10/100	800022		120
6A 3 Pin Socket*	2	1/10/100	801800		Coming soon
Multistandard Socket 6/10/13A-250V, 15A-127V	2	1/10/100	800023		114
Telephone Socket - RJ11	1	1/20/100	800030		66
Computer Socket- RJ45	1	1/20/100	800031		154
TV Socket	1	1/20/100	800032		60

Glint™ USB CHARGER

Modular charging socket to charge your Mobile , Tested as per IS standard

HSN Code: 8536

Description	Module	Pack	Cat. Nos.	Unit Price (₹)	
				Module	Pack
USB Charger	2	5/50	800019		900
USB Charger 1.5A	1	10/100	800044		674

Glint™ BUZZER / POWER UNIT / INDICATOR

HSN Code: 8536

• Power Unit - Prewired, Suitable for 2 Ton Ac / 3.5 kw Geyser

Description	Module	Pack	Cat. Nos.	Unit Price (₹)	
				Module	Pack
Buzzer - 230V	1	1/20/100	800040		166
16A Power Unit for AC & Geyser	4	1/1/5	800025		290
Flat Indicator Red	1	1/10/100	800033		82

Glint™ FAN STEP REGULATOR

HSN Code: 8414

• Fan Marking for Easy Identification

Description	Module	Pack	Cat. Nos.	Unit Price (₹)	
				Module	Pack
Fan Step Regulator - 100W	1	1/10/100	800041		288
Fan Step Regulator - 100W - 2M	2	1/10/100	800043		322

Glint™ LIGHT DIMMER

HSN Code: 8538

• Marking for Easy Identification

Description	Module	Pack	Cat. Nos.	Unit Price (₹)	
				Module	Pack
Light Dimmer - 400W	1	1/10/100	800042		278

Glint™ MINI MCB

HSN Code: 8536

- Marking for Easy Identification

	Description	Module	Pack	Cat. Nos.	Unit Price (₹)
	MINI MCB SP 16A	1	1/10/100	800010	270
	MINI MCB SP 20A	1	1/10/100	800011	270
	MINI MCB SP 25A	1	1/10/100	800012	270
	MINI MCB SP 32A	1	1/10/100	800013	270

Glint™ BLANK PLATE / SCREW CAPS

HSN Code: 8538

- Spare Screw Caps Available

	Description	Module	Pack	Cat. Nos.	Unit Price (₹)
	1 Module Blank Plate	1	1/20/200	800051	22
	2 Module Blank Plate	2	1/10/100	800052	24
	Screw Caps	-	1/10/100	800059	22*

* One Unit Contains Ten Pieces of Screw Caps

Glint™ MODULAR PLATES - WHITE COLOUR

- Unique Design - Sleek & Curvy • Flame Retardant Material • Compatible with all Standard Size Metal Flush & Plastic Surface Boxes

HSN Code: 8538

	Description	Module	Pack	Cat. Nos.	Unit Price (₹)
	1 Module Plate	1	1/10/100	800061	44
	2 Module Plate	2	1/10/100	800062	44
	3 Module Plate	3	1/10/100	800063	62
	4 Module Plate	4	1/10/100	800064	72
	6 Module Plate	6	1/5/50	800066	88
	8 Module Plate (Vertical)	8	1/5/25	800067	124
	8 Module Plate (Horizontal)	8	1/5/50	800068	116
	12 Module Plate	12	1/5/25	800065	160
	16 Module Plate	16	1/5/25	800069	168
	18 Module Plate	18	1/5/25	800070	202

Glint™ MODULAR DOUBLE PLATES - WHITE COLOUR

- Aesthetic Design • Suitable for Metal Flush & Wooden Boxes
- Comes in both Metal & Wooden Screws

HSN Code: 8538

	Description	Module	Pack	Cat. Nos.	Unit Price (₹)
	Double Plate + Frame 1M	1	1/10/100	800071	78
	Double Plate + Frame 2M	2	1/10/100	800072	78
	Double Plate + Frame 3M	3	1/10/100	800073	98
	Double Plate + Frame 4M	4	1/10/100	800074	122
	Double Plate + Frame 6M	6	1/10/50	800076	152
	Double Plate + Frame 8M (Vertical)	8	1/5/25	800078	220
	Double Plate + Frame 8M (Horizontal)	8	1/10/50	800079	220
	Double Plate + Frame 10M	10	1/5/25	800080	256
	Double Plate + Frame 12M (Vertical)	12	1/5/25	800082	278
	Double Plate + Frame 12M (Horizontal)	12	1/5/25	800084	278
	Double Plate + Frame 16M	16	1/5/25	800086	316
	Double Plate + Frame 18M	18	1/5/25	800088	348

Glint™ METAL FLUSH BOX

• Made of G.I. Sheet • Earth Terminal for Safety

HSN Code: 8538

	Description	Module	Pack	Cat. Nos.	Unit Price (₹)
	Metal Flush Box - 1 / 2 Module	1 / 2	1/0/40	800172	56
	Metal Flush Box - 3 Module	3	1/0/40	800173	76
	Metal Flush Box - 4 Module	4	1/0/40	800174	88
	Metal Flush Box - 6 Module	6	1/0/20	800176	136
	Metal Flush Box - 8 Module(V)	8	1/0/20	800177	174
	Metal Flush Box - 8 Module(H)	8	1/0/20	800178	174
	Metal Flush Box - 12 Module	12	1/0/10	800175	230
	Metal Flush Box - 16 Module	16	1/0/10	800179	266
	Metal Flush Box - 18 Module	18	1/0/10	800180	284

Glint™ SURFACE BOX

• Flame Retardant Material • Edge to Edge Fitting with Glint Plate

HSN Code: 8538

	Description	Module	Pack	Cat. Nos.	Unit Price (₹)
	Plastic Surface Box 1/2 Module	1 / 2	1/0/50	800182	60
	Plastic Surface Box - 3 Module	3	1/0/35	800183	76
	Plastic Surface Box - 4 Module	4	1/0/25	800184	84
	Plastic Surface Box - 6 Module	6	1/0/10	800186	128
	Plastic Surface Box - 8 Module (V)	8	1/0/15	800187	180
	Plastic Surface Box - 8 Module (H)	8	1/0/10	800188	180
	Plastic Surface Box - 12 Module	12	1/0/10	800185	214
	Plastic Surface Box - 16 Module	16	1/0/10	800189	264
	Plastic Surface Box - 18 Module	18	1/0/10	800190	288

Cover Plates - Glint™

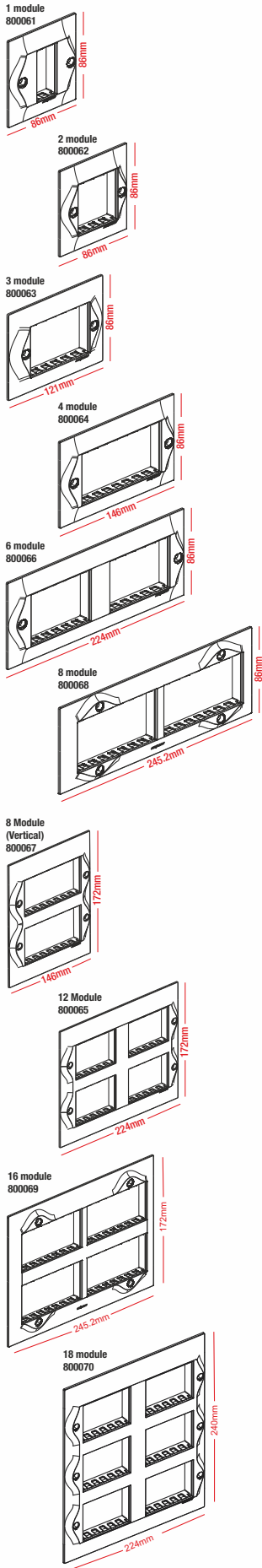

Flush Boxes-Metal

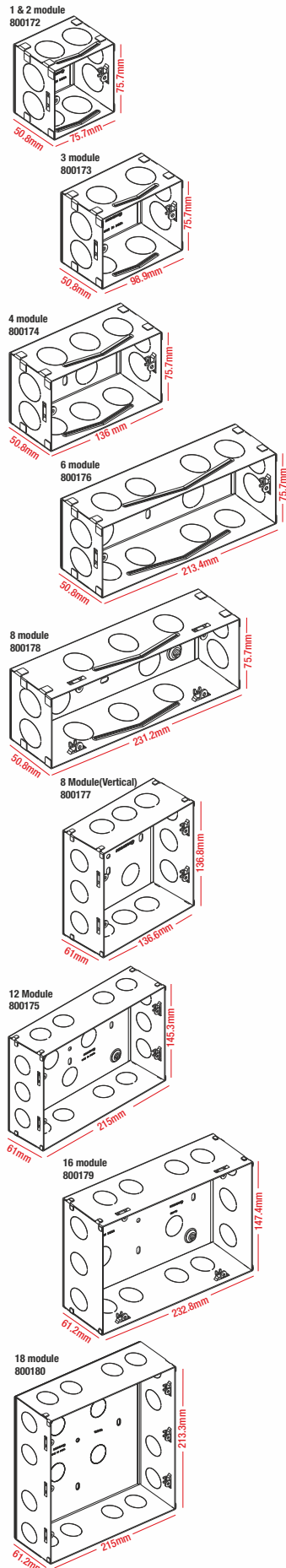

Surface Boxes

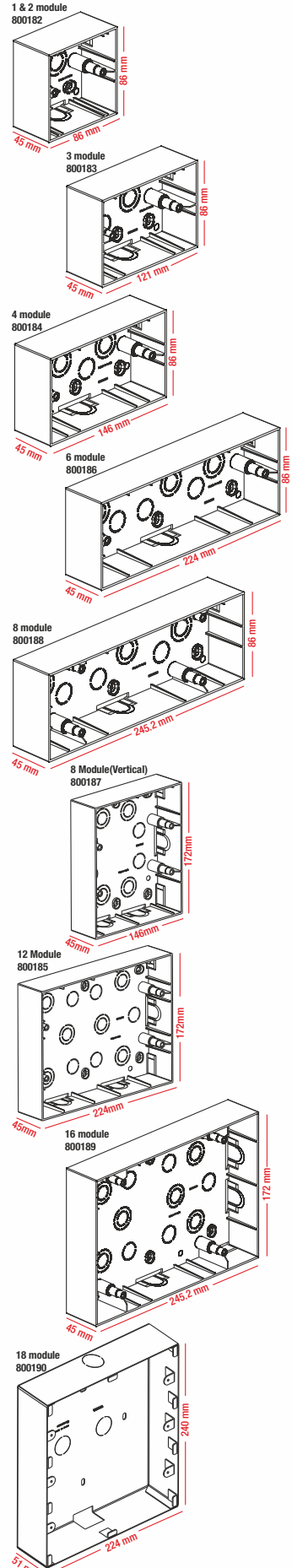



* tested in a controlled environment

#TurnOnYourStyleSense

SHINES EVEN BEFORE SWITCHING ON



Consistent
colour tones



Trending colours



Contemporary
finishes



More resistant to
scratches & Fading*

ELVIRA
A SENSIBLE SWITCH

ELVIRA SWITCH / SWITCH WITH INDICATOR
A SENSIBLE SWITCH

• Polycarbonate Material • LED Based Indicator • Shrouded Terminal • ISI Marked

HSN Code: 8536

Description	Module	Pack	Cat. Nos.	Unit Price (₹)	
				Module	Pack
6A 1 way Switch	1	1/20/400	800100	34	
6A 2 way Switch	1	1/20/100	800101	78	
6A 1 way Switch with Indicator	1	1/20/200	800102	76	
16A 1 way Switch	1	1/20/200	800103	98	
16A 2 way Switch	1	1/10/100	800104	130	
16A 1 way Switch with indicator	1	1/20/200	800105	120	
25A 1 way Switch with indicator	1	1/10/100	800106	172	
20A DP Switch	2	1/10/50	800107	168	
32A DP Switch	2	1/10/50	800108	230	
6A Bell Push with indicator - 1M	1	1/20/200	800110	84	
6A Bell Push with indicator - 2M	2	1/10/100	800111	130	

ELVIRA SOCKET
A SENSIBLE SWITCH

• Child Safety Shutter • Shrouded Terminals • Compatible with all standard Mobile chargers • *ISI mark

HSN Code: 8536

Description	Module	Pack	Cat. Nos.	Unit Price (₹)	
				Module	Pack
6A 3 Pin Universal Socket	2	1/20/200	800120	88	
10A Euro US Socket	1	1/20/100	800121	72	
6/16A 3 Pin Socket*	2	1/10/50	800122	156	
6A 3 Pin Socket*	2	1/10/50	802800	Coming soon	
25A 3 Pin Socket	2	1/10/50	800124	180	
Multistandard Socket 6/10/13A-250v	2	1/10/100	800123	152	

ELVIRA USB CHARGER
A SENSIBLE SWITCH

Modular charging socket to charge your Mobile , Tested as per IS standard

HSN Code: 8536

Description	Module	Pack	Cat. Nos.	Unit Price (₹)	
				Module	Pack
USB Charger	1	10/100	800112	626	
USB Charger 1.5A	1	10/100	800145	762	
USB Charger	2	5/50	800113	1136	

ELVIRA RJ11 / RJ45 / TV SOCKET
A SENSIBLE SWITCH

Tool less, Twisted operation Computer Socket/RJ45

HSN Code: 8536

Description	Module	Pack	Cat. Nos.	Unit Price (₹)	
				Module	Pack
Telephone Socket - RJ11	1	1/20/100	800130	84	
Computer Socket - RJ45 Cat 6	1	1/20/100	800131	220	
TV Socket	1	1/20/100	800132	82	

ELVIRA FAN REGULATOR
A SENSIBLE SWITCH

• Laser marking • ISI mark

HSN Code: 8414

Description	Module	Pack	Cat. Nos.	Unit Price (₹)	
				Module	Pack
Fan Step Regulator 100W - 1M	1	1/10/100	800141	316	
Fan Step Regulator 100W - 2M	2	1/10/100	800142	384	



HOSPITALITY SOLUTION

DND& MMR :

- Make My Room and Do Not Disturb Indicator
- Quality Assurance as per company standards

Key Card :

- Monoblock electronic switch
- Activation switch by card insertion

ELVIRA
A SENSIBLE SWITCH

* tested in a controlled environment

ELVIRA POWER UNIT / CONTROL PRODUCTS / MINI MCB

• LED Indicator • Pre-Wired Power Unit

HSN Code: 8536

	Description	Module	Pack	Cat. Nos.	Unit Price (₹)
	Buzzer 230V	1	1/20/100	800140	232
	Power Unit with 16A AC & GYSR	3	1/1/5	800125	328
	Power Unit with 20A MCB & PLUG	3	1/1/5	800193	800
	Power Unit with 25A MCB & PLUG	3	1/1/5	800194	864
	Bell Call Indicator	1	1/20/100	800144	504
	Flat Indicator Red	1	1/20/100	800154	98
	Skirting light - 2M	2	1/5/25	800155	360
	25A Motor Starter	2	1/5/25	800196	380
	16A Mini MCB SP C curve	1	1/10/100	800160	340
	20A Mini MCB SP C curve	1	1/10/100	800191	340
	25A Mini MCB SP C curve	1	1/10/100	800156	340
32A Mini MCB SP C curve	1	1/10/100	800157	340	

ELVIRA LIGHT DIMMER

• Laser marking

HSN Code: 8538

	Description	Module	Pack	Cat. Nos.	Unit Price (₹)
	Light Dimmer 400W	1	1/10/100	800143	324

ELVIRA HOTEL FUNCTION (KEY CARD AND DND)

• LED Indicator

HSN Code: 8538

	Description	Module	Pack	Cat. Nos.	Unit Price (₹)
	DND Internal Unit	1	1/10/100	800192	168
	DND External Unit	1	1/10/100	800195	200
	Key Card SW 16A	2	1/10	800197	1950

ELVIRA BLANK PLATES / CABLE OUTLET

• Polycarbonate Material

HSN Code: 8538

	Description	Module	Pack	Cat. Nos.	Unit Price (₹)
	1 module Blank	1	1/20/200	800151	26
	2 module Blank	2	1/10/100	800152	42
	Cable outlet	1	1/20/100	800153	70

ELVIRA MODULAR PLATE WITH SUPPORT FRAME - WHITE

• Strong Dimensional Stability

HSN Code: 8538

	Description	Module	Pack	Cat. Nos.	Unit Price (₹)
	1 Module Plate	1	1/10/100	800161	64
	2 Module Plate	2	1/10/100	800162	64
	3 Module Plate	3	1/10/100	800163	88
	4 Module Plate	4	1/10/100	800164	94
	6 Module Plate	6	1/5/50	800166	124
	8 Module Plate (Horizontal)	8	1/5/50	800168	166
	8 Module Plate (Vertical)	8	1/5/25	800167	168
	12 Module Plate	12	1/5/25	800165	244
	16 Module Plate	16	1/5/25	800169	276
	18 Module Plate	18	1/5/25	800170	330

ELVIRA MODULAR PLATE WITH SUPPORT FRAME - SILVER LIGHT PURPLE

• Strong Dimensional Stability



HSN Code: 8538

 	Description	Module	Pack	Cat. Nos.	Unit Price (₹)
	Silver Light purple Plate 1M	1	1/10/100	800201	118
	Silver Light purple Plate 2M	2	1/10/100	800202	118
	Silver Light purple Plate 3M	3	1/10/100	800203	148
	Silver Light purple Plate 4M	4	1/10/100	800204	168
	Silver Light purple Plate 6M	6	1/5/50	800205	248
	Silver Light purple Plate 8M (Horizontal)	8	1/5/50	800206	264
	Silver Light purple Plate 8M (Vertical)	8	1/5/25	800207	320
	Silver Light purple Plate 12M	12	1/5/25	800208	454
	Silver Light purple Plate 16M	16	1/5/25	800209	620
Silver Light purple Plate 18M	18	1/5/25	800210	644	

ELVIRA MODULAR PLATE WITH SUPPORT FRAME - INOX SILVER

A SENSIBLE SWITCH



HSN Code: 8538

 	Description	Module	Pack	Cat. Nos.	Unit Price (₹)
	Inox Silver Plate 1M	1	1/10/100	800211	118
	Inox Silver Plate 2M	2	1/10/100	800212	118
	Inox Silver Plate 3M	3	1/10/100	800213	148
	Inox Silver Plate 4M	4	1/10/100	800214	168
	Inox Silver Plate 6M	6	1/5/50	800215	248
	Inox Silver Plate 8M (Horizontal)	8	1/5/50	800216	264
	Inox Silver Plate 8M (Vertical)	8	1/5/25	800217	320
	Inox Silver Plate 12M	12	1/5/25	800218	454
	Inox Silver Plate 16M	16	1/5/25	800219	620
Inox Silver Plate 18M	18	1/5/25	800220	644	

ELVIRA MODULAR PLATE WITH SUPPORT FRAME - POLARISED GREY

A SENSIBLE SWITCH



HSN Code: 8538

 	Description	Module	Pack	Cat. Nos.	Unit Price (₹)
	Polarised Grey Plate 1M	1	1/10/100	800221	118
	Polarised Grey Plate 2M	2	1/10/100	800222	118
	Polarised Grey Plate 3M	3	1/10/100	800223	148
	Polarised Grey Plate 4M	4	1/10/100	800224	168
	Polarised Grey Plate 6M	6	1/5/50	800225	248
	Polarised Grey Plate 8M (Horizontal)	8	1/5/50	800226	264
	Polarised Grey Plate 8M (Vertical)	8	1/5/25	800227	320
	Polarised Grey Plate 12M	12	1/5/25	800228	454
	Polarised Grey Plate 16M	16	1/5/25	800229	620
Polarised Grey Plate 18M	18	1/5/25	800230	644	

ELVIRA MODULAR PLATE WITH SUPPORT FRAME - ASH PURPLE

A SENSIBLE SWITCH

HSN Code: 8538

 	Description	Module	Pack	Cat. Nos.	Unit Price (₹)
	Ash Purple Plate 1M	1	1/10/100	800231	118
	Ash Purple Plate 2M	2	1/10/100	800232	118
	Ash Purple Plate 3M	3	1/10/100	800233	148
	Ash Purple Plate 4M	4	1/10/100	800234	168
	Ash Purple Plate 6M	6	1/5/50	800235	248
	Ash Purple Plate 8M (Horizontal)	8	1/5/50	800236	264
	Ash Purple Plate 8M (Vertical)	8	1/5/25	800237	320
	Ash Purple Plate 12M	12	1/5/25	800238	454
	Ash Purple Plate 16M	16	1/5/25	800239	620
Ash Purple Plate 18M	18	1/5/25	800240	644	

ELVIRA METAL FLUSH BOX

A SENSIBLE SWITCH

• Made of G.I. Sheet • Earth Terminal for Safety

HSN Code: 8538

	Description	Module	Pack	Cat. Nos.	Unit Price (₹)
	Metal Flush Box - 1 / 2 Module	1 / 2	1/0/40	800172	56
	Metal Flush Box - 3 Module	3	1/0/40	800173	76
	Metal Flush Box - 4 Module	4	1/0/40	800174	88
	Metal Flush Box - 6 Module	6	1/0/20	800176	136
	Metal Flush Box - 8 Module(V)	8	1/0/20	800177	174
	Metal Flush Box - 8 Module(H)	8	1/0/20	800178	174
	Metal Flush Box - 12 Module	12	1/0/10	800175	230
	Metal Flush Box - 16 Module	16	1/0/10	800179	266
	Metal Flush Box - 18 Module	18	1/0/10	800180	284

ELVIRA SURFACE BOX

A SENSIBLE SWITCH

• Flame Retardant Material • Edge to Edge Fitting with Plate

HSN Code: 8538

	Description	Module	Pack	Cat. Nos.	Unit Price (₹)
	Plastic Surface Box 1/2 Module	1 / 2	1/0/50	800182	60
	Plastic Surface Box - 3 Module	3	1/0/35	800183	76
	Plastic Surface Box - 4 Module	4	1/0/25	800184	84
	Plastic Surface Box - 6 Module	6	1/0/10	800186	128
	Plastic Surface Box - 8 Module (V)	8	1/0/15	800187	180
	Plastic Surface Box - 8 Module (H)	8	1/0/10	800188	180
	Plastic Surface Box - 12 Module	12	1/0/10	800185	214
	Plastic Surface Box - 16 Module	16	1/0/10	800189	264
	Plastic Surface Box - 18 Module	18	1/0/10	800190	288

3 PIN PLUGS WITH EASY GRIP

• White Matte Finish • Tested as per IS 1293

HSN Code: 8536

	Description	Pack	Cat. Nos.	Unit Price (₹)
	6A 3 Pin Plug	1/10/50	698470	74
	16A 3 Pin Plug	1/10/50	698471	106

Cover Plates - ELVIRA
A SENSIBLE SWITCH

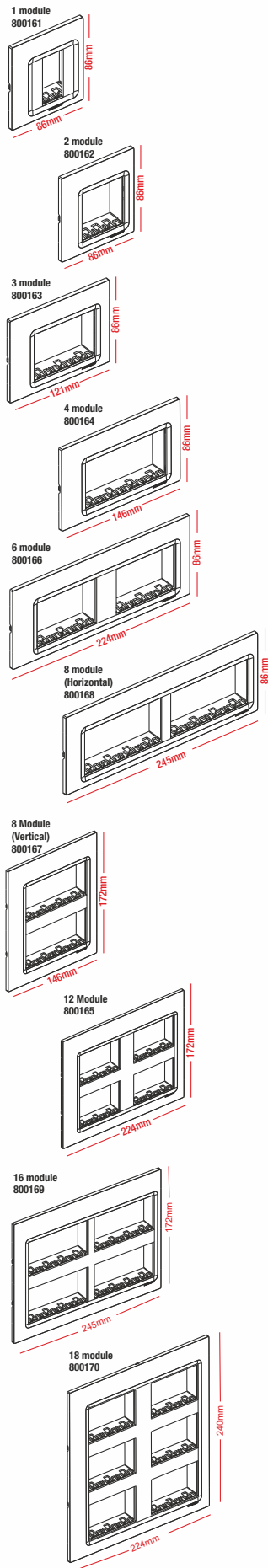

Flush Boxes-Metal

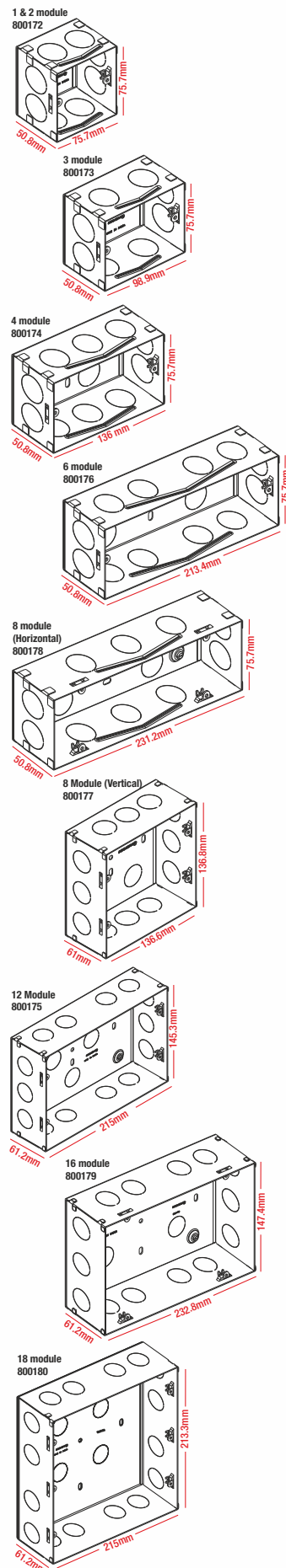

Surface Boxes

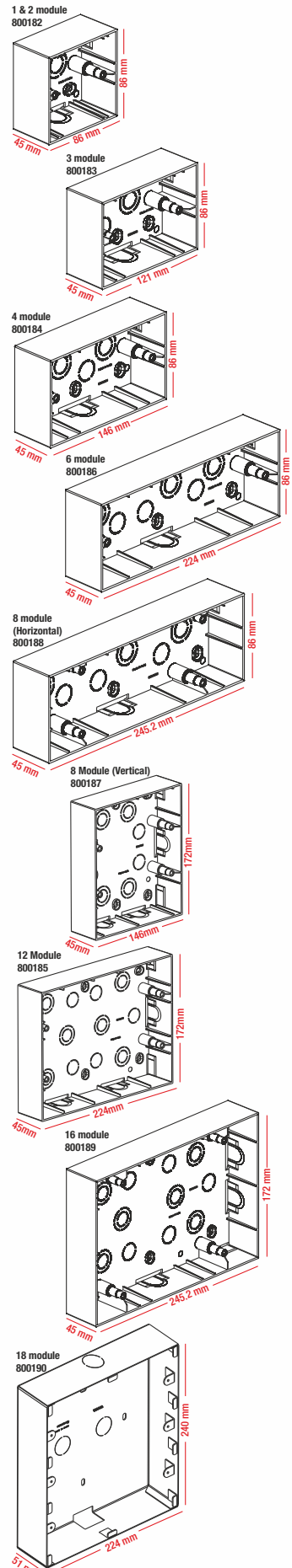

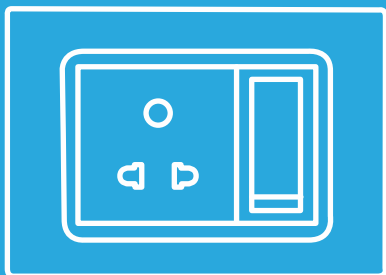

UNIQUE AESTHETIC DESIGN - PLUGS WITH EASY GRIP

Description	HSN Code	Pack	Cat. Nos.	Unit Price(₹)
6A 3 PIN PLUG	8536	1/10/50	698470	74
16A 3 PIN PLUG	8536	1/10/50	698471	106



White Matt
Finish



Tested as per
IS 1293

PLUG

GENERAL TERMS

- This price list supersedes all previous price lists.
- All prices are in Indian Rupees only.
- All prices are Maximum Retail Prices (MRP) inclusive of GST as applicable.
- Our discount structure is exclusive of GST
- Orders will be accepted in multiples of standard packing.
- Prices are subject to change without notice. All despatches will be as per prices prevailing on the date of despatch. Prices are ex-godown, exclusive of packing/forwarding/freight and insurance.
- Product design is subject to change without notice for continuous up gradation.
- Disputes if any are subject to Delhi Jurisdiction only.
- Company reserves the right to issue amendments which may arise due to any printing errors in the price list.

WARRANTY

IA products carry a warranty against manufacturing defects, subject to use of the product for the right application, with correct wiring/connection and normal operating conditions. Please refer to detailed IndoAsian warranty policy effective 1st Jan 2016.

MCBs	36 Months
RCCBs	36 Months
DBs/ACCL	12 Months
Rewirable/HRC Fuses	6 Months
MCCBs/BFF/Fuse Bases/Changeover Switchgears/SDF	12 Months
Time Switches	12 Months
For Wiring Devices - Switches & Socket	120 Months
For Wiring Devices - Electronic Products (e.g. Fan Regulator, Dimmer, Buzzer, RJ45, RJ11 & TV Sockets, Bell Indicator, Motor starter, Skirting light)	24 Months

CHANNEL PARTNER

CORPORATE OFFICE: V. J. Business Towers, A-6, 1st Floor, Sector-125, Noida-201301, U.P., India. Ph.: +91-0120-3305111 E-mail: customer.care@indoasian.com, international@indoasian.com Website: www.indoasian.com

CUSTOMER CARE HEAD: Novateur Electrical & Digital Systems Pvt. Ltd., V. J. Business Towers, A-6, 1st Floor, Sector-125, Noida-201301, U.P., India. Ph.: +91-0120-3305100 E-mail: customer.care@indoasian.com

NORTH

**Regional Sales office
DELHI NCR**

V. J. Business Towers
A-6, Ground Floor,
Sector-125, Noida-201303
Ph.: 0120-6858900

**Branch office
CHANDIGARH**

S.C.O.-11, 2nd Floor,
Sector-26, Madhya Marg,
Chandigarh-160002
Ph.: 0172-3934651

**Branch office
JAIPUR**

433, 4th Floor, Ganpati Plaza,
M. I. Road,
Jaipur-302001
Ph.: 0141-4113528

**Branch office
LUCKNOW**

301, 3rd Floor, Chintel House,
Station Road,
Lucknow-226001
Ph.: 0522-4013210

SOUTH

**Regional Sales office
BANGALORE**

787, 1st Floor "Skyline Vista"
15th Cross, 100 Feet Ring Road
J P Nagar 1st Phase
Bangalore-560 078
Tel: 080-46219999

**Branch office
COCHIN**

Door No.65/1317, Syda Building,
2nd Floor, Kaloor-Kadavanthra Road,
Kaloor, Ernakulam District,
Kochi-682017 (Kerala)
Ph.: 0484-4055581-88

**Branch office
COIMBATORE**

Door No. 83,
Dr. Nanjappa Road,
Coimbatore-641018
Ph.: 0422-2302715

**Branch office
CHENNAI**

No.5, 1st Floor, Mahalingapuram Main Road,
Nungambakkam,
Chennai-600034
Ph.: 044-28172096, 28170527

**Branch office
HYDERABAD**

312, 3rd Floor,
Amrutha Estates, Himayath Nagar,
Hyderabad-500029
Ph.: 040-66742425

WEST

**Regional Sales office
MUMBAI**

401 & 408, K.P. Arrum,
Marol Morshi Road, Andheri East,
Mumbai-400059
Ph.: 022-61035800

**Branch office
AHMEDABAD**

102, 1st Floor, Shivalik High Street,
Near Mansi Circle, Vastrapur,
Ahmedabad-380015
Ph.: 079-29701351-53

**Branch office
INDORE**

202, KK Bafna Arcade,
Janjeerwala Square,
Race Course Road,
Indore-452001
Ph.: 0731-4064064

**Branch office
PUNE**

311, Pride Silicon Plaza,
Bhamburda, Shivaji Nagar,
Senapati Bapat Marg,
Pune-411016
Ph.: 8087610722

EAST

**Regional Sales office
KOLKATA**

"Raikva Building" Room No. 8, 2nd Floor,
3A Ram Mohan Garden Lane,
Beliaghata E.M.Bypass, Kolkata-700010
Ph.: 033-66041503

IA/Price List/10-21/7000



WESUPPORT

E-mail: customer.care@indoasian.com

