

Rittal – The System.

Issue 7.1

Faster – better – everywhere.

► Industrial Enclosure Solutions



ENCLOSURES

POWER DISTRIBUTION

CLIMATE CONTROL

IT INFRASTRUCTURE

SOFTWARE & SERVICES



FRIEDHELM LOH GROUP

Rittal – The System.

Faster – better – everywhere.

What if one name provided a solution for every industrial application...

From mining, manufacturing, petrochemical, energy, water, power distribution, automation and building installation.

Rittal presents The System. Every one of Rittal's 10,000 products fits into the modular, flexible and logical structure to give you maximum efficiency, reduced costs, energy saving, and superior quality in one complete solution. The Rittal range includes product designs for hazardous areas, hygienic and stainless steel applications and climate control to ensure your valuable assets are perfectly protected.

Industrial Enclosure Solutions present you with a complete overview of the Rittal Industrial System, find the right protection for your application.



About Us

Founded in 1961, Rittal has grown to become the largest enclosure manufacturer in the world and a leader in competent thermal management of electrical, electronic and IT equipment.

With over 10,000 employees, 13 production sites, 58 subsidiaries and 150 distribution and logistic centres worldwide. Rittal is your local global provider of innovative enclosure technology.

In Australia since 1995, Rittal is a market leader constantly reviewing and enhancing our systems in line with customer feedback to meet and exceed the requirements of our market. With over 10,000 products, Rittal has the largest range of innovative enclosure solutions supplemented by a vast selection of accessories. With immediate availability of products and localised modification centres, your product can be individually adapted to fit any application.

Our Mission is to design and manufacture the most comprehensive solutions encapsulating the highest quality, leading edge technology and innovation. Rittal strives to continually better our service, to meet and exceed the needs and expectations of our market.

CONTENTS

SMALL ENCLOSURES	3
Polycarbonate Enclosures PK	3
Cast Aluminum Enclosures GA	4
Terminal / Junction Box KL	5 - 6
E-Box Enclosures EB	7
COMPACT ENCLOSURES	8
Wall Mounted Enclosures AE	8 - 11
Sloped Roof Enclosures AE	12
Compact System Enclosures CM	13
Wall Mounted Enclosures CS	14
New Basic Enclosures CS	15
Hygienic Design	16 - 17
Fibreglass Enclosures KS	18
Mining Enclosures	19 - 20
HAZARDOUS AREA	21
Hazardous Area Junction Boxes KEL	21 - 22
ENCLOSURE SYSTEMS	23
System Enclosure SE 8	23
Freestanding Bayable Enclosures TS 8	24 - 25
NEMA 4/NEMA 4x Baying Systems TS 8	26
NEMA 4/NEMA 4x System Enclosure SE 8	27
Hygienic Design	28
PC Enclosures	29
Flex-Block base/plinth system	30
CONSOLE SYSTEMS	31
One-piece Consoles TP	31
Top Console Systems TP	32 - 34
19" WALL MOUNT ENCLOSURE	35
19" 3-Part DK	35
SYSTEM CLIMATE CONTROL	36
Enclosure Climate Control SK	36 - 37
Wall Mounted Cooling Units SK	38
Roof Mounted Cooling Units SK	39 - 40
Wall Mounted NEMA 4x	41
Enclosure Heaters SK	42
TopTherm Fan and Filter Units	43 - 44
Roof Mounted Filter Fans	45
Accessories	46
APPENDIX	47
The Three Stage Coating Process	47
Protection Categories	48
Modification Capabilities	49
Rittal Service	50
Tools	51
ENCLOSURE SELECTOR TOOL	52
Compact Enclosure AE Mild Steel	52
Baying Systems TS 8	53

Polycarbonate Enclosures PK

PK enclosures are made from fibreglass reinforced polycarbonate, which ensures excellent insulating properties and a high level of resistance to chemical and mechanical influences.

Ideal for use in applications where dust-proof, water-proof, fully insulated and corrosion-free encapsulation of electrical and electronic components is required.

Features

- Halogen free
- UV rated to UL786C and DIN 53387/1000h
- High impact strength to DIN 53453

Material

- Housing of fibre-glass reinforced polyamide
- Cover either transparent (version .100) or grey (version .000), made from fibreglass
- Reinforced polycarbonate
- Cover screws from polyamide
- Insulating bung from polyethylene
- All-round foamed-in PU seal



Supply includes

- Enclosure with cover
- Cover screws
- Insulating bungs for wall mounting screws

Light Grey and Transparent Lid

Light Grey Lid	Transparent Lid	Width mm	Height mm	Depth mm	Mounting Plate	Hinges	Wall Bracket
9500000		65	65	57	-	9580000	9583000
9502000		94	65	57	-	9580000	9583000
9504000		94	94	57	-	9580000	9583000
9505000		94	94	81	-	9580000	9583000
9506000		110	110	66	-	9580000	9583000
9507000		110	110	90	-	9580000	9583000
9508000		130	94	57	-	9580000	9583000
9509000		130	94	81	-	9580000	9583000
9510000		130	130	75	-	9580000	9583000
9511000		130	130	99	-	9580000	9583000
9512000		180	94	57	-	9580000	9583000
9513000		180	94	81	-	9580000	9583000
9514000	9514100	180	110	90	-	9581000	9583000
9515000	9515100	180	110	111	-	9581000	9583000
9516000	9516100	180	110	165	-	9581000	9583000
9517000	9517100	182	180	90	9548000	9581000	9583000
9518000	9518100	182	180	111	9548000	9581000	9583000
9519000	9519100	182	180	165	9548000	9581000	9583000
9520000	9520100	254	180	90	9549000	9581000	9583000
9521000	9521100	254	180	111	9549000	9581000	9583000
9522000	9522100	254	180	165	9549000	9581000	9583000
9523000	9523100	360	254	111	9550000	9581000	9583000
9524000	9524100	360	254	165	9550000	9581000	9583000



Cast Aluminium Enclosures GA

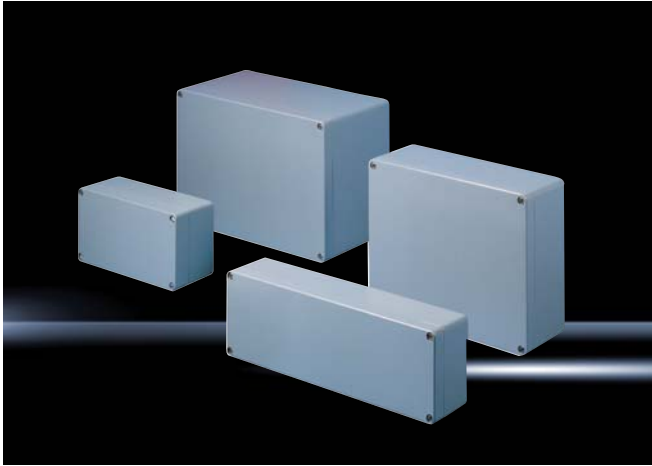

The GA cast aluminium enclosure range provides an alternate material which is extremely robust and able to withstand the harshest industrial environments. The cast aluminium enclosures ensure high chemical and impact resistance and are highly resistant to external impact.

The range comes prepared for mounting internal equipment and rails with drilled and tapped holes. A variety of accessories including hinges and wall brackets compliment the range.

Features

- Good resistance (including seal) to oil, diesel, alcohol and petrol
- Tapped holes for securing DIN rail and mounting plate

Material

- Enclosure: Cast aluminium
- Cover: Cast aluminium, all-round foamed-in PU seal

Supply Includes

- Enclosure with cover
- Cover screws, captive
- Screws for attaching support rails
- Screw for connection of the PE conductor

Model No.	Width mm	Height mm	Depth mm	Mounting Plate	Wall Brackets	Exterior Hinge
9101210	58	64	34	-	-	-
9102210	98	64	35	-	-	-
9104210	75	80	57	-	-	-
9105210	125	80	57	9105700	-	-
9106210	175	80	57	-	-	-
9107210	250	80	57	-	-	-
9108210	122	120	80	9108700	9121122	9123000
9110210	220	120	91	9110700	9121122	9123000
9111210	360	120	82	-	9121122	9123000
9112210	160	160	91	9112700	9121160	9123000
9113210	260	160	91	9113700	9121160	9123000
9114210	360	160	91	9114700	9121160	9123000
9116210	202	232	111	9116700	9121230	9123000
9117210	280	232	111	9117700	9121230	9123000
9118210	330	233	111	9118700	9121230	9123000
9119210	330	230	181	9118700	9121230	9123000



Terminal / Junction Box _{KL}

The KL Terminal Box has been developed and refined through constant customer feedback that has resulted in a terminal box range comprising of 40 different alternatives. Available in mild steel with a powder coated finish as well as stainless steel for corrosive environments.

With a screw fastening lid, integrated mounting rails and a practical depth (80 mm or 120 mm) to suit terminal strips, this enclosure is ideal for any junction or marshalling application. Accessories include mounting plates, support rails, cable gland plates and exterior cover hinges.

Material

- Enclosure: sheet steel
- Sheet steel, all-round foamed-in PU seal

Supply Includes

- Enclosure with cover
- Quick-action screw including plastic bushes
- For enclosures with gland plate plus sheet steel gland
- Plates with seals and assembly parts



Mild Steel

Model No.		With Gland Plate D=120mm	Width mm	Height mm	Mounting Plate	Support Rail (DIN Rail)	
D=80mm	D=120mm					TS 35/7.5	TS 35/15
1514510	1500510	-	150	150	1560700	2314000	-
1528510	1529510	-	200	150	1575700	2315000	-
1516510	1502510	-	200	200	1562700	2315000	-
1515510	1501510	1530510	300	150	1561700	2316000	-
1517510	1503510	1531510	300	200	1563700	2316000	-
-	1507510	1535510	300	300	1567700	2316000	-
-	1589510	-	400	150	1576700	2317000	-
1518510	1504510	1532510	400	200	1564700	2317000	-
-	1508510	1536510	400	300	1568700	2317000	-
-	1511510	1539510	400	400	1571700	2317000	-
-	1505510	1533510	500	200	1565700	-	2318000
-	1509510	1537510	500	300	1569700	-	2318000
1519510	1506510	1534510	600	200	1566700	-	2319000
-	1510510	1538510	600	300	1570700	-	2319000
-	1512510	1540510	600	400	1572700	-	2319000
-	1527510	1542510	800	200	1574700	-	-
-	1513510	1541510	800	400	1573700	-	-



Terminal / Junction Box KL

Stainless Steel 304

Model No.	Width mm	Height mm	Depth mm	Mounting Plate	Support Rail (DIN Rail) TS 35/7.5
1521010	150	150	80	1560700	2314000
1523010	200	200	80	1562700	2315000
1522010	300	150	80	1561700	2316000
1524010	300	200	80	1563700	2316000
1527010	150	150	120	1560700	2314000
1528010	200	200	120	1562700	2315000
1529010	300	200	120	1563700	2316000
1526010	300	300	120	1567700	2316000
1525010	400	200	120	1564700	2317000

Stainless Steel 316L

Model No.	Width mm	Height mm	Depth mm	Mounting Plate	Support Rail (DIN Rail) TS 35/7.5
1521510	150	150	80	1560700	2314000
1523510	200	200	80	1562700	2315000
1522510	300	150	80	1561700	2316000
1524510	300	200	80	1563700	2316000
1525510	400	200	120	1564700	2317000
1526510	300	300	120	1567700	2316000

Accessories

Model No.	Description	Packs Of	
1592000	Cover Hinges	6	
2570100	Earthing Set	5	
1590000	Wall Mounting Bracket (8mm - Zinc)	4	
1594000	Wall Mounting Bracket (8mm - Stainless Steel)	4	
1581000	Plastic Gland Plate (PG 13.5)	5	
1582000	Plastic Gland Plate (PG 13.5/16/21)	5	
2584000	Pole Clamp	1 set	
1199100	Baying Kit	1	
1592010	Cover hinge for KL (316 Stainless Steel)	2	

E-Box Enclosures EB

The EB enclosure series with its shallow depths is designed to support applications where space is limited and offer protection for dense wiring and sensitive small instruments.

The range comes complete with 180° hinges and a universal lock system that can be equipped with a range of lock inserts and handles. The removable mounting plate enables simple components assembly to facilitate compact wiring in the smallest possible space.

Material

- Enclosure: sheet steel
- Door: Sheet steel, all-round foamed-in PU seal

Supply Includes

- Enclosure with hinged door
- 180° hinge
- Cam lock with double-bit insert
- Mounting plate



Mild Steel

Model No.	Width mm	Height mm	Depth mm
1551500	150	150	80
1545500	150	300	80
1546500	200	200	80
1552500	200	300	80
1547500	200	400	80
1553500	150	150	120
1548500	150	300	120
1549500	200	200	120
1554500	200	300	120
1550500	200	400	120
1557500	200	500	120
1555500	300	300	120
1556500	300	400	120
1577500	300	400	155
1578500	300	600	155
1579500	300	800	155

Accessories

Model No.	Description	Packs Of
1590000	Wall Mounting Bracket (8mm - Zinc Plated)	4
2584000	Pole Clamp	1 set
2309000	Mounting Clamp	30
2411610 - 2411670	Polyamide Cable Gland	50



Mild Steel Wall Mounted Enclosures AE



The Rittal range of wall mounted enclosures have been on the market for over 30 years. In this time the manufacturing of these enclosures has been perfected, giving them a quality that cannot be matched. The range has evolved to cater for applications where stainless steel is necessary.

Choose from over 75 variants including powder coated mild steel or stainless steel, single or double door versions, glazed doors and a variety of operating panels. The AE Series is well complemented by a range of accessories that further adapt the enclosures to a given application.



Material:

- Enclosure: Sheet steel
- Door: Sheet steel, all-round foamed-in PU seal

Supply includes:

- Enclosure with hinged door(s), of all-round solid construction
- Gland plate(s) in enclosure base
- For single-door enclosures, door hinged on right, may be swapped to left (except with AE 1032.500 and AE 1035.500)
- With cam lock or 3-point lock system & Mounting plate

Mild Steel

Model No.	Width mm	Height mm	Depth mm	Rain Canopy Mild Steel	Rain Canopy Stainless Steel	Inner Door	Door(s)
*1032500	200	300	120	-	-	XAU10350199	1
*1035500	200	300	155	-	2470000	XAU10350199	1
1036500	300	300	155	-	-	XAU10330199	1
1033500	300	300	210	-	2361000	XAU10330199	1
1034500	300	400	210	-	2361000	XAU10340199	1
1030500	380	300	155	-	2471000	XAU10310199	1
1031500	380	300	210	2501500	2472000	XAU10310199	1
1380500	380	380	210	2501500	2472000	XAU13800199	1
1038500	380	600	210	2501500	2472000	XAU10380199	1
1338500	380	600	350	-	-	XAU10380199	1
1045500	400	500	210	-	-	XAU10450199	1
1037500	400	800	300	-	-	ON REQUEST	1
1050500	500	500	210	-	2362000	XAU10500199	1
1350500	500	500	300	-	-	XAU10500199	1
1057500	500	700	250	-	-	XAU10570199	1
1039500	600	380	210	2502500	2473000	XAU10390199	1
1339500	600	380	350	2511500	-	XAU10390199	1
1060500	600	600	210	2502500	2473000	XAU10600199	1
1054500	600	600	250	-	-	XAU10600199	1
1360500	600	600	350	2511500	-	XAU10600199	1
1076500	600	760	210	2502500	2473000	XAU10760199	1
1376500	600	760	350	2511500	-	XAU10760199	1
1058500	600	800	250	-	-	XAU10580199	1
1090500	600	1000	250	-	-	XAU10900199	1
1260500	600	1200	300	-	-	XAU12600199	1

***IP55 Rating**

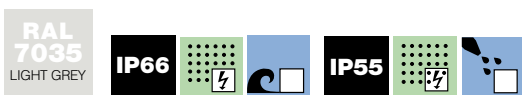

Double Door Enclosures

Mild Steel Wall Mounted Enclosures AE

Model No.	Width mm	Height mm	Depth mm	Rain Canopy Mild Steel	Rain Canopy Stainless Steel	Inner Door	Door(s)
1077500	760	760	210	-	-	XAU10770199	1
1073500	760	760	300	-	2474000	XAU10770199	1
1055500	800	600	300	-	2475000	ON REQUEST	1
1180500	800	1000	300	-	2475000	XAU11800199	1
1280500	800	1200	300	-	2475000	XAU12800199	1
*1100500	1000	760	210	-	-	ON REQUEST	2
*1130500	1000	760	300	-	2363000	ON REQUEST	2
*1110500	1000	1000	300	-	2363000	ON REQUEST	2
*1213500	1000	1200	300	-	2363000	ON REQUEST	2
*1114500	1000	1400	300	-	2363000	ON REQUEST	2
X15 Orange							
XAU1033500OR	300	300	210	-	2361000	XAU10330199	1
XAU1380500OR	380	380	210	-	2472000	XAU13800199	1
XAU1045500OR	400	500	210	-	-	XAU10450199	1
XAU1038500OR	380	600	210	-	2472000	XAU10380199	1
XAU1050500OR	500	500	210	-	2362000	XAU10500199	1
XAU1060500OR	600	600	210	-	2473000	XAU10600199	1
XAU1057500OR	500	700	250	-	-	XAU10570199	1
XAU1058500OR	600	800	250	-	-	XAU10580199	1
XAU1076500OR	600	760	210	-	2473000	XAU10760199	1
XAU1073500OR	760	760	300	-	2474000	XAU10770199	1
XAU1090500OR	600	1000	250	-	-	XAU10900199	1
XAU1180500OR	800	1000	300	-	2475000	XAU11800199	1
XAU1280500OR	800	1200	300	-	2475000	XAU12800199	1

Inner doors available ex stock



*IP55 Rating

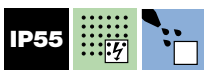

Double Door Enclosures

Stainless Steel Wall Mounted Enclosures ^{AE}

Material

- Enclosure: Stainless Steel
- Door: Stainless steel, all-round foamed-in PU seal
- Mounting plate: Sheet steel
- Locks: Die-cast zinc, 316 s/st enclosures supplied with 316 s/st lock

Supply Includes

- Enclosure with door(s)
- Cam lock or 3-point lock system (for AE 1017.X00 and AE 1019.X00) with double-bit insert
- Mounting plate

Stainless Steel 304

Model No.	Width mm	Height mm	Depth mm	Rain Canopy Stainless Steel	Inner Door	Door(s)
1001600	200	300	120	-	XAU10350199	1
1002600	200	300	155	2470000	XAU10350199	1
1003600	300	300	210	2361000	XAU10330199	1
1005600	300	380	210	2361000	ON REQUEST	1
1004600	380	300	155	2471000	XAU10310199	1
1011600	380	300	210	2472000	XAU10310199	1
1006600	380	380	210	2472000	XAU13800199	1
1008600	380	600	210	2472000	XAU10380199	1
1015600	400	500	210	-	XAU10450199	1
1007600	500	500	210	2362000	XAU10500199	1
1013600	500	500	300	-	XAU10500199	1
1009600	600	380	210	2473000	XAU10390199	1
1010600	600	600	210	2473000	XAU10600199	1
1012600	600	760	210	2473000	XAU10760199	1
1014600	760	760	300	2474000	XAU10770199	1
1016600	800	1000	300	2475000	XAU11800199	1
1017600	800	1200	300	2475000	XAU12800199	1
1018600	1000	1000	300	2363000	ON REQUEST	2
1019600	1000	1200	300	2363000	ON REQUEST	2
XAU1068600	600	800	300	-	XAU10580199	1

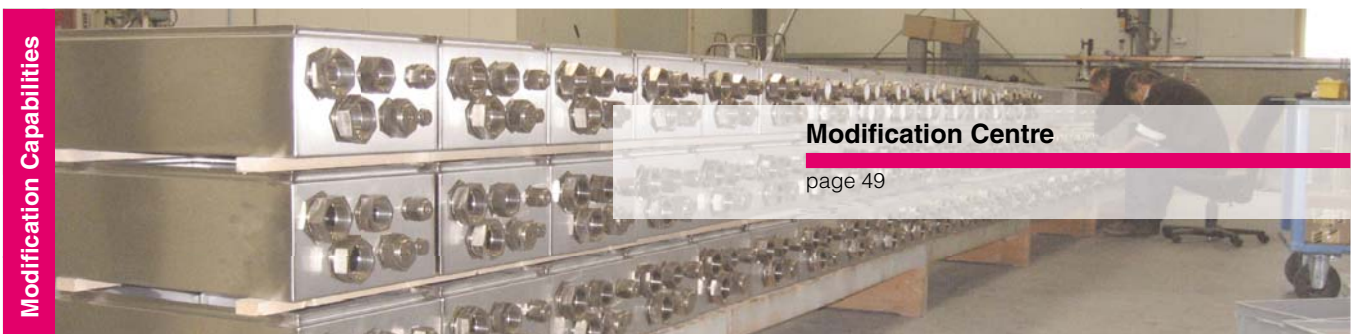

Wall Mounted Enclosures AE

Material

- Enclosure: Stainless Steel 316L
- Door: Stainless steel, all-roundfoamed-in PU seal
- Mounting plate: Sheet steel
- Locks: Die-cast zinc

Surface Finish

- Housing and door: Brushed, grain 240
- Mounting plate: Zinc-plated

Supply Includes

- Enclosure with door(s)
- Cam lock or 3-point lock system (for AE 1017.X00 and AE 1019.X00) with double-bit insert
- Mounting plate

Protection Category

- IP66 for single door enclosure
- IP55 for double door enclosure

Now fitted with Blind Nut in Rear



Padlockable handle for AE SS316L enclosure XAU2535990

Stainless Steel 316L

Model No.	Width mm	Height mm	Depth mm	Inner Door	Door(s)
XAU1001500	200	300	120	XAU10350199	1
XAU1002500	200	300	155	XAU10350199	1
XAU1003500	300	300	210	XAU10330199	1
XAU1005500	300	380	210	ON REQUEST	1
XAU1004500	380	300	155	XAU10310199	1
XAU1011500	380	300	210	XAU10310199	1
XAU1006500	380	380	210	XAU13800199	1
XAU1008500	380	600	210	XAU10380199	1
XAU1015500	400	500	210	XAU10450199	1
XAU1007500	500	500	210	XAU10500199	1
XAU1013500	500	500	300	XAU10500199	1
XAU1009500	600	380	210	XAU10390199	1
XAU1010500	600	600	210	XAU10600199	1
XAU1012500	600	760	210	XAU10760199	1
XAU1014500	760	760	300	XAU10770199	1
XAU1016500	800	1000	300	XAU11800199	1
XAU1017500	800	1200	300	XAU12800199	1
XAU1018500	1000	1000	300	ON REQUEST	2
XAU1019500	1000	1200	300	ON REQUEST	2
XAU1663999	600	600	300	XAU10600199	1
XAU1068500	600	800	300	XAU10580199	1
XAU1684999	600	800	400	XAU10580199	1
XAU1063999	600	1000	300	XAU10900199	1
XAU1884999	800	800	400	ON REQUEST	1
XAU1804999	800	1000	400	XAU12800199	1
XAU1824999	800	1200	400	XAU12800199	1
XAU1024999	1000	1200	400	ON REQUEST	2
XAU1224999	1200	1200	400	ON REQUEST	2

Sloped Roof Enclosures AE

NEW INNOVATION! Specifically designed for coal mining applications, the 30 degree sloped roof protects against dust and moisture.

Features

- 30 degree sloped roof
- 316 grade stainless steel
- Single door
- Optional viewing window available on request
- Fully welded construction
- Additional dust / water proofing provided by rubber seal across top of door
- Door set back underneath canopy
- Blind nutserts fitted for ease of wall mounting
- Additional AE sizes available on request (stainless steel only)

Supply Includes

- Enclosure
- Door with all-round foamed-in PU seal
- Earthing strap
- Wall mounting brackets
- Mounting plate
- 316 stainless steel lock
- Gland plate included s/st

Protection Category

- IP66 Rating to EN 60 529/09.2000



316 Stainless Steel

Model No.	Width mm	Height mm*	Depth mm
XAU1002590	200	300	155
XAU1006590	380	380	210
XAU1008590	380	600	210
XAU1012590	600	760	210
XAU1068590	600	800	300

* Height is usable

Additional sizes available on request



Compact System Enclosures CM

CM (medium size) is the latest addition to the Rittal enclosure range. The available sizes have been carefully decided based on close consultation with equipment manufacturers. This will ensure that the best possible electrical installation, characterised by maximum accessibility and space utilisation, will be achieved with an off the shelf enclosure.

Features

- Equipped with studs for mounting adapter rails to utilise TS interior installation accessories.
- New door handle ensures optimum space utilisation on door for cutouts and door mounted equipment due to its unique lever mechanism.

Material

- Enclosure: Sheet steel, 1.5 mm
- Door: Sheet steel, 2.0 mm, All-round foamed-in PU seal
- Mounting plate: Sheet steel, 3.0 mm



Supply includes

- Enclosure with hinged door(s)
- R/H door hinge with single door enclosures, may be swapped to opposite side
- 3-point lock
- Mounting plate
- Open base for individual cable entry

Mild Steel

Model No.	W mm	H mm	D mm	Base/Plinth 100mm		Base/Plinth 200mm		Internal Assembly Rails		Punched Sections*		Door(s)
				Front/Rear	Side	Front/Rear	Side	Vertical	Horizontal	Depth	Width	
5110500	600	800	400	8601600	8601040	8602600	8602040	5001051	5001050	8612140	8612060	1
5111500	600	1000	400	8601600	8601040	8602600	8602040	5001052	5001050	8612140	8612060	1
5112500	600	1200	300	8601600	8601030	8602600	8602030	5001053	5001050	8612130	8612060	1
5113500	600	1200	400	8601600	8601040	8602600	8602040	5001053	5001050	8612140	8612060	1
5114500	800	1000	300	8601800	8601030	8602800	8602030	5001052	5001051	8612130	8612080	1
5115500	800	1000	400	8601800	8601040	8602800	8602040	5001052	5001051	8612140	8612080	1
5116500	800	1200	300	8601800	8601030	8602800	8602030	5001053	5001051	8612130	8612080	1
5117500	800	1200	400	8601800	8601040	8602800	8602040	5001053	5001051	8612140	8612080	1
5118500	1000	1000	300	8601000	8601030	8602000	8602030	5001052	5001052	8612130	8612000	2
5119500	1000	1200	300	8601000	8601030	8602000	8602030	5001053	5001052	8612130	8612000	2
5120500	1000	1200	400	8601000	8601040	8602000	8602040	5001053	5001052	8612140	8612000	2
5121500	1000	1400	300	8601000	8601030	8602000	8602030	5001054	5001052	8612130	8612000	2
5122500	1000	1400	400	8601000	8601040	8602000	8602040	5001054	5001052	8612140	8612000	2
5123500	1200	1200	400	8601200	8601040	8602200	8602040	5001053	5001053	8612140	8612020	2



Wall Mounted Enclosures cs

Outdoor enclosures for wall or pole mounting. Enclosure-within-an-enclosure concept, outer enclosure with cut-out in the bottom and integrated louvres on the rear panel and side panels for ventilation.

Material

- Enclosure: Aluminium AIMg3
- Mounting plate: Sheet steel, zinc-plated

Surface Finish

- Powder-coated
- UV-resistant pure polyester

Protection Category

- IP 55

Supply Includes

- Double-walled outdoor enclosure, fully preconfigured
- Inner enclosure with mounting plate, gland plate and security lock
- Mounting bracket for enclosure internal thermostat or hygrostat
- Outer enclosure with designer cover and security lock 3524 E
- 2 C rails on the rear panel



Double-walled

Model No.	Outer Enclosure			Inner Enclosure				Clearance			Mounting Plate	
	Width mm	Height mm	Depth mm	Width mm	Height mm	Depth mm	Width mm	Height mm	Depth mm	Width mm	Height mm	
9791015	370	522	210	300	400	170	280	380	145	270	380	
9791025	420	560	210	350	440	170	330	420	145	320	410	
9791035	530	700	265	460	565	220	440	545	195	430	535	
9791045	630	780	380	580	580	333	560	560	308	550	550	

Accessories

Model No.	Wall mounting bracket	Pole Clamp	Enclosure Internal Thermostat	Hygrostat
9791015	9762120	2584000	3110000	3118000
9791025	9765120	2584000	3110000	3118000
9791035	9765120	2584000	3110000	3118000
9791045	9765120	2584000	3110000	3118000



New Basic Enclosures cs

Outdoor enclosure with 100 mm transport plinth and rain canopy with projections on all sides.

Energy

- Mounting benefits – Flexible basic enclosure, optionally with doors front and rear, for rapid interior installation and optimum on-site accessibility
- Variable base mounting – Easy to plan, because it is suitable for all site conditions: Concrete base/plinth, base plate, plastic base/plinth

Water industry

- Ideal material – Powder-coated aluminium for a long service life and corrosion resistance, plus fast machining of cut-outs
- Fast interior installation – All-round 25 mm system punchings and an extensive range of system accessories help to reduce assembly time

Telecommunications

- Fully integrated system solutions for mobile communications and broadband network installation reduce planning complexity
- Vandal-resistant – Enclosure solutions up to resistance category RC4

Telematics

Optimum protection against corrosion - Coordinated mix of materials for heavily contaminated roadside environments increases servicing intervals.

Material

- Aluminium AlMg3

Surface finish

- Powder-coated
- UV-resistant pure polyester

Protection category

- IP 55

Supply includes

- Single-walled outdoor enclosure, fully pre-configured:
- Basic enclosure with open base
 - 25 mm system punchings in the roof, base, front and in the enclosure depth
 - Front door(s) with door stay, swing lever handle and semi-cylinder, lock BJ20027
 - Transport plinth with screwfastened trim panels front and rear



Photo shows a configuration example with equipment not included in the scope of supply.

Single-walled and one-door, width 600 and 800mm

Model No.	Width mm	Height mm	Depth mm	Clearance			Rain Canopy			Base/Plinth-Width mm	Overall-Height mm
				Width mm	Height mm	Depth mm	Width mm	Height mm	Depth mm		
9783540	600	800	400	512	712	349	650	55	450	100	955
9783550	600	1200	400	512	1112	349	650	55	450	100	1355
9783530	600	1200	500	512	1112	449	650	55	550	100	1355
9783510	800	800	400	712	712	349	850	55	450	100	955
9783520	800	1200	400	712	1112	349	850	55	450	100	1355
9783610	800	1200	500	712	1112	449	850	55	550	100	1355

Hygienic Design

Rittal's range of Hygienic Design enclosures are designed and engineered to comply with the highest German hygiene certification.

Specifically created for use in food processing Rittal's HD enclosures ensure there is nowhere for micro-organisms to hide, making cleaning easy, reducing the risk of contamination and significantly increasing your productivity.

Material

- Enclosure and cover: Stainless steel 1.4301 (AISI 304), 1.5 mm
- Mounting bracket: Sheet steel, zinc-plated, passivated, 2.0 mm
- Quick-release fasteners: Stainless steel
- Seal: Silicone, compliant with FDA Guideline 21 CFR 177.2600

Surface finish

- Enclosure and cover: Brushed, grain 400, RA< 0.8 µm
- Seal: Blue, dyed (RAL 5010)

Protection category:

- IP 66 to IEC 60 529
- IP 69K to DIN 40 050-9
- Compliant with NEMA 13
- Compliant with NEMA 4X
- Compliant with NEMA 3R

Supply includes:

- Enclosure of all-round solid construction
- Cover
- Mounting bracket (pre-assembled)
- Seal and quick-release locks (supplied loose)

Detailed drawing:

- Available via rittal.com.au

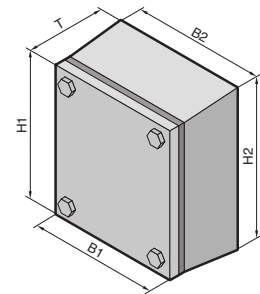
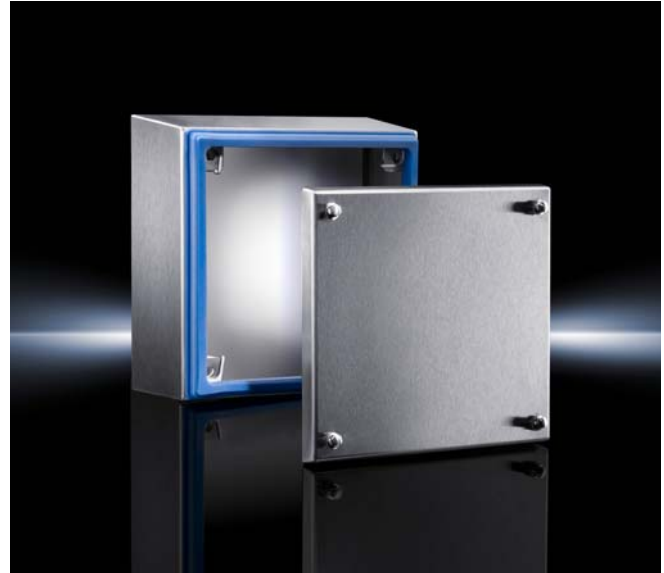

Terminal boxes HD

Model No. HD	Width Front (B1) mm	Width Rear (B2) mm	Height Front (H1) mm	Height Rear (H2) mm	Depth (T) mm	Wall spacer bracket HD	Accessories	Support rail
						Pack of 1	Mounting plate	TS 35/7.5
						Pack of 1	Pack of 1	Pack of 10
1670.600	150	172	150	172	80	4000.100	1560.700	2314.000
1671.600	150	177	150	177	120	4000.100	1560.700	2314.000
1672.600	200	227	200	227	120	4000.100	1562.700	2315.000
1674.600	300	327	200	227	120	4000.100	1563.700	2316.000
1675.600	400	427	200	227	120	4000.100	1564.700	2317.000
1676.600	400	427	300	327	120	4000.100	1568.700	2317.000

Hygienic Design

Material

- Enclosure and door: Stainless steel 1.4301 (AISI 304)
- Mounting plate: Sheet steel
- Lock inserts HD: Stainless steel 1.4404 (AISI 316L)
- Seal: Silicone, compliant with FDA Guideline 21 CFR 177.2600

Surface finish

- Enclosure and door: Brushed, grain 400, $RA < 0.8 \mu m$
- Mounting plate: Zinc-plated
- Seal: Blue, dyed (RAL 5010)

Protection category:

- IP 66 to IEC 60 529
- IP 69K to DIN 40 050-9
Compliant with NEMA 13
Compliant with NEMA 4X

Supply includes:

- Enclosure of all-round solid construction
- Door with press-fitted seal
- Interchangeable door hinge
- Mounting plate

Detailed drawing:

- Available on the Internet.

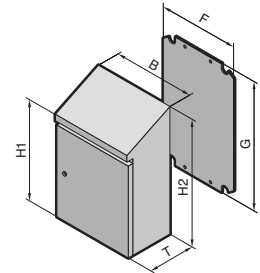

Compact enclosures HD, single-door

Model No. HD	Width Front (B) mm	Height Front (H1) mm	Height Rear (H2) mm	Depth (T) mm	Mounting plate width (F) mm	Mounting plate height (G) mm	Accessories:
							Wall spacer bracket HD
1302.600	220	350	437	155	162	275	Pack of 1 4000.100
1306.600	390	430	549	210	334	355	4000.100
1308.600	390	650	769	210	334	570	4000.100
1307.600	510	550	669	210	449	470	4000.100
1320.600	610	430	601	300	549	355	4000.100
1310.600	610	650	769	210	549	570	4000.100
1316.600	810	1050	1221	300	739	955	4000.100
1317.600	810	1250	1421	300	740	1155	4000.100



Fibreglass Enclosures ks

KS Fibreglass Enclosures are made from lightweight and non-corrosive fibreglass reinforced unsaturated polyester. These fully insulated enclosures are appropriate for outdoor and tough industrial applications. They are available in two versions, with or without viewing windows.

Material

- Enclosure and door: Fibreglass-reinforced unsaturated polyester
- Mounting plate: Sheet steel
- Foamed-in PU seal

Supply Includes

- Enclosure with hinged door, of all-round solid construction, 3 mm double-bit lock
- For single-door enclosures: RH door hinge, may be swapped to opposite side by rotating the enclosure
- For two-door enclosures: Lockable door on right
- Mounting plate
- Twin seal on the top and bottom edges of the door as integral rain protection strip
- Press-fitted C sections at the sides for infinitely variable mounting plate depth adjustment
- KS 1400.500 additionally with removable centre bar in the enclosure



Model No. Standard	Model No. With Window	Width mm	Height mm	Depth mm	Mounting Plate Adjustment	Door(s)
1423500	-	200	300	150	1481000	1
1432500	-	250	350	150	1481000	1
1434500	-	300	400	200	1481000	1
1444500	1448500	400	400	200	1481000	1
1446500	1449500	400	600	200	1481000	1
1453500	1454500	500	500	300	1491000	1
1466500	1467500	600	600	200	1481000	1
1468500	1469500	600	800	300	1491000	1
1480500	1479500	800	1000	300	1491000	1
1400500	-	1000	1000	300	1491000	2

Accessories

Model No.	Description	Packs Of	
1482000	Threaded Inserts M6	20	
2584000	Pole Clamp	1 set	
1483010	Wall Mounting Bracket	4	

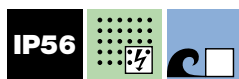

Standard model with viewing window

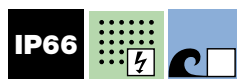

Standard model with no viewing window

Mining Enclosures

Specifically designed for the harsh mining environment, the mining range of field enclosures are able to withstand the most rugged conditions.

Rittal, the world leader in industrial enclosures, advance their German design and engineering expertise to produce a series of sloped roof enclosures for the mining and petrochemical industries.

- IP66 rating
- 2mm thickness
- Maximum door opening
- Optimum mounting area
- 30° sloped roof with generous overhang
- 3 point locking system (available in 700H + sizes)
- Pad lockable
- Foamed in gaskets
- Depth adjustable mounting
- Door stay plate
- Gland plate included



Dimensions and Drawings page 17

Stainless Steel 316 Painted X15 Orange

Model No.	Height mm	Width mm	Depth mm	Handle	Brass Gland Plate	
					3mm	6mm
XAURM4425SSX15	400	400	270	Stainless	RM4425BG3	RM4425BG6
XAURM7522SSX15	700	500	220	Stainless	RM7522BG3	RM7522BG6
XAURM7535SSX15	700	500	370	Stainless	RM7535BG3	RM7535BG6
XAURM10822SSX15	1000	800	220	Stainless	RM10822BG3	RM10822BG6
XAURM10840SSX15	1000	800	420	Stainless	RM10840BG3	RM10840BG6

Stainless Steel 316 Uncoated

Model No.	Height mm	Width mm	Depth mm	Handle		
					3mm	6mm
XAURM4425SS	400	400	270	Stainless	RM4425BG3	RM4425BG6
XAURM7522SS	700	500	220	Stainless	RM7522BG3	RM7522BG6
XAURM7535SS	700	500	370	Stainless	RM7535BG3	RM7535BG6
XAURM10822SS	1000	800	220	Stainless	RM10822BG3	RM10822BG6
XAURM10840SS	1000	800	420	Stainless	RM10840BG3	RM10840BG6

Accessories

Model No.	To Suit Enclosure	Height mm	Width mm
XAURM44HID	RM4425S/SS	375	325
XAURM75HID	RM7522-35S/SS	675	425
XAURM18HID	RM10822-40S/SS	975	725



Mining Enclosure Specifications

H = Overall height at front
H1 = Overall height at rear
H2 = Fixing height
H3 = Opening height

B = Overall width
B1 = Fixing width
B2 = Opening width
B3 = Width of gland plate

T = Overall depth
T1 = Depth of the enclosure
T2 = Maximum mounting depth
T3 = Depth of the enclosure with the door
T4 = Depth of gland plate
T5 = Position of gland plate

Nominal Dimensions HxWxD	Height mm				Width mm				Depth mm					Mounting Plate		
	H	H1	H2	H3	B	B1	B2	B3	T	T1	T2	T3	T4	T5	X	Y
400 x 400 x 270	400	681	641	362	400	300	340	320	270	225	200	245	140	40	325	340
700 x 500 x 220	700	952	912	662	500	400	440	440	220	175	150	195	120	27.5	425	640
700 x 500 x 370	700	1039	999	662	500	400	440	440	370	325	300	345	240	40	425	640
1000 x 800 x 220	1000	1252	1212	962	800	600	740	740	220	175	150	195	120	27.5	725	940
1000 x 800 x 420	1000	1367	1327	962	800	600	740	740	420	375	350	395	210	40	725	940

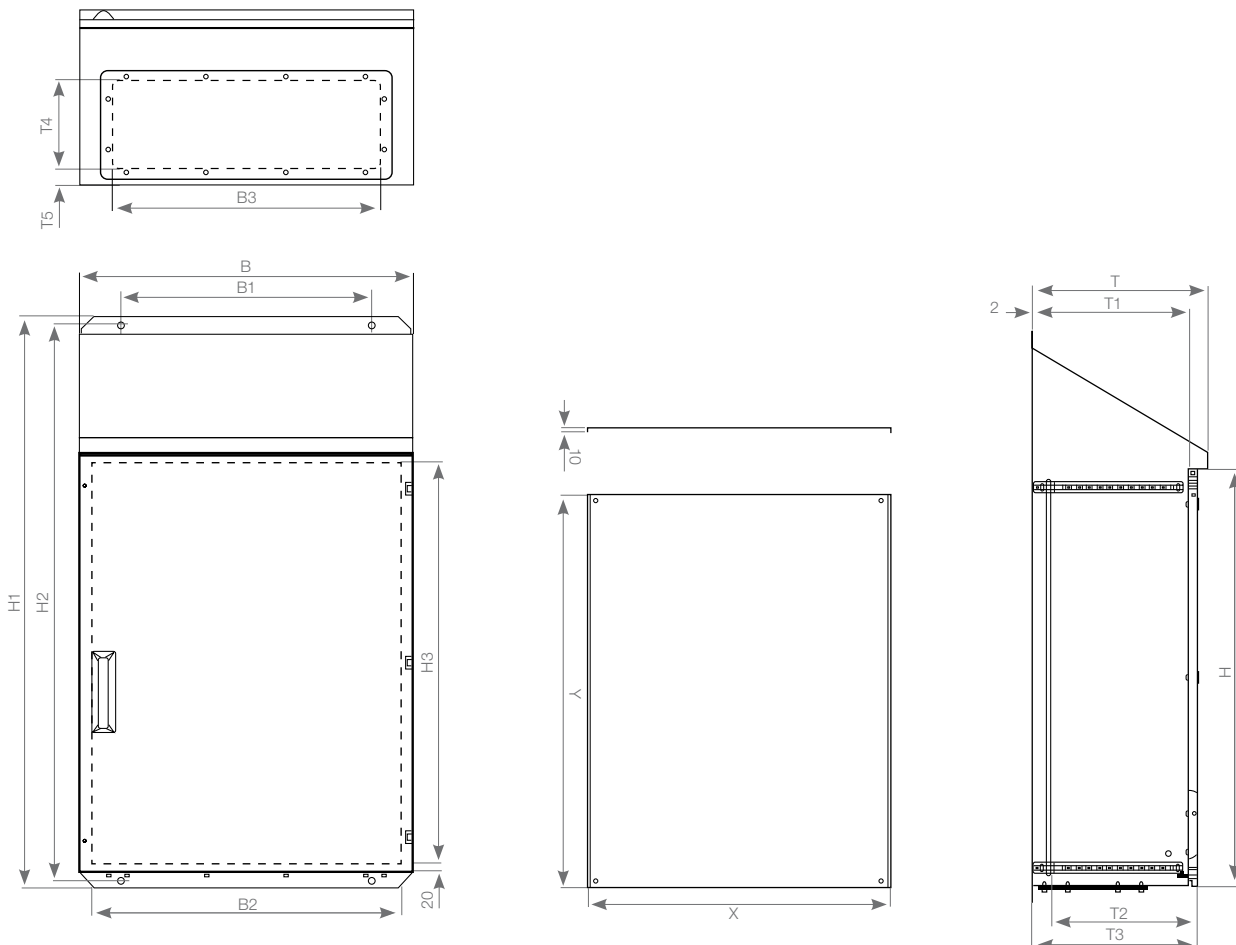

Hazardous Area Junction Boxes KEL

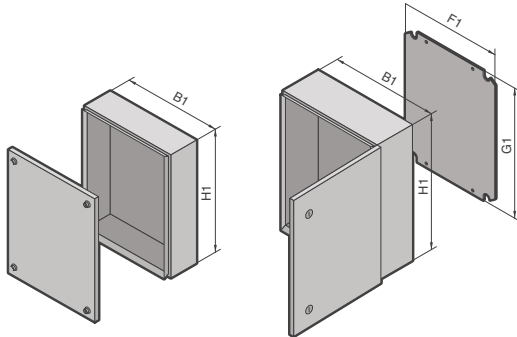

Material

- Stainless Steel 1.4301 (AISI 304)

Surface Finish

- Brushed, grain 240

Protection Category

- IP 66 to EN 60 529/09.2000

Supply Includes

- Enclosure, lid with all-round foamed-in PU seal.

Certificates

- IECEX PTB 09 - 0034

Stainless Steel (screw fastened lid)

Model No.	Width (B1) mm	Height (H1) mm	Depth mm	Mounting Plates
9301000	150	150	80	1560700
9303000	200	200	80	1562700
9302000	300	150	80	1561700
9304000	300	200	80	1563700
9306000	300	300	120	1567700
9305000	400	200	120	1564700

To order Ex enclosures in Stainless Steel 1.4404 (AISI 316L), please add extension .500 to the model No. Delivery times available on request.

Material

- Stainless Steel 1.4301 (AISI 304)

Mounting Plate

- Sheet Steel

Surface Finish

- Brushed, grain 240

Protection Category

- IP 66 EN 60 529/09.2000

Supply Includes

- Enclosure, door with all-round foamed-in PU seal, mounting plate.

Certificates

- IECEX PTB 09 - 0036

Stainless Steel (hinged door)

Model No.	Width (B1) mm	Height (H1) mm	Depth mm	Mounting Plate		Number of Cams
				Width (F1) mm	Height (G1) mm	
9401600	200	300	155	162	275	1
9409600	300	380	210	334	275	1
9402600	380	300	155	334	275	1
9403600	380	380	210	334	355	1
9404600	380	600	210	334	570	2
9405600	600	600	210	549	570	2
9406600	600	760	210	549	730	2
9407600	760	760	300	704	730	2
9408600	800	1000	300	739	955	2

Hazardous Area Junction Boxes KEL

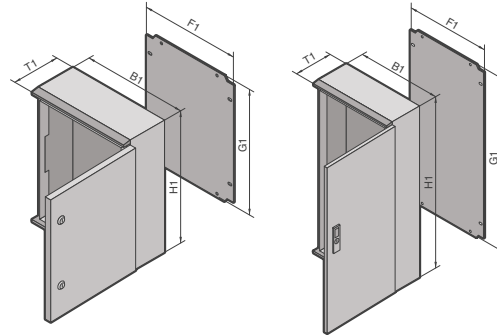

Material

- Enclosure: Fibreglass-reinforced unsaturated polyester
- Surface resistance: $<10^9 \Omega$
- Mounting plate: sheet steel, zinc-plated, passivated

Colour

- RAL 9011

Protection Category

- IP 66 to EN 60 529/09.2000
- KEL 9209.600: IP 56 to EN 60 529/09.2000

Supply Includes

- Enclosure, door with all-round foamed-in PU seal
- Mounting Plate

Certificates

- IECEx PTB 10 - 0011U

Fibreglass-reinforced Unsaturated Polyester

Model No.	Width (B1) mm	Height (H1) mm	Depth mm	Mounting Plate Width (F1) mm	Mounting Plate Height (G1) mm	Number of Cams
9201600	200	300	150	145	250	1
9202600	250	350	150	195	300	1
9203600	300	400	200	245	350	2
9204600	400	400	200	345	350	2
9205600	400	600	200	345	550	2
9207600	500	500	300	417	450	2
9206600	600	600	200	545	550	2
9208600	600	800	300	517	750	*
9209600	800	1000	300	717	950	*

* 3-point lock system

Rittal offer a wide range of customised integrated hazardous area junction box solutions. Solutions are engineered to customer specified requirements in conjunction with international hazardous area standards.

System Enclosure SE 8



Rittal's SE 8 freestanding enclosure system is fully compatible with the TS 8 enclosure system, the platform provides the greatest possible variety of configurations and clear cost advantages in one single solution. The SE 8 platform replaces the ES 5000 enclosure series. TS 8 systems accessories can be used without any restrictions.

Features

- Fully compatible with TS system accessories
- Lower installation costs thanks to integrated profiled sides
- Maximum diversity for cable entry
- Automatic potential equalisation

Material

- Depending on the version: Sheet steel or 1.4301 stainless steel (AISI 304)
- Enclosure: 1.5mm
- Door: 2.0 mm
- Rear panel and gland plates: 1.5mm
- Mounting plate: 3.0mm, sheet steel (for sheet steel and stainless steel enclosures)

Mild steel surface finish:

- Enclosure, door (or double door) and rear panel:
- Dipcoat-primed
 - Externally powder-coated with RAL 7035 textured paint
- Mounting plate and gland plates:
- Zinc-plated

Stainless steel surface finish:

- Enclosure, rear panel, base and door(s):
- Brushed, grain 400
- Mounting plate:
- Zinc-plated

Protection category:

- IP 55 to EN 60 529, complies with NEMA 12

Supply includes:

- Enclosure with door(s)
- With single-door enclosures: Door hinged on the right (can be changed to the left)
- Mounting plate
- Gland plates
- Rear panel (in two pieces from a width of 1600 mm and more), screw-fastened.

Mild Steel

Model No.	Width mm	Height mm	Depth mm	Base/Plinth 100mm		Base/Plinth 200mm		Door(s)
				Front/Rear	Side	Front/Rear	Side	
5830500	600	1800	400	8601600	8601040	8602600	8602040	1
5831500	800	1800	400	8601800	8601040	8601800	8602040	1
5832500	800	2000	400	8601800	8601040	8602800	8602040	1
5833500	800	2000	500	8601800	8601050	8602800	8602050	1
5834500	800	2000	600	8601800	8601060	8602800	8602060	1
5840500	1000	1800	400	8601000	8601040	8602000	8602040	2
5841500	1200	1800	400	8601200	8601040	8602200	8602040	2
5842500	1600	1800	400	8601920	8601040	8602920	8602040	2
5843500	1200	2000	400	8601200	8601040	8602200	8602040	2
5844500	1200	2000	500	8601200	8601050	8602200	8602050	2
5845500	1200	2000	600	8601200	8601060	8602200	8602060	2
5846500	1800	2000	500	8601980	8601050	8602980	8602050	2

304 Stainless Steel

Model No.	Width mm	Height mm	Depth mm	Base/Plinth 100mm		Base/Plinth 200mm		Door(s)
				Front/Rear	Side	Front/Rear	Side	
5850500	600	1600	400	8701600	8701040	8702600	8702040	1
5851500	600	1800	500	8701600	8701050	8702600	8702050	1
5852500	800	1800	500	8701800	8701050	8702800	8702050	1
5853500	800	2000	600	8701800	8701060	8702800	8702060	1
5854500	1000	1800	400	8701000	8701040	8702000	8702040	1
5855500	1200	2000	500	8701200	8701050	8702200	8702050	2



Freestanding Bayable Enclosures TS 8

The TS 8 freestanding enclosure represents an exciting evolution of electrical enclosure systems. Its symmetrical frame allows any number of individual units to be bayed side by side, one in front of the other, and even in a corner at right angles to each other. Once bayed in chosen arrangements, accessibility options are equally flexible. Doors can be installed on any side of the frame ensuring maximum access to the enclosure interior.



Features

- Bayable on all sides
- Universal interior installation
- Mild and Stainless Steel

Material

- Enclosure frame, roof, rear panel and gland plates: Sheet steel, 1.5 mm
- Door: Sheet steel, 2.0 mm
- Mounting plate: Sheet steel, 3.0 mm

Supply includes

- Enclosure frame with door(s), 3 mm double-bit lock insert
- Mounting plate
- Gland plates
- Rear panel
- Roof plate
- 4 eyebolts

Protection category:

- IP 55 to EN 60 529, complies with NEMA 12

Mild Steel

Model No.	Width mm	Height mm	Depth mm	Side Panels	Base/Plinth 100mm		Base/Plinth 200mm		Door(s)
					Front/Rear	Side	Front/Rear	Side	
8615500	600	1200	500	8115235	8601600	8601050	8602600	8602050	1
8645500	600	1400	500	8145235	8601600	8601050	8602600	8602050	1
8665500	600	1600	500	8165235	8601600	8601050	8602600	8602050	1
8684500	600	1800	400	8184235	8601600	8601040	8602600	8602040	1
8685500	600	1800	500	8185235	8601600	8601050	8602600	8602050	1
8686500	600	1800	600	8186235	8601600	8601060	8602600	8602060	1
8604500	600	2000	400	8104235	8601600	8601040	8602600	8602040	1
8605500	600	2000	500	8105235	8601600	8601050	8602600	8602050	1
8606500	600	2000	600	8106235	8601600	8601060	8602600	8602060	1
8608500	600	2000	800	8108235	8601600	8601080	8602600	8602080	1
8626500	600	2200	600	8126235	8601600	8601060	8602600	8602060	1
8815500	800	1200	500	8115235	8601800	8601050	8602800	8602050	1
8845500	800	1400	500	8145235	8601800	8601050	8602800	8602050	1
8865500	800	1600	500	8165235	8601800	8601050	8602800	8602050	1
8884500	800	1800	400	8184235	8601800	8601040	8602800	8602040	1
8885500	800	1800	500	8185235	8601800	8601050	8602800	8602050	1
8880500	800	1800	500	8185235	8601800	8601050	8602800	8602050	2
8886500	800	1800	600	8186235	8601800	8601060	8602800	8602060	1
8881500	800	1800	600	8186235	8601800	8601060	8602800	8602060	2
8804500	800	2000	400	8104235	8601800	8601040	8602800	8602040	1
8805500	800	2000	500	8105235	8601800	8601050	8602800	8602050	1
8806500	800	2000	600	8106235	8601800	8601060	8602800	8602060	1
8808500	800	2000	800	8108235	8601800	8601080	8602800	8602080	1
8826500	800	2200	600	8126235	8601800	8601060	8602800	8602060	1
8828500	800	2200	800	8128235	8601800	8601080	8602800	8602080	1
8084500	1000	1800	400	8184235	8601000	8601040	8602000	8602040	1

* Roller door enclosures available upon request

CAD drawings available from <http://rittal.partcommunity.com/portal/portal/rittal>

Freestanding Bayable Enclosures TS 8

Model No.	Width mm	Height mm	Depth mm	Side Panels	Base/Plinth 100mm		Base/Plinth 200mm		Door(s)
					Front/Rear	Side	Front/Rear	Side	
8080500	1000	1800	400	8184235	8601000	8601040	8602000	8602040	2
8005500	1000	2000	500	8105235	8601000	8601050	8602000	8602050	2
8006500	1000	2000	600	8106235	8601000	8601060	8602000	8602060	2
8215500	1200	1200	500	8115235	8601200	8601050	8602200	8602050	2
8245500	1200	1400	500	8145235	8601200	8601050	8602200	8602050	2
8265500	1200	1600	500	8165235	8601200	8601050	8602200	8602050	2
8284500	1200	1800	400	8184235	8601200	8601040	8602200	8602040	2
8285500	1200	1800	500	8185235	8601200	8601050	8602200	8602050	2
8286500	1200	1800	600	8186235	8601200	8601060	8602200	8602060	2
8204500	1200	2000	400	8104235	8601200	8601040	8602200	8602040	2
8205500	1200	2000	500	8105235	8601200	8601050	8602200	8602050	2
8206500	1200	2000	600	8106235	8601200	8601060	8602200	8602060	2
8208500	1200	2000	800	8108235	8601200	8601080	8602200	8602080	2
8226500	1200	2200	600	8126235	8601200	8601060	8602200	8602060	2
8288500	1200	2200	800	8128235	8601200	8601080	8602200	8602080	2

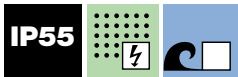

304 Stainless Steel

Model No.	Width mm	Height mm	Depth mm	Side Panels	Base/Plinth 100mm		Base/Plinth 200mm		Door(s)
					Front/Rear	Side	Front/Rear	Side	
8457600	600	1800	500	8700850	8701600	8701050	8702600	8702050	1
8452600	600	2000	600	8700060	8701600	8701060	8702600	8702060	1
8454600	800	1800	400	8700840	8701800	8701040	8702800	8702040	1
8455600	800	1800	500	8700850	8701800	8701050	8702800	8702050	1
8450600	800	2000	600	8700060	8701800	8701060	8702800	8702060	1
8456600	1200	1800	400	8700840	8701200	8701040	8702200	8702040	2
8453600	1200	1800	500	8700850	8701200	8701050	8702200	8702050	2
8451600	1200	2000	600	8700060	8701200	8701060	8702200	8702060	2

* Models available in 316 Stainless Steel
Models available in NEMA 4X

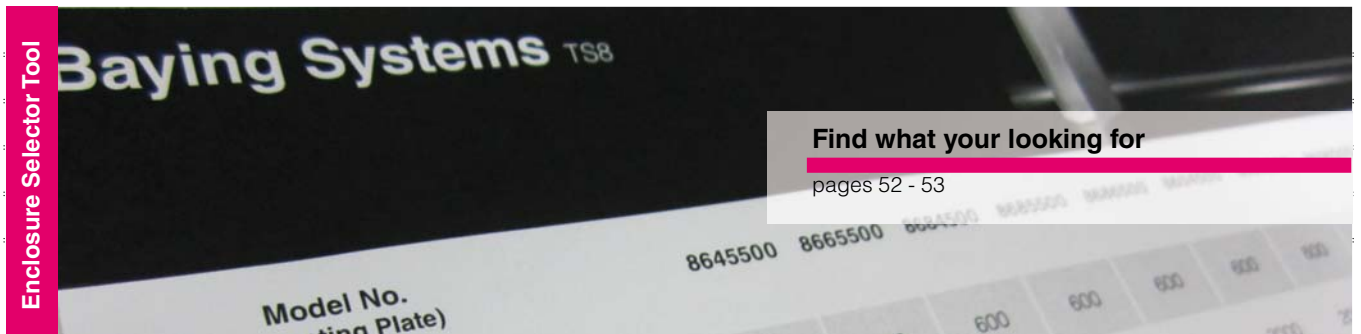

NEMA 4 / NEMA 4x Baying Systems TS 8

Protection Category IP 66

Protection Category

IP 66 to EN 60 529 (complies with NEMA 4x)

Supply Includes

- Enclosure frame with door
- Roof/Base plate
- Rear panel
- Side panels
- Mounting plate

Baying frame required when baying enclosures.

Material

- Mild Steel, spray finished
- Enclosure frame, roof, base/plinth, rear panel, 1.5 mm, door: 2.0 mm
- Mounting plate: 3.0 mm (mild steel)

Surface Finish

- Enclosure frame, door, roof, base, rear panel. Dip coat primed and powder coated in textured RAL 7035 on the outside.
- Mounting Plate: Zinc-plated

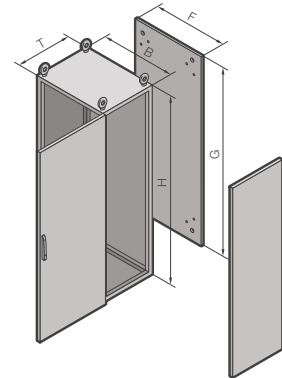

NEMA 4 Mild Steel

Model No.	Width (B1) mm	Height (H1) mm	Depth (T) mm	Mounting Plate		Side Wall	Door(s)
				Width (F1) mm	Height (G1) mm		
8806580	800	2000	600	699	1896	8106235	1

Material

- Stainless Steel 1.4301 (AISI 304)
- Enclosure frame, roof, base/plinth, rear panel, 1.5 mm, door: 2.0 mm.
- Mounting plate: 3.0 mm (mild steel).

Surface Finish

- Enclosure frame: Uncoated
- Door, roof, base, rear panel: Brushed on the outside, grain size 400.
- Mounting Plate: Zinc-plated

NEMA 4X Stainless Steel

Model No.	Width (B1) mm	Height (H1) mm	Depth (T) mm	Mounting Plate		Side Wall	Door(s)
				Width (F1) mm	Height (G1) mm		
8450680	800	2000	600	699	1896	8700060	1

Most standard TS8 sizes available on request



NEMA 4 / NEMA 4x System Enclosure SE 8

Protection Category IP 66



Rittal's SE 8 freestanding enclosure system is fully compatible with the TS 8 enclosure system, the platform provides the greatest possible variety of configurations and clear cost advantages in one single solution. TS 8 system accessories can be used without any restrictions.

Features

- Fully compatible with TS system accessories
- Lower installation costs thanks to integrated profiled sides
- Maximum diversity for cable entry
- Automatic potential equalisation

Material

- Depending on the version: Sheet steel or 1.4301 stainless steel (AISI 304)
- Enclosure: 1.5 mm
- Door: 2.0 mm
- Rear panel and gland plates: 1.5 mm
- Mounting plate: 3.0 mm, sheet steel (for sheet steel and stainless steel enclosures)

Mild steel surface finish:

- Enclosure, door (or double door) and rear panel:
- Dipcoat-primed
 - Externally powder-coated with RAL 7035 textured paint
- Mounting plate and gland plates:
- Zinc-plated

Stainless steel surface finish:

Enclosure, rear panel, base and door(s):

- Brushed, grain 400
- Mounting plate:
- Zinc-plated

Protection category:

- IP 66 to EN 60 529, complies with NEMA 12

Supply includes:

- Enclosure with door(s)
- With single-door enclosures: Door hinged on the right (can be changed to the left)
- Mounting plate
- Gland plates
- Rear panel (in two pieces from a width of 1600 mm and more), screw-fastened

IP 66/NEMA 4 (Mild Steel)

Model No.	Width (B) mm	Height (H) mm	Depth (T) mm	Mounting Plate width (F) mm	Mounting Plate height (G) mm
5830.580	600	1800	400	499	1696
5831.580	800	1800	400	699	1696
5834.580	800	2000	600	699	1896

IP 66/NEMA 4X (304 stainless steel)

Model No.	Width (B) mm	Height (H) mm	Depth (T) mm	Mounting Plate width (F) mm	Mounting Plate height (G) mm
5850.580	600	1600	400	499	1496
5852.580	600	1800	600	699	1696
5853.580	800	2000	600	699	1896

Hygienic Design

Material

- Stainless steel 1.4301(AISI 304)
 - Enclosure: 1.5 mm
 - Door: 2.0 mm
- Lock inserts: Stainless steel
- Seal: Silicone, compliant with FDA Guideline 21 CFR 177.2600
- Mounting plate: Sheet steel

Surface finish

- Brushed, grain 400, RA < 0.8 µm
- Mounting plate: Zinc-plated
- Seal: Blue, dyed (RAL 5010)

Protection category

- IP 66
- IP 59 K

Supply includes:

- Enclosure, closed at rear and bottom, open at top and sides
- Door
- Mounting plate



System Enclosure HD

Model No.	Width mm	Height mm	Depth mm	Accessories				
				HD Side Panels	HD Baying Frame	Mounting Plate Infill	HD Angled Roof 30°	HD Side Panels for Angled Roof
				1 Pair	Pack of 1	Pack of 1	open at the sides Pack of 1	1 PairWW
4000485*	400	1800	500	4000185*	4000785	4000508*	4000545*	4000505*
4000685*	600	1800	500	4000185*	4000785	4000508*	4000565*	4000505*
4000885*	800	1800	500	4000185*	4000785	4000508*	4000585*	4000505*
4000285*	1200	1800	500	4000185*	4000785	4000508*	4000525*	4000505*

*Customised/Extended delivery times

PC Enclosures



Secure accommodation of all PC components, from monitors, to PCs, to keyboards. For ultimate ease of operation in a modern design. Perfect protection from humidity and dirt, temperature fluctuations and unauthorised access.

Material

- Enclosure, door, mounting compartment, supports: Sheet steel
- Handles, decorative trim panels: Plastic
- Door trim panels: Aluminium
- Viewing window: Single-pane safety glass

Surface finish:

- Enclosure and door: Dipcoat-primed, panels, powder-coated on the outside, textured paint.
- Mounting compartment, support: Powder-coated

Colour:

- Enclosure, door, decorative trim panels, supports: RAL 7035
- Handle: Similar to RAL 9006
- Monitor field, central door section: RAL 7015

Protection category IP to IEC 60 529:

- IP 55

Protection category NEMA:

- NEMA 12

Supply includes:

- Enclosure, door, rear door
- Please note the product-specific scope of supply.

Approvals:

- UL
- cUL

Technical details:

Available on www.rital.com.au

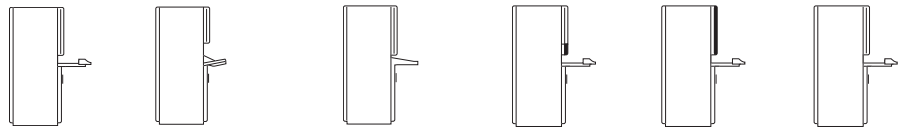

Model No.	5366.000	5366.100	5366.200	5366.300	5366.400	5368.000
Width mm	600	600	600	600	600	600
Height mm	1600	1600	1600	1600	1600	1600
Depth mm	636	636	636	636	636	836
Product-specific scope of supply						
Glazed door, top	■	■	■	■	-	■
Keyboard drawer	■	-	-	■	■	■
Component shelf	■	■	■	■	-	■
Folding keyboard	-	■	-	-	-	-
Desk section	-	-	■	-	-	-
Mounting component, small	-	-	-	■	-	-
Mounting component, large	-	-	-	-	■	-
Max keyboard dimensions (WxHxD)	480x70x260	475x50x250	540x40x175	480x70x260	480x70x260	480x70x260
Accessories						
Base/plinth, stationary	8800.920	8800.920	8800.920	8800.920	8800.920	-
Base/plinth components, front and rear, 100mm	8601.600	8601.600	8601.600	8601.600	8601.600	8601.600
Base/plinth components, front and rear, 200mm	8602.600	8602.600	8602.600	8602.600	8602.600	8602.600
Base/plinth trim panels, side, 100mm	8601.060	8601.060	8601.060	8601.060	8601.060	8601.080
Base/plinth trim panels, side, 200mm	8602.060	8602.060	8602.060	8602.060	8602.060	8602.080
Partial mounting plates	8614.675	8614.675	8614.675	8614.675	8614.675	8614.675
Component shelf, pull-out	6902.960	6902.960	6902.960	6902.960	6902.960	6902.980

Flex-Block base/plinth system

Flex-Block corner pieces

For TS, TS IT, SE, PC, CM, TP

High-strength plastic corner pieces for individual tool-free assembly with Flex-Block trim panels and accessories.

Material

- Corner pieces: Fibreglass-reinforced plastic
- Cover caps: ABS

Colour

- RAL 9005

Supply includes

- 1 set = 4 corner pieces
- 4 cover caps
- Assembly parts for mounting on the enclosure

Model No.	Corner pieces height mm	Packs Of
8100000	100	1
8200000	200	1

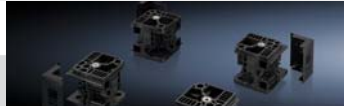

Flex-Block trim panels

For Flex-Block corner pieces

For tool-free assembly. With symmetrical enclosure dimensions, trim panels are identical in the width and depth.

Material

- Trim panels: Sheet steel

Colour

- RAL 9005

Supply includes

- 1 set = 2 trim panels

Model No.	Height mm	For enclosure width and depth in mm
8100300	100mm	300
8100400	100mm	400
8100500	100mm	500
8100600	100mm	600
8100800	100mm	800
8100010	100mm	1000
8100120	100mm	1200
8100160	100mm	1600
8100180	100mm	1800
8200300	200mm	300
8200400	200mm	400
8200500	200mm	500
8200600	200mm	600
8200800	200mm	800
8200010	200mm	1000
8200120	200mm	1200
8100602	100mm, vented	600
8100802	100mm, vented	800



One-Piece Consoles TP

The one piece console TP boasts exceptional functionality in terms of its modular interior installation, assembly friendliness and system accessories. It integrates perfectly into the system platform TS 8, utilising the extensive, assembly friendly range of TS8 system accessories.

Material

- Enclosure: Sheet steel 1.5 mm
- Door and console cover: Sheet steel, 2.0 mm, all-round foamed-in PU seal
- Mounting plate: Sheet steel 3.0 mm
- Lock cover: Plastic, self-extinguishing

Supply Includes



- Enclosure, solid back and sides
- Door or double door at front, with locking rod
- Mounting plate
- Cover hinged at rear, 2 stays with automatic locking and unlocking
- Open base for individual cable entry



Mild Steel

Model No.	Width mm	Height mm	Depth Bottom mm	Depth Top mm	Base/Plinth 100mm		Base/Plinth 200mm		Door(s)
					Front/Rear	Side	Front/Rear	Side	
6746500	600	960	400	520	8601600	8601040	8602600	8602040	1
6748500	800	960	400	520	8601800	8601040	8602800	8602040	1
6748500	1000	960	400	520	8601000	8601040	8602000	8602040	2
6742500	1200	960	400	520	8601200	8601040	8602200	8602040	2

Accessories

Model No.	Description	Pack of	
2889000	Levelling Feet (M12)	4	
2890000	Levelling Feet (M16)	4	
4611000	Twin Castors 40kg (50mm Clearance - No Locks - Black)	1 set	
7495000	Twin Castors 120kg (125mm Clearance - 2 Locks - Black)	1 set	

* Gland plates sold separately



Top Console System TP

Easy selection of your desired combination

The TP TopConsole System components can be combined in many user specific versions as shown in the diagrams below. The table opposite allows you to immediately find the model number for your selection. In addition to this, the IW and Command Panel range make the new TopConsole system TP combination options virtually infinite.

1. Select plinth and pedestal
2. Select centre part, console or trim panel
3. If using centre part, now select a console or trim panel

* Gland plates sold separately



Small operating units are easily integrated into separate Command Panels.



Completely new options with regard to space utilisation are available when used in conjunction with our range of IW enclosures.







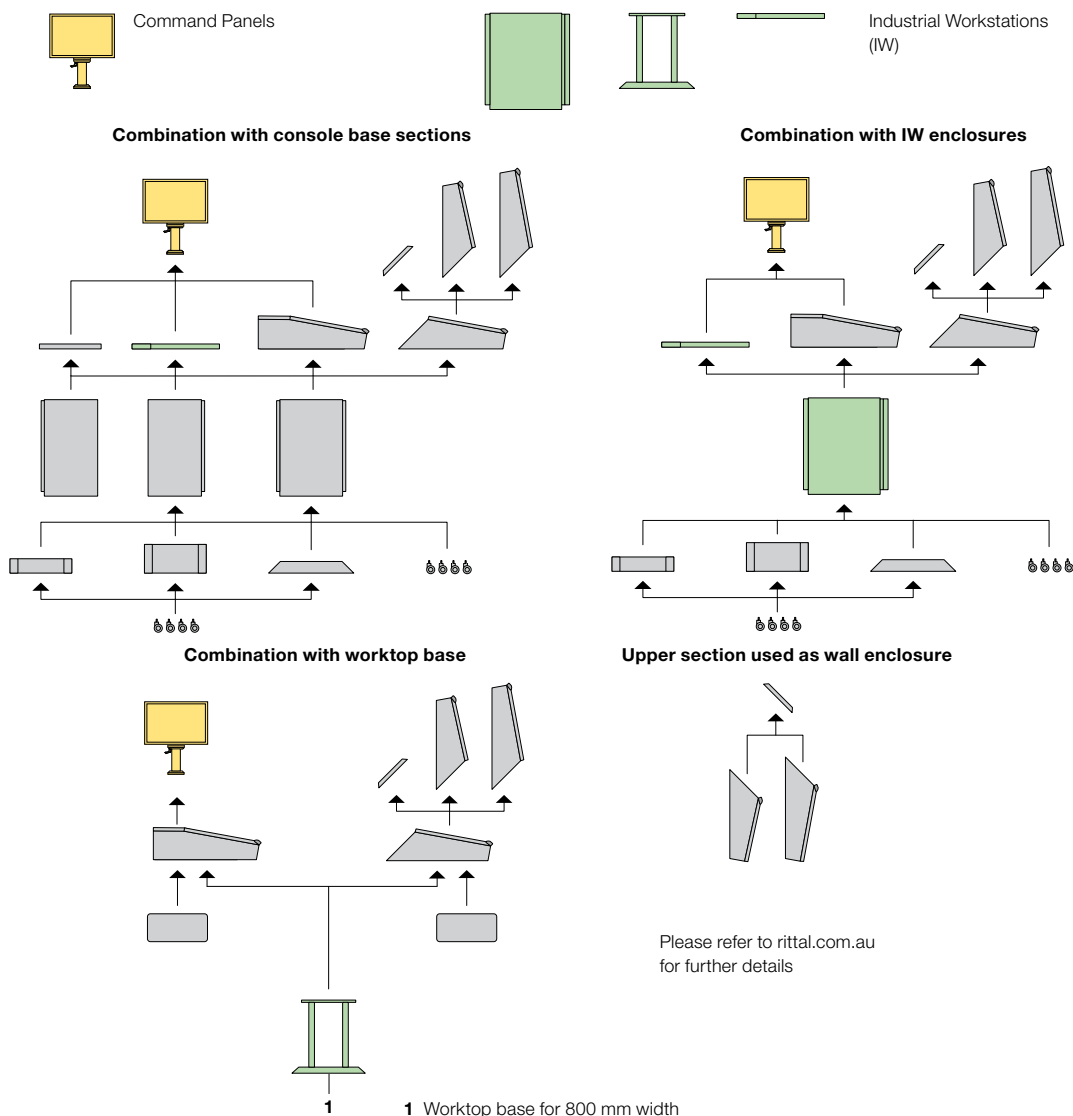



The TS modular base/plinth system also ensures more cable entry flexibility even when using consoles.

Rittal human/machine interface family



Top Console System TP

Overview Table

Width mm		600 Model No.		800 Model No.		1200 Model No.		1600 Model No.	
Console, Upper Section									
	Height 750 mm	6720500		6721500		6722500		6723500	
	Height 650 mm	6724500		6725500		6726500		6727500	
Desk Unit Already Prepared for an Upper Section									
	Depth 755 mm	6714500		6715500		6716500		6717500	
Console/Desk Unit Trim Panel									
	For Height 650/750 mm	6730200		6730210		6730220		6730230	
Rear of Desk Unit, with Hinged Lid									
	Depth 755 mm	6710500		6711500		6712500		6713500	
Gland Plate for Desk Unit									
	Size	4		5		4		5	
	Qty.	1		1		2		2	
Trim Panel									
	D mm	400	500	400	500	400	500	400	500
		6730000	6730100	6730010	6730110	6730020	6730120	6730030	6730130
Pedestal									
	D mm	400	500	400	500	400	500	400	500
	Height 675 mm	6700500	6704500	6701500	6705500	6702500	6706500	6703500	6707500

Top Console System TP

Overview Table

Width mm		600 Model No.	800 Model No.	1200 Model No.	1600 Model No.				
Base/Plinth Components, Front and Rear									
	Height 200 mm	8602600	8602800	8602200	8602920				
	Height 100 mm	8601600	8601800	8601200	8601920				
Base/Plinth Trims, Side									
	D mm	400	500	400	500	400	500	400	500
	Height 200 mm	8602040	8602050	8602040	8602050	8602040	8602050	8602040	8602050
	Height 100 mm	8601040	8601050	8601040	8601050	8601040	8601050	8601040	8601050
Cross Member, Adjustable									
	Height 75 mm	8601450	8601450	8601450	8601450				
Castors									
	Height 125 mm	4634500	4634500	4634500	4634500				

Wall Mount Enclosure 19" 3-Part DK

The three-part wall mount enclosure is ideal as a corridor distributor or for small network applications. Due to the hinged body design, the access to the rear section of the wall box offers a versatile solution. This enclosure has a higher environmental protection rating than standard wall boxes. Individually keyed door and rear sections offer a high level of security to prevent unauthorised access.



Model No.	RU	Width mm	Height mm	Depth mm
7706135	6	600	345	473
7709135	9	600	478	473
7709735	9	600	478	573
7709535	9	600	478	673
7712135	12	600	612	473
7715135	15	600	746	473
7715735	15	600	746	573
7715535	15	600	746	673
7718135	18	600	878	473
7721135	21	600	1012	473
7721735	21	600	1012	573
7721535	21	600	1012	673

Material

- Wall and hinged part: Sheet steel, 1.5 mm
- Viewing window: Single-pane safety glass, 3 mm

Supply Includes

- Wall section
- Hinged part with 25 mm pitch pattern of holes in the front and rear frame
- Designer glazed door
- Mini comfort handle for 3 - 15 U
- Comfort handle and 2-point lock for 18 - 21 U
- Including security lock 3524 E
- Product-specific supply scope

Accessories

Model No.	Description	Pack of	
7705035	Gland Plate (Brush Insert)	1	
2503010	Wall Mounting Bracket (40mm - Zinc Plated)	4	
7113000	Earth Rail (Horizontal) 450mm	1	
7119250	Component Shelf 2U Static (482.6 x 250 - 25kg)	-	
7119140	Component Shelf 1U Static (482.6 x 140 - 10kg)	-	
8611180	Lock Inserts (3524E)	-	
8611200	Lock Inserts (12321)	-	
7980100	Fan Expansion Kit (230V - Air Throughput 108/120m³/h - 50/60Hz)	1 set	
3322700	Spare Filter Mats	5	

* Glazed door frames are RAL7035/7015

Standard wall box with		Pre-configured

Enclosure Climate Control SK

World's First. The Blue e+ cooling units series - The ultimate in efficiency



Rittal is proud to introduce Blue e+, a completely new generation of cooling units – a quantum leap in terms of cost-effectiveness. As well as providing far higher energy efficiency than existing cooling solutions, the units are also distinguished by their flexibility, safety and ease of handling.

Efficiency

- Innovative hybrid technology
 - Two parallel cooling circuits working together, depending on temperature difference
- Speed regulation for demand-based cooling
- The required cooling output in the enclosure is calculated
- Fan and compressor speed are centrally controlled via the inverter
- Protection of components due to constant cold air outlet temperature, no cycling
- The cooling unit adapts flexibly to temperature changes in the enclosure

Versatility

- Multi-voltage capability
- Inverter technology:
 - The cooling units can be used for several voltages without installing a transformer
 - Possible voltages:
 - 110V - 240V; 1~; 50-60Hz
 - 380V - 480 V; 3~; 50-60Hz
 - Standardised installation cut-outs for multiple cooling capacities

Safety

- Higher protection class IP55 (internal circuit)
 - No reduction of the enclosures' protection class
- Operating Temperature range -20°C to 60°C
- High traceability of important parts with separate QR-Codes

User-friendliness

- Multicolor TFT-touch display (industrial grade and multi-lingual)
- Actual operating status and detailed status display
- Quick diagnosis with Smartphone App via NFC
- Remote monitoring via Ethernet and device analysis with RiDiag via USB interface
- Detailed function analysis and parameter setting capabilities via diagnosis software RiDiag



- Temperature control**
- e+ controller (factory setting +35°C)

- Protection category IP to IEC 60 529**
- Internal circuit IP 55

- Material**
- Sheet steel

- Supply includes**
- Assembly parts



Model No.	Width mm	Height mm	Depth mm	Operating Voltage (V) (50/60Hz)	Cooling Output (W)*
3186930	450	1600	294	110 - 240, 1~, 50/60 380 - 480, 3~, 50/60	2000
3187930	450	1600	294	110 - 240, 1~, 50/60 380 - 480, 3~, 50/60	2600
3188940	450	1600	294	380 - 480, 3~, 50/60	4200
3189940	450	1600	294	380 - 480, 3~, 50/60	5800

*Total cooling output 50Hz L35 L35 to DIN EN 14511

Spare parts available from <http://rittal.com.au> >> Support>> Service>> Spare Parts

Enclosure Climate Control SK



Generation “Blue e” Save energy permanently with Rittal cooling units

Rittal’s Blue e range, with a cooling output ranging from 500 W to 4,000 W (depending on the application) can help achieve energy savings up to 45% (ideally 70% compared with a conventional Rittal TopTherm Plus cooling unit in field trials).

The higher coefficient of performance (COP), which is 42% higher (from 1.2 to 1.7) with 1,000 W test equipment, for example, is the product of years of research and development. It also results from the ideal interaction of all the components responsible for the cooling output.

The first step towards improving the efficiency of the new cooling units with nano-coating involves the entire geometry of the cooling components’ configuration. The component manufacturer systematically analysed existing devices and - wherever possible - improved their efficiency. This related to the design of the condensers,

evaporators, cooling fins, pipe bends and all the other refrigeration components.

In a second step, Rittal optimised the fan technology. EC (Electronic Communication) technology is used in most of the fan motors. In these motors, designed as external rotor motors, the traditional mechanical pole reversal is replaced by electronic commutation, which functions without wear, sparks or interference. The motors have a dynamically balanced rotor with multi-polar magnets. The rotor position is recorded by several Hall-effect sensors. Motor supply and control is achieved via an external electronic operating system that has a very high efficiency at all speeds. Precision bearings ensure a long service life and low noise generation.

Eco-mode Controls

Intelligent, targeted use of energy thanks to the new-eco-mode control from Rittal.

The evaporator fan is switched off as required depending on the internal enclosure temperature and therefore no longer runs throughout.

1. Cooling switched off: the interior fan only runs to ensure air circulation inside the enclosure
2. The interior fan is switched off
3. The interior fan is switched on for 30 seconds every 10 minutes to briefly blend the air
4. The interior fan is switched back on

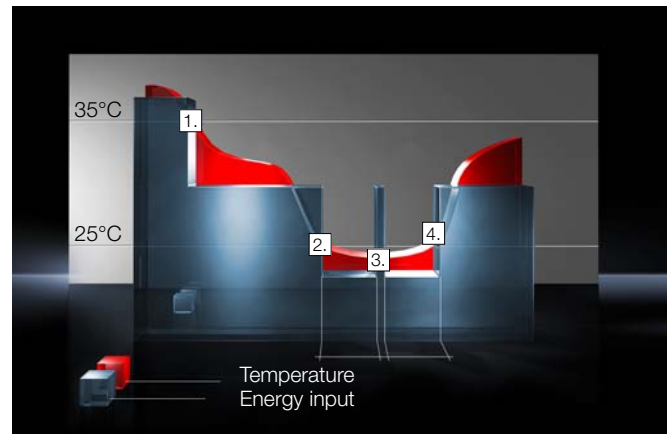

Nanotechnology for TopTherm Climate Control Units

Rittal cooling units of the TopTherm series are often installed in extremely tough operating environments: Dry dust, oil-laden air and other aggressive ambient influences mean time consuming and expensive cleaning and maintenance. The water, dirt and oil-repellent properties of the innovative RiNano coating applied to the heat exchangers ensures a constant cooling performance over a much longer period – which quickly adds up to significant time and cost savings.

RiNano saves time and money

- Reduced contamination of the heat exchanger
- High resilience of the RiNano coating
- Significantly simpler cleaning
- Extended service and maintenance intervals cut costs
- No time-consuming removal and remounting of the cooling unit
- Filter mats no longer necessary for many applications
- Longer service life of metal filter mats
- Increased energy efficiency

Rittal Therm 6.3

Rittal Therm 6.3 is a calculation program for enclosure climate control.

The Rittal Therm 6.3 software package takes care of complex calculations of climate control requirements. A user-friendly interface guides the operator to the most suitable, correctly dimensioned climate control component.

Available for download from rittal.com.au



Wall Mounted Cooling Units sk

Wall Mounted Cooling Units offer top design, quality and performance with a host of assembly benefits. With the added option to mount the units externally, partial internally or fully internally in the enclosure, the available space is maximised.

There are seven models to choose from with nominal cooling outputs ranging from 300 to 4000 watts. They are also available in stainless steel for use with stainless steel enclosures. Additional accessories include door switches, which deactivate the unit when the doors are open, thereby helping to prevent condensation.

Supply Includes

- Nano-coated condenser
- Integral electric condensate evaporation, 1000W units and above
- Fully wired ready for connection
- Drilling template
- Assembly parts



Mild Steel		Stainless Steel		Width mm	Height mm	Depth mm	Operating Voltage (V) (50/60Hz)	Cooling Output (W)*
Basic Control	Comfort Control	Basic Control	Comfort Control					
3302100	-	3302200	-	280	550	140	230	360
3302110	-	3302210	-	280	550	140	115	360
-	3303500	-	3303600	280	550	210	230	550
-	3303510	-	3303610	280	550	210	115	660
-	3361500	-	3361600	280	550	206	230	850
-	3361510	-	3361610	280	550	206	115	890
-	3361540	-	3361640	280	550	206	400	850
-	3304500	-	3304600	400	950	260	230	1100
-	3304510	-	3304610	400	950	260	115	1100
-	3304540	-	3304640	400	950	260	400/460	1100
-	3305500	-	3305600	400	950	260	230	1600
-	3305510	-	3305610	400	950	260	115	1600
-	3305540	-	3305640	400	950	260	400/460	1600
-	3328500	-	3328600	400	1580	295	230	2200
-	3328510	-	3328610	400	1580	295	115	2200
-	3328540	-	3328640	400	1580	295	400/460	2200
-	3329500	-	3329600	400	1580	295	230	2550
-	3329510	-	3329610	400	1580	295	115	2550
-	3329540	-	3329640	400	1580	295	400/460	2550
-	3332540	-	3332640	500	1580	340	400/460	3950

*Total cooling output 50Hz L35 L35 to DIN EN 14511 [Spare parts available from http://rittal.com.au](http://rittal.com.au) >> Support>> Service>> Spare Parts

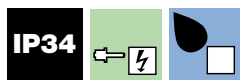

External Circuit



Internal Circuit

For approvals detailed drawing and performance diagrams refer to rittal.com.au

Roof Mounted Cooling Units SK

Roof Mounted Cooling Units offer top design, quality and performance with a host of assembly benefits and sophisticated air routing. These units allow maximum utilisation of the available space above the enclosure.

There are four models to choose from with nominal cooling outputs ranging from 500 to 4000 watts. They are also available in stainless steel for applications where corrosion resistance is required. Additional accessories including ducting kits and door switches aim to further maximise the efficiency of heat dissipation from the enclosure.

Supply Includes

- Nano-coated condenser
- Integral electric condensate evaporation
- Fully wired ready for connection
- Drilling template
- Assembly parts



Mild Steel Comfort Control	Stainless Steel Comfort Control	Width mm	Height mm	Depth mm	Operating Voltage (V) (50/60Hz)	Cooling Output (W)*
3382500	3382600	597	417	380	230	550
3382510	3382610	597	417	380	115	550
3359500	3359600	597	417	380	230	770
3359510	3359610	597	417	380	115	770
3359540	3359640	597	417	380	400	770
3383500	3383600	597	417	475	230	1000
3383510	3383610	597	417	475	115	1000
3383540	3383640	597	417	475	400	1000
3384500	3384600	597	417	475	230	1500
3384510	3384610	597	417	475	115	1500
3384540	3384640	597	417	475	400	1500
3385500	3385600	597	417	475	230	2000
3385510	3385610	597	417	475	115	2000
3385540	3385640	597	417	475	400	2000
3386540	3386640	796	470	580	400/460	3000
3387540	3387640	796	470	580	400/460	3800

*Total cooling output 50Hz L35 L35 to DIN EN 14511 **Spare parts available from <http://rittal.com.au> >> Support>> Service>> Spare Parts**

Accessories

Air Duct System

Model No.	For Unit	Pack of
3286870	3209.../ 3210.../ 3273.../ 3359.../ 3382.../ 3383.../ 3384.../ 3385...	1
3286970	3386.../ 3387...	1

Stainless steel
Rust Free

RAL 7035
LIGHT GREY

IP34

← ⚡

□

IP54

⋮ ⚡

□

External Circuit Internal Circuit

Roof Mounted Cooling Units SK

Especially for Office Applications

Low noise level (considerably quieter than cooling units for industrial applications).

Supply Includes

- Nano-coated condenser and integral electronic condensate evaporation.
- Fully wired ready for connection, including drilling template and assembly parts.

Material

- Mild Steel Exterior

For approvals detailed drawing and performance diagrams refer to rittal.com.au



Model No.	Width mm	Height mm	Depth mm	Operating Voltage (V)	Cooling Output (W)*
3273500	597	417	475	230	1100
3273515	597	417	475	115	1100
3301800	597	417	895	230	3000

*Total cooling output 50Hz L35 L35 to DIN EN 14511

Spare parts available from <http://rittal.com.au> >> Support>> Service>> Spare Parts

For Cooling IT equipment

Temperature Control

Control of the server air infeed temperature

Material

- Sheet Steel

Colour

- RAL 7035

Protection category IP TO IEC 60 529:

- External circuit IP 34
- Internal circuit IP 54

Supply includes:

- Nano-coated condenser
- Integral electric condensate evaporation
- Fully wired ready for connection
- Drilling template
- Assembly parts

Note:

- A roof plate with cut-out to match the enclosure dimensions is required

Model No.	Width mm	Height mm	Depth mm	Operating Voltage (V)	Cooling Output (W)*
3301800	597	417	895	230	3000

Wall Mounted Cooling Units NEMA 4x

Material

- Stainless Steel Exterior

Supply includes

- Nano-coated condenser
- Integral electric condensate evaporation
- Wired ready for connection (plug-in terminal strip)
- Drilling template
- Assembly parts

For approvals detailed drawing and performance diagrams refer to rittal.com.au



Model No. Comfort Controller	Width mm	Height mm	Depth mm	Rated Operating Voltage (V - Hz)	Cooling Output (W)*
3303504	285	620	298	230 - 50/60	550
3303514	285	620	298	115 - 60	660
3304504	405	1020	358	230 - 50/60	1100
3304514	405	1020	358	115 - 50/60	1100
3304544	405	1020	358	400 - 50/460 - 60	1100
3305504	405	1020	358	230 - 50/60	1600
3305514	405	1020	358	115 - 50/60	1600
3305544	405	1020	358	400 - 50/460 - 60	1600
3328504	405	1650	388	230 - 50/60	2200
3328514	405	1650	388	115 - 50/60	2200
3328544	405	1650	388	400 - 50/460 - 60	2200
3329504	405	1650	388	230 - 50/60	2550
3329514	405	1650	388	115 - 50/60	2550
3329544	405	1650	388	400 - 50/460 - 60	2550

*Total cooling output 50Hz L35 L35 to DIN EN 14511

Spare parts available from <http://rittal.com.au> >> Support>> Service>> Spare Parts

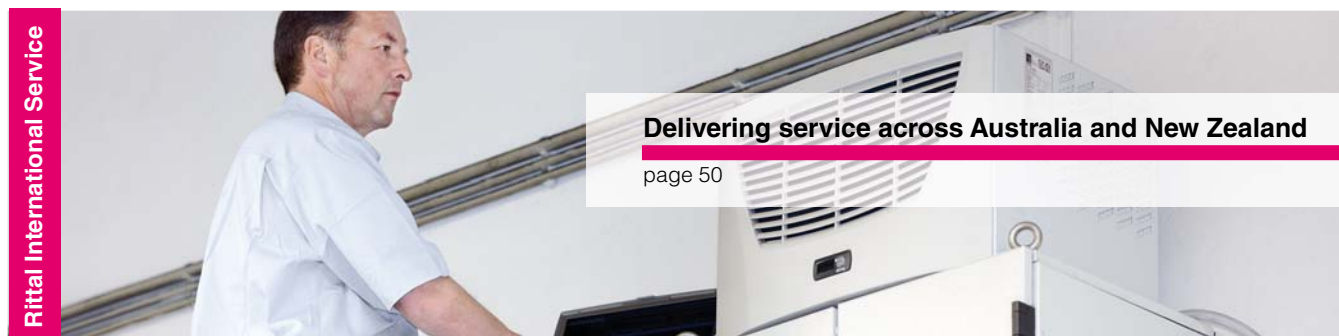

Rittal International Service

Delivering service across Australia and New Zealand

page 50

Enclosure Heaters sk

Enclosure heaters protect your equipment from condensation and corrosion. Rittal heaters are designed to produce the necessary heat, while maintaining their compact and robust black anodised aluminium construction.

This series is made up of seven different capacity heaters, with thermal outputs ranging from 10 to 800 watts. Surface temperature and power consumption are minimised through the use of thermistors (PTCs), which regulate the thermal output according to the enclosure internal temperature.

Supply Includes

PTC heater with quick-fit and assembly parts.

Note:

- Thermostat (3110000) is recommended for precise temperature control in the enclosure
- In order to prevent condensation on assemblies, hygrostat (3118000) is recommended to regulate heating
- In larger enclosures, even heat distribution is best achieved by installing several low-output heaters
- The installation of heaters is generally advisable, even when using heat exchangers and cooling units, in order to prevent condensation



Heater Sizing

In order to install the appropriate capacity heater, the required thermal output can be calculated as:

	Example:
Calculate the enclosure surface area in m ²	A 4
Select the minimum internal temperature that you wish to maintain in the enclosure in °C	Ti 15
Select the minimum ambient temperature of the enclosure surrounds in °C	Tu 5
Calculate the temperature difference $T_i - T_u = \Delta T$	ΔT 10
Heat transfer coefficient of steel $k = 5.5 \text{ W/m}^2\text{K}$	K 5.5
Thermal output calculated as: $Q_H = A \times \Delta T \times k$	Q_H 220W

Without Fan-Continuous Thermal Output 8-150 W

Model No.	Width mm	Height mm	Depth mm	Operating Voltage (50/60Hz)	Operating Thermal Output (W @ T _i =10°C)	Pre-fuse T
3105310	45	120	46	110-240V	8 - 10	2A
3105320	45	120	46	110-240V	18 - 20	2A
3105330	64	155	56	110-240V	23 - 30	4A
3105340	64	155	56	110-240V	49 - 50	4A
3105350	64	230	56	110-240V	63 - 75	4A
3105360	90	165	75	110-240V	86 - 100	4A
3105370	90	180	75	110-240V	130 - 150	4A

With Fan-Continuous Thermal Output 250-800 W

Model No.	Width mm	Height mm	Depth mm	Operating Voltage (50/60Hz)	Operating Thermal Output (W @ T _i =10°C)	Pre-fuse T
3105410	103	200	103	110	250	4
3105380	103	200	103	230	250	4
3105420	103	200	103	110	400	6
3105390	103	200	103	230	400	6
3105430	103	200	103	110	800	10
3105400	103	200	103	230	800	6

TopTherm Fans and Filter Units



More Pressure. Higher Flow Rates

Assembly Without Tools

- Straightforward assembly, exchange and maintenance with no need for tools of any kind
- Simple reversal of the air flow direction by turning the fan module
- Individual positioning of the power connection
- Spring clamp terminals for electrical connection without tools
- Louvred grill latch for fast filter mat replacement without tools



Performance diagram

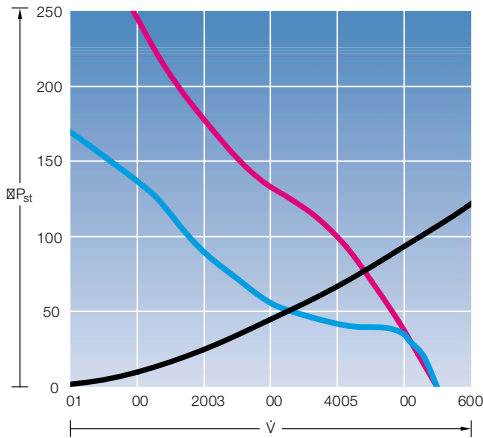

- V = Volumetric flow (m³/h)
- ΔPst = Stat. pressure difference (Pa)
- = Resistance curve
Outlet filter SK 3243.200
- = old 50 Hz
Fan-and-filter unit SK 3326.xxx
- = new 50 Hz
Fan-and-filter unit SK 3243.xxx

Efficient Technology

- Air throughput from 20 to 700 m³/h
- New diagonal fan technology for greater pressure stability and constant air flows in use, even with a contaminated filter mat
- Minimum installation depth
- Flow-optimised air routing
- Extended service life of filter mats and thus longer maintenance intervals



Air Routing

- Intelligent symbiosis of radial and axial fan technology
- Air flow spreads diagonally from the fan, promoting a more even air distribution in the enclosure

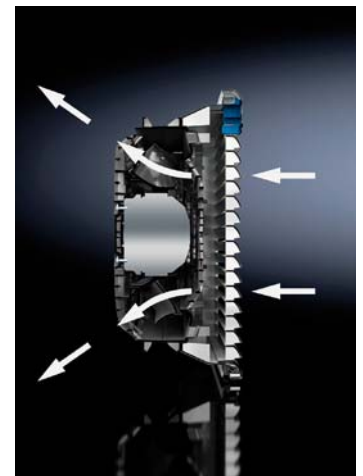

TopTherm Fans and Filter Units

Air Throughout

Fan and Filter Mat	Outlet Filter	Width (B1) mm	Height (H1) mm	Depth (T2) mm	Air Flow Rate (m³/h) Unimpeded	Voltage (V) (50/60Hz)	Rated Current A
3237100	3237200	116.5	116.5	43	20/25	230	0.065/0.052
3237110	3237200	116.5	116.5	43	20/25	115	0.12/0.10
3237124	3237200	116.5	116.5	43	20	24 (DC)	0.125
3238100	3238200	148.5	148.5	58.5	55/66	230	0.12/0.11
3238110	3238200	148.5	148.5	58.5	55/66	115	0.24/0.22
3238124	3238200	148.5	148.5	58.5	55	24 (DC)	0.23
3239100	3239200	204	204	90	105/120	230	0.12/0.11
3239110	3239200	204	204	90	105/120	115	0.24/0.22
3239124	3239200	204	204	90	105	24 (DC)	0.23
3240100	3240200	255	255	107	180/160	230	0.21/0.19
3240110	3240200	255	255	107	180/160	115	0.42/0.38
3240124	3240200	255	255	107	180	24 (DC)	0.43
3241100	3240200	255	255	107	230/250	230	0.26/0.24
3241110	3240200	255	255	107	230/250	115	0.52/0.48
3241124	3240200	255	255	107	230	24 (DC)	0.78
3243100	3243200	323	323	118.5	550/600	230	0.37/0.39
3243110	3243200	323	323	118.5	550/600	115	0.75/0.80
3244100	3243200	323	323	130.5	700/770	230	0.43/0.60
3244110	3243200	323	323	130.5	700/770	115	0.9/1.25
3244140	3243200	323	323	130.5	700/770	400/460	0.17/0.21

Special voltages available on request. We reserve the right to make technical modifications, EMC fans/filters available.

Hose Proof Hood

Model No.	For Fan and Filter Unit	Width mm	Height mm	Depth mm
3237080	3237...	150	230	40
3238080	3238...	176	245	55
3239080	3239...	233	330	55
3240080	3240.../ 3241...	282	390	85
3243080	3243.../ 3244...	350	480	110
3245080	3245...	350	480	160



Control/Regulation

Model No.	Description	Pack of
3110000	Thermostat	1
3118000	Hydrostat	1



Standard fan/filter



Fan/filter with fine filter



Fan/filter with fine filter mat and hose proof hood

Roof Mounted Filter Fans

- Just one mounting cut-out for all output categories (258 x 258 mm)
- Optimum efficiency, thanks to sophisticated air routing with minimal pressure losses
- Innovative clamping attachment supports flexible locking optionally from the outside or inside and ensures a high protection category
- Easy electrical connection via plug terminal
- Good accessibility permits fast filter mat changes

Protection Category

- IP 22 without filter mat
- IP 55 with filter mat

Supply includes

- Complete unit ready to install, including filter mat



Air throughput, unimpeded air flow 500 - 873 m³/h

Fan and Filter Mat	Outlet Filter	Width mm	Height mm	Depth mm	Air Flow Rate (m³/h) Unimpeded	Voltage (V) (Hz)	Rated Current A
3138000	3243200	400	133	400	-	-	-
3139100	3243200	400	133	400	417 / 446	230, 1~, 50/60	0.22 / 0.27
3139110	3243200	400	133	400	417 / 446	115, 1~, 50/60	0.43 / 0.55
3140100	3243200	400	133	400	725 / 759	230, 1~, 50/60	0.43 / 0.56
3140110	3243200	400	133	400	725 / 759	115, 1~, 50/60	0.88 / 1.17
3140140	3243200	400	133	400	700 / 749	400, 3~, 50/60 460, 3~, 60	0.17 / 0.19

Conversion table for roof-mounted fans

Air throughput, unimpeded air flow		500 m³/h	800 m³/h	1000 m³/h
without fan				
new	3138000	-	-	-
old	8801380	3148007	-	-
230 V				
new	-	3139100	3140100	3140500
old	-	3149007	3149420	3149820
115 V				
new	-	3139110	3140110	3140510
old	-	3169007	3149410	3149810
400 V				
new	-	-	3140140	-
old	-	3149.440	3149.840	-
Spare filter mats				
new	3174100	-	-	-
old	-	3174000	3174000	3174000

Accessories

Filter Mats (for cooling units)

Model No.	Unit	Dimensions mm	Pack of
3286110	3302300/ 3302310	190 x 95 x 10	3
3286300	3302.../ 3303.../ 3361...	265 x 200 x 10	3
3286400	3304.../ 3305.../ 3328.../ 3329.../ 3332.../ 3366...	344 x 268 x 10	3
3286500	3273.../ 3382.../ 3383.../ 3384.../ 3385.../ 3359...	530 x 255 x 10	3
3286600	3386.../ 3387...	720 x 300 x 10	3
3253010	3377...	205 x 210 x 10	3
3285900	3186930 / 3187930 / 3188940 / 3189940	380 x 358 x 10	3



Metal Filters (for cooling units)

Model No.	Unit	Dimensions mm	Pack of
3286120	3302300/ 3302310	190 x 95 x 10	1
3286310	3302100 / 3302110 / 3303.../ 3361...	265 x 200 x 10	1
3286410	3304.../ 3305.../ 3328.../ 3329.../ 3332.../ 3366...	344 x 268 x 10	1
3286510	3273.../ 3382.../ 3383.../ 3384.../ 3385.../ 3359...	530 x 255 x 10	1
3286610	3386.../ 3387...	720 x 300 x 10	1
3253220	3377...	255 x 200 x 10	1
3285910	3186930 / 3187930 / 3188940 / 3189940	380 x 358 x 10	1



Spare Filter Mats (for fan/outlet filter)

Model No.	Fan and Filter Unit	Filter Class DIN EN 779	Pack of
3321700	3237...	G2	5
3322700	3238...	G2	5
3171100	3239...	G3	5
3172100	3240.../ 3241...	G3	5
3173100	3243.../ 3244...	G3	5
3174100	3138.../ 3139.../ 3140...	G3	12



Fine Filter Mats (for fan/outlet filter)

Model No.	Fan and Filter Unit	Filter Class DIN EN 779	Pack of
3238055	3238...	F5	5
3181100	3239...	F5	5
3182100	3240.../ 3241	F5	5
3183100	3243.../ 3244.../ 3245...	F5	5



The Three Stage Coating Process

Coating Process	Technical Properties	Technical Specifications	
1. Degreasing and Nanoceramic Coating	<ul style="list-style-type: none"> Improved corrosion protection through the provision of a closed, inorganic layer of high density in which nanoparticles are embedded Optimum paint adhesion as a result of the increased surface area Free from phosphates, solvents and toxic heavy metals Lower energy requirement: because no heating is necessary for the application Long term better protection devices 		
2. Anodic Dipcoat Priming	Formation of even layers on all surfaces, edges and in cavities, which creates a high degree of corrosion protection during the build-up process.	Coat thickness	approx. 20 µm
		Cupping index DIN53 156	≥ 4 mm
		Bucholz hardness DIN53 153	≥ 80
		Cross cutting DIN 53 151	Gt 0
	The primer is readily overpainted and is free from the heavy metals, chromate and silicone.		
Stove Enamelling			
3. Textured Powder Coating	The distinguishing features of powder coating include a high level of mechanical resistance, excellent corrosion protection, good resistance to chemicals, temperature and weather, and its facility for decontamination.	Coat thickness (external hardness)	approx. 50 - 70 µm
		Cupping index DIN53 156	≥ 4 mm
		Bucholz hardness DIN53 153	≥ 80
		Cross cutting DIN 53 151	Gt 0
	The primer is readily overpainted and is free from the heavy metals, chromate and silicone.		
Stove Enamelling			

Protection Categories to IEC 60 529 (EN 60 529)















The IP protection category is characterised by two numbers.

Example of protection category e.g. IP 43:

IP Code Letters

4 First Characteristic Numeral

3 Second Characteristic Numeral

Degrees of Protection for Protection Against Contact and Foreign Bodies: First Characteristic Numeral			Degrees of Protection for Protection Against Water: Second Characteristic Numeral		
First Characteristic Numeral	Degree of Protection		Second Characteristic Numeral	Degree of Protection	
	Description	Explanation		Description	Explanation
	1 Protected against solid foreign objects with a diameter of 50 mm and greater	The object probe, a sphere 50 mm in diameter, must not penetrate fully*		1 Protected against vertically falling water	Vertically falling drops shall have no harmful effects.
	2 Protected against solid foreign objects with a diameter of 12.5 mm and greater	The object probe, a sphere 12.5 mm in diameter, must not penetrate fully* The articulated test finger may penetrate up to its length of 80 mm, but adequate distance must be adhered to		2 Protected against vertically falling water drops when the enclosure is tilted up to 15°	Vertically falling drops must not have any harmful effects when the enclosure is tilted up to 15° in both directions from the vertical
	3 Protected against solid foreign objects with a diameter of 2.5 mm and greater	The object probe, a sphere 2.5 mm in diameter, must not penetrate at all*		3 Protected against spraying water	Water sprayed at an angle of up to 60° on either side of the vertical must have no harmful effects
	4 Protected against solid foreign objects with a diameter of 1.0 mm and greater	The object probe, a sphere 1.0 mm in diameter, must not penetrate at all*		4 Protected against splashing water	Water splashed on the enclosure from every direction must not have any adverse effects
	5 Dust-protected	The ingress of dust at a partial vacuum of 20 mbar inside the enclosure		5 Protected against water jets	Water directed at the enclosure from every direction in a jet must not have any harmful effects
	6 Dust-tight	No ingress of dust at a partial vacuum of 20 mbar inside the enclosure		6 Protected against powerful water jets	Water directed at the enclosure from every direction in a powerful jet must not have any harmful effects
				7 Protected against the effects of temporary immersion in water	Water must not ingress to such an extent as to cause harmful effects when the enclosure is temporarily immersed in water under standardised pressure and time conditions
				8 Protected against the effects of continuous immersion in water	Water must not penetrate to such an extent as to cause adverse effects when the enclosure is permanently immersed in water under conditions which must be agreed between the manufacturer and the user. However, the conditions must be more difficult than for characteristic numeral 7
				9K**	Water directed at the enclosure from every direction under greatly increased pressure must not have any adverse effects

* The full diameter of the object probe must not pass through an opening of the enclosure.

** This test is not regulated by IEC 60529/09.2000 (EN 60 529/09.2000), but by DIN EN 40 050, part 9. Extracts from BS EN 60.259: 1991 are reproduced with the permission of BSI. Complete editions of the standards can be obtained from BSI Customer Services, 889 Chiswick High Road, London W4 4AL

Modification Centre

RITTAL PROVIDING IN HOUSE MODIFICATION FACILITIES

Our dedicated Modification Centre team provide an in house modification facility capable of milling, drilling and tapping (metric) and painting services.

What we do

- work with approved customer drawings to provide solutions
- provide cutouts and manufacturing for customers
- assemble racks to customer specified configurations
- handle complex and large scale projects.

Rittal Milling Centre Capabilities

Rittal provides in house access to the superior Rittal Milling machine offering an extensive range of value added modifications such as:

- Computerised drilled holes, threads, or cutouts of any shape in all materials of panel building.



- Processing of flat or folded surfaces on any Rittal product enclosure
- Ability to modify all surfaces of an enclosure including mounting plate and gland plate.

Contact your Rittal Account Manager for more information.

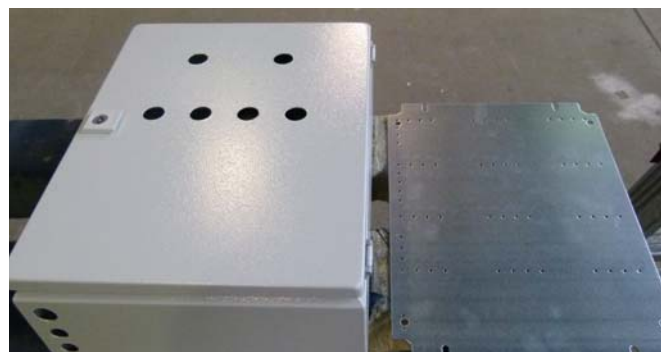

Rittal Service

RITTAL DELIVERS SERVICE ACROSS AUSTRALIA AND NEW ZEALAND



24 hour availability.

Whenever, wherever and however you need us, we are always on hand to offer you our assistance. Simply give us a call, send an email or visit www.rittal.com.au



Repairing.

Our highly qualified service technicians are out on the road for you. Rittal offers fast, flexible and reliable assistance when you need it.



Flexible contracts.

As flexible and individual as your requirements. We offer tailored Service Agreements which guarantee you all the benefits of life cycle management for the long-term future.



Spare parts.

Stocks of standard spare parts and customer-specific components ensure fast and reliable spare parts availability.



Warranty extension.

Extend the life of your investments with optional warranty extension for up to 5 years on service contracts.

Rittal Service

Reliability and peace of mind

Contact us for more information on Service

AUSTRALIA: 1800 676 169
NEW ZEALAND: 0800 748 737

service@rittal.com.au

SERVICE OPTIONS	Availability	Response Time	Spare Parts Availability	Maintenance	Extended Warranty	Commissioning
BASIC	Business hours	Next working day	Standard	Product dependent	Optional	Not included
COMFORT	Business hours	Next day	Standard	Product dependent	Optional	Not included
ADVANCED	24 Hours, 365 days a year	8 Hours	24 Hours	Product dependent	Included	Included
FULL	24 Hours, 365 days a year	4 Hours	24 Hours	Product dependent	Included	Included
CUSTOMISED	24 Hours, 365 days a year	4 Hours	Individual concept	Individual (min 2 x per year)	Optional	Included

Tools



RiCAD

Access CAD drawings

<http://www.rittal.com.au>

>> Support >> Software >> CAD data >> RiCAD-3D



Spare Parts for Enclosure and Climate Control

<http://www.rittal.com.au>

>> Support >> Service >> Spare Parts

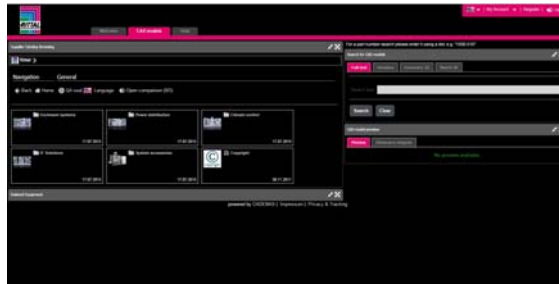

Parts Community

Search parts and download drawings

<http://rittal.partcommunity.com>



Configurators

Select an economically efficient solution for all your needs

<http://www.rittal.com.au>

>> Support >> Software >> Configurators



RiTherm

Takes care of the complex calculation of climate control requirements.

<http://www.rittal.com.au>

>> Support >> Software >> Planning Software

Android and iPhone App also available



*Alternate lock cylinders CL001, CL003, 92268, etc. available on request

Model No. (with Mounting Plate)	Cat 34. 44-47		1032500	1035500	1036500	1033500	1034500	1030500	1031500	1380500	1038500	1338500	1045500	1037500	1050500	1350500	1057500	1039500	1339500	1060500	1054500	1360500	1076500	1376500	1058500	1090500	1260500	1077500	1073500	1055500	1180500	1280500	1100500	1130500	1110500		
Dimensions																																					
Width			200	200	300	300	300	380	380	380	380	380	400	400	500	500	500	600	600	600	600	600	600	600	600	600	600	760	760	800	800	800	1000	1000	1000		
Height			300	300	300	300	400	300	300	380	600	600	500	800	500	500	700	380	380	600	600	600	760	760	800	1000	1200	760	760	600	1000	1200	760	760	1000		
Depth			120	155	155	210	210	155	210	210	210	350	210	210	210	300	250	210	350	210	250	350	210	350	250	250	300	210	300	300	300	300	210	300	300		
Base/Plinth Wall Mount-																																					
Base / Plinth (100mm)	495		-	-	-	-	-	-	-	-	-	-	-	-	-	-	-	-	-	-	-	-	-	-	-	-	2816200	-	-	-	2818200	2818200	-	2801200	2801200		
Base / Plinth (200mm)	495		-	-	-	-	-	-	-	-	-	-	-	-	-	-	-	-	-	-	-	-	-	-	-	-	2826200	-	-	-	2828200	2828200	-	2802200	2802200		
Eyebolts	562		-	-	-	-	-	-	-	-	-	-	-	-	-	-	-	-	-	-	-	-	-	-	-	-	2509000	-	-	-	-	2509000	-	-	-		
Wall Bracket (Mild Steel - 10mm)	563		2508010	2508010	2508100	2508010	2508010	2508010	2508010	2508010	2508010	2508010	2508010	2508010	2508010	2508010	2508010	2508010	2508010	2508010	2508010	2508010	2508010	2508010	2508010	2508010	2508010	2508010	2508010	2508010	2508010	2508010	2508010	2508010	2508010	2508010	
Wall Bracket (Mild Steel - 40mm)	563		2503010	2503010	2503010	2503010	2503010	2503010	2503010	2503010	2503010	2503010	2503010	2503010	2503010	2503010	2503010	2503010	2503010	2503010	2503010	2503010	2503010	2503010	2503010	2503010	2503010	2503010	2503010	2503010	2503010	2503010	2503010	2503010	2503010	2503010	
Wall Angle (Mild Steel)	564		2505510	2505510	2505510	2505510	2505510	2505510	2505510	2505510	2505510	2505510	2505510	2505510	2505510	2505510	2505510	2505510	2505510	2505510	2505510	2505510	2505510	2505510	2505510	2505510	2505510	2505510	2505510	2505510	2505510	2505510	2505510	2505510	2505510	2505510	
Handles Locks*																																					
Plastic Handle Version B (3524E)	545		2576000	2576000	2576000	2576000	2576000	2576000	2576000	2576000	2576000	2576000	2576000	2576000	2576000	2576000	2576000	2576000	2576000	2576000	2576000	2576000	2576000	2576000	2576000	2576000	2576000	-	2576000	2576000	2576000	2576000	2576000	-	2576000	2576000	
T-Handle Version B (3524E)	544-545		2575000	2575000	2575000	2575000	2575000	2575000	2575000	2575000	2575000	2575000	2575000	2575000	2575000	2575000	2575000	2575000	2575000	2575000	2575000	2575000	2575000	2575000	2575000	2575000	2575000	-	2575000	2575000	2575000	2575000	2575000	-	2575000	2575000	
Ergoform-S (3524E)			-	-	-	-	-	-	-	-	-	-	-	-	-	-	-	-	-	-	-	-	-	-	-	-	2435000 2467000	-	-	-	-	2435000 2467000	-	-	-		
Interior Installation																																					
Support Rails	589		-	-	-	2383210	2383210	-	2383210	2383210	2383210	2383350	2383210	2383210	2383210	2383300	2383250	2383210	2383350	2383210	2383250	2383350	2383210	2383350	2383250	2383250	2383300	2383210	2383300	2383300	2383300	2383300	2383300	2383300	2383210	2383300	2383300
Support Rails	589		-	-	-	2383210	2383210	-	2383210	2383210	2383210	2383350	2383210	2383210	2383210	2383300	2383250	2383210	2383350	2383210	2383250	2383350	2383210	2383350	2383250	2383250	2383300	2383210	2383300	2383300	2383300	2383300	2383300	2383300	2383210	2383300	2383300
Cable Conduit & Cable Conduit Holder Ø29	639		2589000 2591000	2589000 2591000	2589000 2591000	2589000 2591000	2589000 2591000	2589000 2591000	2589000 2591000	2589000 2591000	2589000 2591000	2589000 2591000	2589000 2591000	2589000 2591000	2589000 2591000	2589000 2591000	2589000 2591000	2589000 2591000	2589000 2591000	2589000 2591000	2589000 2591000	2589000 2591000	2589000 2591000	2589000 2591000	2589000 2591000	2589000 2591000	2589000 2591000	2589000 2591000	2589000 2591000	2589000 2591000	2589000 2591000	2589000 2591000	2589000 2591000	2589000 2591000	2589000 2591000		
Wiring Plan Pocket (A4 - Portrait)	553		-	-	-	-	2514000	2514000	2514000	2514000	2514000	2514000	2514000	2514000	2514000	2514000	2514000	2514000	2514000	2514000	2514000	2514000	2514000	2514000	2514000	2514000	2514000	2514000	2514000	2514000	2514000	2514000	2514000	2514000	2514000	2514000	
Universal Bracket	598		2373000	2373000	2373000	2373000	2373000	2373000	2373000	2373000	2373000	2373000	2373000	-	2373000	2373000	2373000	2373000	2373000	2373000	2373000	2373000	2373000	2373000	2373000	2373000	2373000	2373000	2373000	2373000	2373000	2373000	2373000	2373000	2373000	2373000	
Door Stay			-	-	-	2519000	2519000	2519000	2519000	2519000	2519000	2519000	2519000	-	2519000	2519000	2519000	2519000	2519000	2519000	2519000	2519000	2519000	2519000	2519000	2519000	2519000	2519000	2519000	2519000	2519000	2519000	2519000	2519000	2519000	2519000	
Lights																																					
Lights (Door-Operated Switch)	610		-	-	-	-	-	-	-	-	-	-	-	-	4138150	4138150	4138150	4138150	4138150	4138150	4138150	4138150	4138150	4138150	4138150	4138150	4138150	4138150	4138150	4138150	4138150	4138150	4138150	4138150	4138150		
Connection Cable	614		-	-	-	-	-	-	-	-	-	-	-	-	4315100	4315100	4315100	4315100	4315100	4315100	4315100	4315100	4315100	4315100	4315100	4315100	4315100	4315100	4315100	4315100	4315100	4315100	4315100	4315100	4315100		
Rain Canopies																																					
Mild Steel			-	-	-	-	-	-	2501500	2501500	2501500	-	-	-	-	-	2502500	2511500	2502500	-	2511500	2511500	-	-	-	-	-	-	-	-	-	-	-	-	-	-	
Stainless Steel			-	2470000	-	2361000	2361000	2471000	2472000	2472000	2472000	-	-	-	2362000	-	-	2473000	-	2473000	-	-	2473000	-	-	-	-	-	-	2474000	2475000	2475000	2475000	2475000	-	2363000	2363000

