

Panel Accessories



PRICE LIST

Effective from 01.07.2021



salzer

Established in 1985 in a time-bound collaboration with Saelzer Schaltegerate Fabrik GmbH to manufacture rotary switches, and headquartered in Coimbatore, Salzer has grown into an independent multi-product entity with a wide basket of Electrical Products, covering a variety of applications for the Domestic, Industrial & Automobile segments.

With a wide network and business association with a major engineering conglomerate on specific product ranges in domestic market, Salzer products are also available as a preferred choice in over 40 countries worldwide.



Contents

Rotary Switches	5
Load Break Switches	14
DC Isolators & Changeover	16
Cable Ducts	18
Relay & Relay Modules	20
ACCL	25
Terminal Connectors	27
Limit and Foot Switches	32
Plugs & Sockets	34

 GST 18%

TYPE CHART

ROTARY SWITCHES

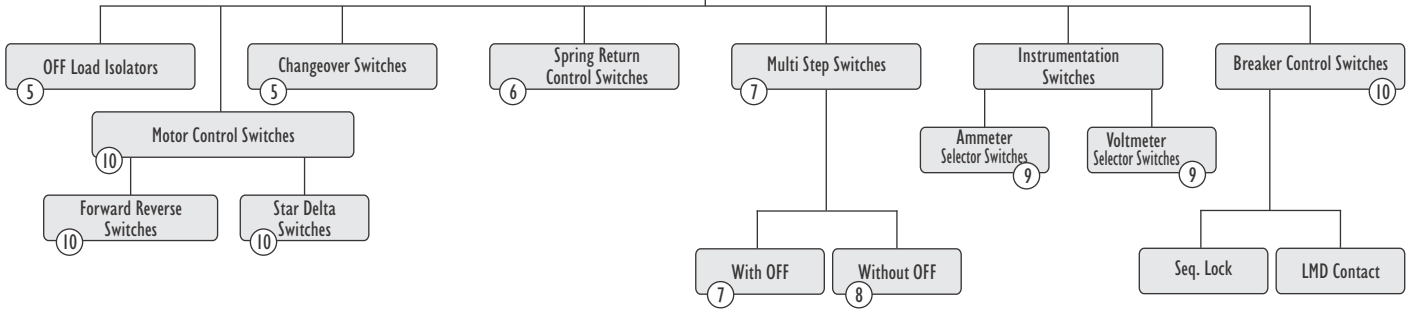

LOAD BREAK SWITCHES

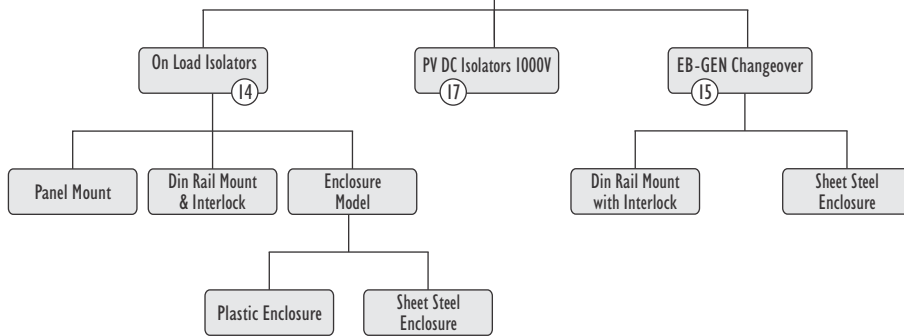

CABLE DUCTS

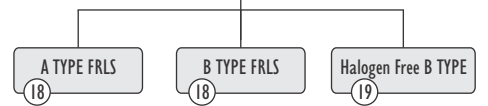

RELAYS

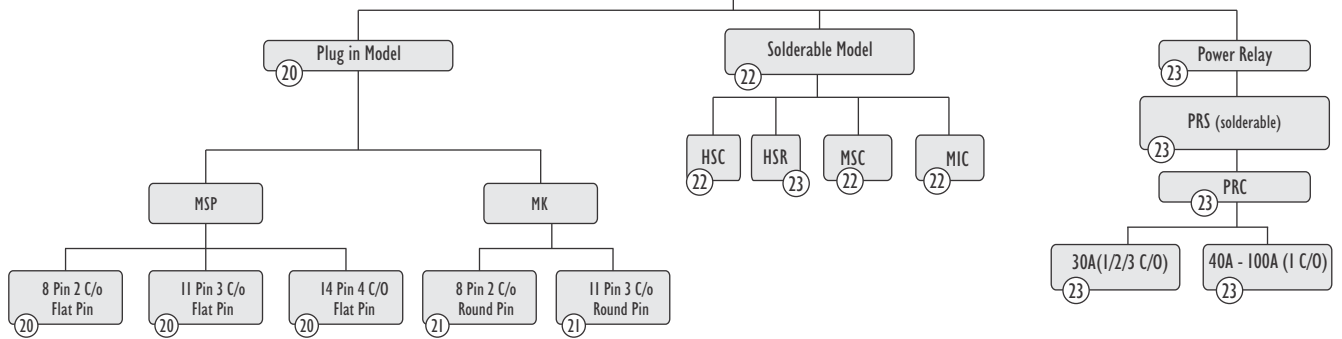

RELAY MODULE

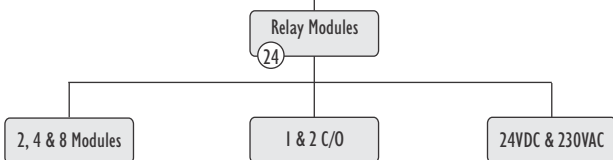

TERMINAL CONNECTORS

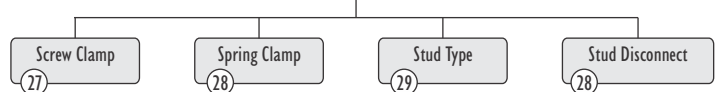

PLUG & SOCKETS

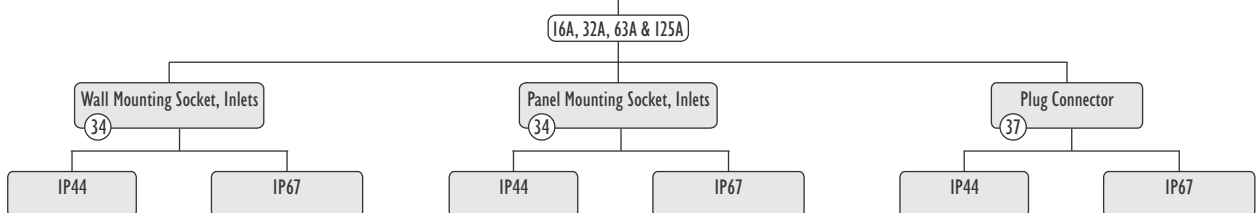

Cam Operated Rotary Switches (8536)



Isolators Switches (ON-OFF Switches)



60° Operation	90° Operation	90° Operation Complete Rotation	Description	M.R.P. (₹) Per Unit									
				Cat. No.									
61001	61191	61195	1 Pole ON - OFF	6A	10A	16A	25A	32A	40A	63A	100A	200A	
61002	61192	61198	2 Pole ON - OFF	137	241	313	343	429	547	639	3359	4338	
61003*	-	-	3 Pole ON - OFF	175	275	357	422	499	660	818	4199	5652	
-	61199	61197		191	330	418	553	615	772	1107	5169	7059	
61004	61194	61196	4 Pole ON - OFF	191	330	446	672	718	872	1315	5987	8393	

* Motor Duty Switch (AC-3 Duty)

Offered upto 12 Pole

ROTARY SWITCHES



Changeover Switches (Local - Remote / Auto - Manual Switches)



60° With Center OFF	90° With Center OFF	90° Without OFF with Complete Rotation	Description	M.R.P. (₹) Per Unit									
				Cat. No.									
61025	61151	61037	1 P 2W	6A	10A	16A	25A	32A	40A	63A	100A	200A	
61026	61152	61038	2 P 2W	175	303	393	429	479	639	865	4338	6273	
61027	61153	61039	3 P 2W	235	366	446	579	672	878	1315	6350	9559	
61028	61154	61040	4 P 2W	289	454	597	872	942	1107	1767	8222	12232	
				357	529	688	1144	1206	1331	2215	10383	15269	



Phase Changeover (PS Series Switches)

Cat. No.	Description	M.R.P. (₹) Per Unit			
		25A	32A	40A	63A
61060	1 P 3W with OFF	392	489	714	803



Phase Changeover SS enclosure

Cat. No.	Description	M.R.P. (₹) Per Unit			
		25A	32A	40A	63A
72347PXM17TDYR	PS Series Switches in SS enclosure	2747	2893	4278	4380

Note: Prices are available on request for higher than 4 Pole ON-OFF version. Please contact nearest L&T branch office for prices.

Rotary Switches

Spring Return Switches



ON - OFF Spring Return Switches



Description	Cat. No.	M.R.P. (₹) Per Unit	
		16A	25A
1 P ON - OFF	61351	674	1042
2 P ON - OFF	61352	705	1179
3 P ON - OFF	61353	801	1410
4 P ON - OFF	61354	945	1539

Double Throw with Spring Return Switches



Description	Cat. No.	M.R.P. (₹) Per Unit	
		16A	25A
1 P 2W W/OFF Spring Return	61361	705	1179
2 P 2W W/OFF Spring Return	61362	1038	1539
3 P 2W W/OFF Spring Return	61363	1134	1918

One Side Spring Return Switches



Description	Cat. No.	M.R.P. (₹) Per Unit	
		16A	25A
1 P 3W Spring Return - OFF from 1	61364	643	1179
2 P 3W Spring Return - OFF from 1	61365	945	1539
3 P 3W Spring Return - OFF from 1	61369	1029	1918

Spring Return Switches without OFF



Description	Cat. No.	M.R.P. (₹) Per Unit	
		16A	25A
1 P 2W Spring Return - from 2 to 1	61371	643	1179
2 P 2W Spring Return - from 2 to 1	61372	945	1539
3 P 2W Spring Return - from 2 to 1	61373	1029	1918

Start Stop Spring Return Switches



Description	Cat. No.	M.R.P. (₹) Per Unit	
		16A	25A
1 P Start Stop Spring Return	61300	801	1190
2 P Start Stop Spring Return	61388	945	1539



Multi Step Switches

Multi Step Switches with OFF



3 Way

Description	Cat. No.	M.R.P. (₹) Per Unit								
		6A	10A	16A	25A	32A	40A	63A	100A	200A
1 P 3W	61060	207	345	411	PS Series Switches (Refer page no. 1)				4407	6694
2 P 3W	61080	289	405	500	686	742	1066	1200	6482	10236
3 P 3W	61100	418	543	847	1022	1113	1424	1852	8464	13439
4 P 3W	61131	531	695	1029	1276	1400	1905	2224	10693	16850



4 Way

1 P 4W	61061	242	310	597	725	802	913	1237	***	***
2 P 4W	61081	418	583	705	765	887	***	1447	***	***
3 P 4W	61101	575	***	1121	1276	1465	***	2224	15654	20212
4 P 4W	61132	696	1090	1423	1532	1635	2160	2566	21962	***



5 Way

1 P 5W	61062	265	495	688	903	918	***	1324	***	***
2 P 5W	61082	484	762	917	1231	1447	1485	1858	***	***
3 P 5W	61102	643	1398	1588	1743	***	2148	2514	20836	***



6 Way

1 P 6W	61063	350	***	666	***	935	967	***	***	***
2 P 6W	61083	575	***	969	***	***	***	***	***	***
3 P 6W	61103	810	***	1828	2053	***	***	2589	***	***



7 Way

1 P 7W	61064	357	571	720	918	960	997	1549	***	***
2 P 7W	61084	603	***	952	1439	***	2123	2458	***	***
3 P 7W	61104	832	***	1541	1890	***	2894	3406	***	***



8 Way

1 P 8W	61065	403	***	713	1260	***	1579	***	***	***
2 P 8W	61085	660	***	1300	***	***	***	***	***	***



9 Way

1 P 9W	61066	418	***	***	***	***	***	***	***	***
2 P 9W	61086	750	***	1904	***	***	***	***	***	***



10 Way

1 P 10W	61067	484	***	992	***	***	***	***	***	***
2 P 10W	61087	773	***	***	***	***	***	***	***	***



11 Way

1 P 11W	61068	575	***	907	2347	***	***	***	***	***
2 P 11W	61088	878	***	***	***	***	***	***	***	***

*** Prices are available on request.

Rotary Switches

Multi Step Switches without OFF



3 Way

Description	Cat. No.	M.R.P. (₹) Per Unit									
		6A	10A	16A	25A	32A	40A	63A	100A	200A	
1 P 3W W/O OFF	61049	196	332	420	529	553	849	960	***	***	
2 P 3W W/O OFF	61069	289	502	585	700	***	1066	1260	6482	***	
3 P 3W W/O OFF	61089	418	624	878	1022	1113	***	1852	***	13566	
4 P 3W W/O OFF	61120	531	695	1014	1299	1383	3039	3351	***	***	



4 Way

1 P 4W W/O OFF	61050	222	358	507	639	672	928	1291	4407	***
2 P 4W W/O OFF	61070	326	521	597	755	825	1113	1447	6811	10999
3 P 4W W/O OFF	61090	441	509	952	1206	1331	1458	1945	8970	14828
4 P 4W W/O OFF	61121	615	695	1111	1458	1549	1954	2597	11020	18762



5 Way

1 P 5W W/O OFF	61051	265	375	547	718	***	***	***	***	***
2 P 5W W/O OFF	61071	484	***	762	***	***	***	***	***	13934
3 P 5W W/O OFF	61091	643	***	1449	1579	***	1835	2589	***	***



6 Way

1 P 6W W/O OFF	61052	282	***	683	801	918	1073	1355	6482	12685
2 P 6W W/O OFF	61072	561	***	922	1430	1471	1485	1898	12917	16600
3 P 6W W/O OFF	61092	683	1310	1565	1707	1770	1937	2589	21962	34722



7 Way

1 P 7W W/O OFF	61053	350	***	***	950	***	***	***	11425	***
2 P 7W W/O OFF	61073	603	***	1029	1458	***	***	***	***	***
3 P 7W W/O OFF	61093	832	***	1701	2205	***	***	3485	***	***



8 Way

1 P 8W W/O OFF	61054	357	679	773	960	1011	1120	1635	***	***
2 P 8W W/O OFF	61074	636	***	1300	1521	***	***	***	***	***
3 P 8W W/O OFF	61094	894	***	1857	1984	2021	2318	3659	***	***



9 Way

1 P 9W W/O OFF	61055	418	***	1232	***	***	***	***	***	***
2 P 9W W/O OFF	61075	705	***	1171	***	***	***	***	***	***



10 Way

1 P 10W W/O OFF	61056	446	720	1368	***	***	***	***	***	***
2 P 10W W/O OFF	61076	780	***	***	***	***	***	***	***	***



11 Way

1 P 11W W/O OFF	61057	825	***	***	***	***	***	***	***	***
2 P 11W W/O OFF	61077	945	***	***	***	***	***	***	***	***



12 Way

1 P 12W W/O OFF	61058	872	***	1014	2425	2583	***	***	***	***
2 P 12W W/O OFF	61078	1022	***	***	***	***	***	***	***	***

*** Prices are available on request.

Instrumentation Selector Switches

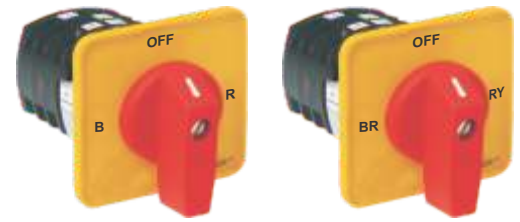

ROTARY SWITCHES

Ammeter Selector Switches (ASS)

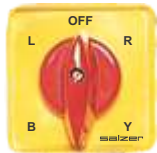

Description	Cat. No.	Amps	M.R.P. (₹) Per Unit
Line Currents with OFF with CT	61325 SAB13TDYR	6A	291
Line Currents with OFF with CT	61325 SBB13TDYR	10A	321
Line Currents with OFF with CT	61325 SCB03TDYR	16A	442
Line Currents with OFF without CT	71000 SCB03TDYR	16A	1268
Direct Currents with OFF without CT	71000 SEB03TDYR	25A	1458
Direct Currents with OFF without CT	71000 SFB03TDYR	32A	1750
Direct Currents with OFF without CT	71000 SGB03TDYR	40A	3075
Direct Currents with OFF without CT	71000 SIB03TDYR	63A	3243

Voltmeter Selector Switches (VSS)



Description	Cat. No.	Amps	M.R.P. (₹) Per Unit
Voltage between Phases with OFF	61312 SAB13TDYR	6A	211
Voltage between Phases with OFF	61312 SBB13TDYR	10A	292
Voltage between Phases with OFF	61312 SCB03TDYR	16A	399

Description	Cat. No.	Amps	M.R.P. (₹) Per Unit
Voltage between Phases & Individual Phases to Neutral with OFF	61313 SAB13TDYR	6A	375
Voltage between Phases & Individual Phases to Neutral with OFF	61313 SBB13TDYR	10A	584
Voltage between Phases & Individual Phases to Neutral with OFF	61313 SCB03TDYR	16A	749

Description	Cat. No.	Amps	M.R.P. (₹) Per Unit
Voltage between Phase & Phase to Neutral without OFF	61314 SBB13TDYR	10A	576

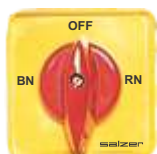

Description	Cat. No.	Amps	M.R.P. (₹) Per Unit
Voltage between Phases & Phase to Neutral without OFF	61311 SAB13TDYR	6A	375
Voltage between Phases & Phase to Neutral with OFF	61311 SBB13TDYR	10A	395

Ammeter & Voltmeter Combined Switch



Description	Cat. No.	Amps	M.R.P. (₹) Per Unit
Voltage between Phases to Neutral & Current of that Phase	61338 SBB13TDYR	10A	617

Rotary Switches

Motor Control Switches



61003



61211

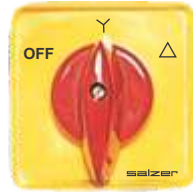

61200



61217

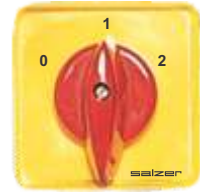

61212

Description	Cat. No.	M.R.P. (₹) Per Unit						
		16A	25A	32A	40A	63A	100A	200A
ON - OFF Switch	61003	642	795	884	1108	1593	5686	7410
FOR - OFF - REV Switch	61211	484	594	703	1831	2224	5667	9134
Star - Delta Switch	61200	643	836	1050	1603	2053	***	***
2 Speed for FOR - OFF - REV Switch	61217	***	1513*	***	2528	***	***	***
2 Speed forward Switch	61212	705	1378	1727	2170	2660	7087	8184

Supplied only with ball grip handle

Switches in Enclosure



73393, 71913



72244



Description	Cat. No.	Amps	M.R.P.
FOR - OFF - Rev in SS with ball grip handle	73393SCM17BGXB	16A	540
FOR - OFF - Rev in SS with ball grip handle	71913SEM17BGYR	25A	826
FOR - OFF - Rev in SS with ball grip handle	71913SFM17BGYR	32A	1214
3 Pole ON - OFF in SS	72244SEM17TDYR	25A	718
3 Pole ON - OFF in SS	72244SFM17TDYR	32A	1047
3 Pole 2Way Without OFF in SS	61153SCM17TDYR	16A	986

For any other rating requirement please contact nearest L&T branch office

Breaker Control Switches (Trip - Neutral - Close)



Rating	Contact Arrangement	Mounting Type	Cat. No.	M.R.P. (₹) Per Unit
25A	1NO + 1NC	Standard	73257SEB03PGYR	1117
25A	1NO + 1NC	Standard	73257SEB03PGGB	1117
25A	1NO + 1NC	Barrel Lock	73257SEB90PGBB	1548
25A	2NO + 2NC	Standard	72009SEB03PGYR	1315
25A	2NO + 2NC	Standard	72009SEB03PGBB	1315
25A	2NO + 2NC	Standard	72009SEB03PGGB	1315
25A	2NO + 2NC	Barrel Lock	72009SEB90PGBB	1876

Other option such as sequence inter lock (SIL) & lost motion device (LMD) available on request.

Accessories (8538)

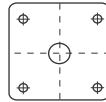

Front Plate Assembly

Description	Cat. No.	Size	M.R.P. (₹) Per Unit
Front Plate for 6 to 16A	FP16SQ48	48 x 48	29
Front Plate for 25 & 32A	FP32SQ64	64 x 64	51
Front Plate for 40 to 200A	FP200SQ88	88 x 88	83

Knobs & Handles



Tear Drop



Flag Handle



Ball Grip



Lever Handle

Description	Cat. No.	Size	M.R.P. (₹) Per Unit
Flag Handle for 16A	KNFHS2	48 x 48, 48 x 60	18
Flag Handle for 25 - 32A	KNFHS3	64 x 64, 64 x 80	30
Tear Drop for 6 - 16A	KNTDS1	48 x 48, 48 x 60	18
Tear Drop for 16 - 32A	KNTDS2	64 x 64, 64 x 80	30
Tear Drop for 40 - 400A	KNTDS3	88 x 88, 104 x 104	60
Ball Handle for 16 - 32A	HNBSH1	64 x 64, 64 x 80	75
Ball Handle for 40 - 63A	HNBSH2	88 x 88, 104 x 104	83
PG Handle for 16 - 32A	HNPGS1	64 x 64, 64 x 80	88
Lever Handle for 40 - 200A	HNLVS1	88 x 88, 104 x 104	111

Script Plate - Silver Finish

(For Black Front Plate Assembly only)

Description	Cat. No.	Size	M.R.P. (₹) Per Unit
Silver Finish 48 x 48 mm	SFSQ48	48 x 48	18
Silver Finish 64 x 64 mm	SFSQ64	64 x 64	20
Silver Finish 88 x 88 mm	SFSQ88	88 x 88	26
Silver Finish 104 x 104 mm	SFSQ104	104 x 104	45

Wall Type Mounting Boxes

(upto 32A - maximum 4 Contacts)

Description	Cat. No.	M.R.P. (₹) Per Unit
Plastic / ABS Enclosure B17 16A upto 3 Stage / 25A / 32A upto 2 Stage (SM Box)	WMBABSS	522
Aluminium Enclosure B17 16A upto 3 Stage / 25A upto 2 Stage	WMBAL	869
SS Enclosure M17 16A - 32A upto 4 Stage	WMBSS	342

Note: Switches to be ordered separately.

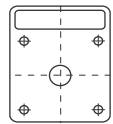

Special Front Plate Assembly

Description	Cat. No.	Size	M.R.P. (₹) Per Unit
SPL IND Plates upto 16A	FPRT4860	48 x 60	51
SPL IND Plates for 16 - 32A	FPRT6480	64 x 80	88

Script Plate (marking plate)

Description	Cat. No.	Size	M.R.P. (₹) Per Unit
Script Plate for 6 - 16A	SPSQ48	48 x 48	18
Script Plate for 16 - 32A	SPSQ64	64 x 64	20
Script Plate for 40 - 200A	SPSQ88	88 x 88	26
Script Plate for 6 - 16A	SPRT4816	48 x 16	8
Script Plate for 6 - 32A	SPRT6416	64 x 16	8

Mounting Plates

(used for Back Fixing Plate)

Description	Cat. No.	Size	M.R.P. (₹) Per Unit
Rear MTG Plate for 6 - 16A	MPSQ48	48 x 48	13
Rear MTG Plate for 25 - 32A	MPSQ64	64 x 64	20
Rear MTG Plate for 40 - 63A	MPSQ88	88 x 88	46
Rear MTG Plate for 80 - 400A	MPSQ104	104 x 104	88
DIN Rail Attachment upto 32A	B21DIN35	-	82

Shrouding Cover

(Maximum 6 Contacts Round Type)

Description	Cat. No.	M.R.P. (₹) Per Unit
Shrouding Cover for 6 - 10A	SHCS1	56
Shrouding Cover for 16A	SHCS2	56
Shrouding Cover for 25 - 32A	SHCS3	87
Shrouding Cover for 40 - 63A	SHCS4	91
Special Cover for Extended Termination 80 - 400A (maximum 2 Contact Stage)	SHCS5	667



B31 ABS Enclosure

Rotary Switches

Ordering Code for Rotary Switches

Example for : 1. Programme Code | 2. Type | 3. Ampere | 4. Mounting | 5. Knob | 6. Colour

25A 3 Pole 6 | 1 | 1 | 9 | 7 | S | E | B | 0 | 3 | T | D | Y | R

ON - OFF Switch

1. Programme Code

Programme	Programme Code
Isolators	Pg 1
Changeovers Switches	Pg 1
Spring Return Switches	Pg 2
Multistep Switches with OFF	Pg 3
Multistep Switches without OFF	Pg 4
Instrumentation Switches	Pg 5
Motor Control Switches	Pg 6
Switches in SS Enclosure	Pg 6
Breaker Control Switches	Pg 6

2. Type Selection

Type	Code
S-Series (6 to 400A)	S
Touch Proof (6 to 16A)	T
Rear Access Termination (16 to 63A)	R
Phase Selector Only for 1 Pole 3 Way with OFF (25 to 63A)	P
DC Switches (16 to 500A)	D



S Series
Open Version



TP Series
Touch Proof



Touch Proof & RT Series
Rear Termination

3. Ampere Selection

Ampere	Code	Ampere	Code
6	A	100	K
10	B	125	L
16	C	160	M
20	D	200	N
25	E	250	O
32	F	300	P
40	G	400	Q
50	H	500	R
63	I	600	S
80	J	800	T

4. Mounting Style



B03/B13
Standard Mounting



B19/B14
Single Hole Mounting



B33
Round Padlock



B30
Rectangular Padlock



B63
Key Lockable Type



B90
Key Lockable Type



B53
Key Lockable Type



B17
ABS Enclosure



M17
Metal Enclosure



B02
Rear/Base Mounting



B21
DIN Rail Mounting



B42
Rear Mounting with
Door Interlock

5. Knob / Handle Selection

Code - TD

Tear Drop

Code - FH

Flag Knob

Code - PG

Pistol Grip

Code - BG

Ball Grip

Code - LV

Lever Handle

6. Color Combination Selection Table

Code - YR

Yellow Front Plate
Red Knob

Code - GB

Grey Front Plate
Black Knob





Code - BB

Black Front Plate
Black Knob

Code - AB

Aluminum Foil with
Black Knob

Front Plate

Standard Style	Frame Size	Bigger Style
Current Ratings 6/10 Amps		Current Ratings ---
16/20 Amps		6/10 Amps
25/32 Amps		16/20 Amps
S40 Amps & above		25/32 Amps
—		S40 Amps & above

Note: 1. For ratings of 6/10A, standard mounting style is B13
2. Single hole mounting equivalent of B03 is B19 and B13 is B14.

Mounting Feasibility

Mounting Code	Description	Feasibility					
		6/10A	16/20A	25/32A	40/63A	80/100/125A	200/400A
B03	Front Mounting, Standard Mounting plate		✓	✓	✓	✓	✓
B13	Front Mounting with next size plate	✓	✓	✓	✓	✓	✓
B00	Front Mounting 48 x 48 plate for 25/32 A and 64 x 64 plate for 40/63A			✓	✓		
B19	Single Hole Mounting 32 x 32 plate for 6/10A only 48 x 48 Plate for 16-32A	✓	✓	✓			
B14	Single Hole Mounting 48 x 48 plate for 6/10A	✓					
B33	Front Mounting with Round Padlock for 2 Position (for Isolators)		✓	✓	✓	✓	✓
B30	Front Mounting with Rectangular Padlock 2 Position (for Isolators)		✓	✓	✓	✓	✓
B63	Key Lockable type (Handle/Knob)		✓	✓	✓		
B90	Center Key Lock (Pistol grip Handle in black color only)		✓	✓			
B02	Rear / (Back/Base) Mounting	✓	✓	✓	✓	✓	✓
B21	DIN Rail Mounting on 35 mm Rail 6-32 Amps	✓	✓	✓			
B32	Rear / Base Mounting, Door Interlock + Rectangular Padlock (B30+B42)		✓	✓	✓	✓	✓
B34	Rear / Base Mounting, Door Interlock + Round Padlock (B33+B42)		✓	✓	✓	✓	✓
B41	Rear Mounting with Clutch Mechanism on Door (Door Open in all position without Interlock)		✓	✓	✓	✓	✓
B42	Rear Mounting with Interlock Mechanism on Door		✓	✓	✓	✓	✓
F47	Door Clutch, Mounting Plate at front		✓	✓	✓	✓	✓
B17	ABS Enclosure	upto 4	upto 4	upto 4	upto 2		
B31	ABS Enclosure with Round Padlock (B33+B17)	Max stages	upto 2	upto 2	upto 2		
M17	Metal Enclosure	Max stages	upto 4	upto 4			✓
A17	Aluminium Enclosure	Max stages	upto 3	upto 2			
B40	Single Hole Mounting with Padlock 48 x 48 Plate For 16-32A		✓	✓			
B43	Single Hole Mounting with Center key 48 x 48 Plate for 16-32A		✓	✓			
B45	Single Hole Mounting with Round Ring with Knob 16A-32A		✓	✓			

Single Hole Mounting Rotary Switch

Single hole mounting (SHM) range of rotary switches uses a unique mounting concept that requires just a single $\Phi 22.5$ cutout to mount the switches on the panel. These help in reducing the time and cost during assembly.

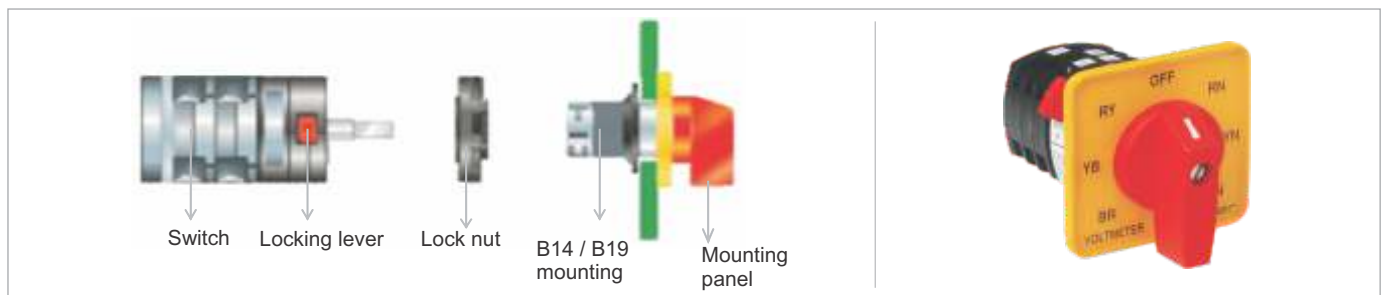

Benefits:

- **Single hole panel cutout** – makes easier for fitting on the panel
- **Easy mounting** – reduces assembly time by 50% over conventional 5 hole mounting
- **Wiring accessibility** – reduces wiring time, the switch can be wired separately and then snap fitted to the mounting assembly using the locking lever.

There is no additional price for switches with Single hole mounting from standard mounting.

DC Switches

- Available from 16A to 500A
- Used for railway coaches lighting & fan circuits switching, all DC power circuits - Railways, Telecommunications & Power plants, Battery charging equipment
- Please contact nearest branch office for prices



Load Break Switches

AC ON LOAD ISOLATORS (8536)

- AC23 Utilization Category



B03



MB34



B31SM

LB 3 Pole ON - OFF Switches

Description	Cat. No.	Can also be given on request	M.R.P. (₹) Per Unit								
			16A	20A	25A	32A	40A	63A	80A	100A	125A
Single Hole MTG Switch with Flag Knob	LBX32300B19FPYR		635	649	*	*	*	*	*	*	*
Front Plate MTG with Flag Knob	LBX32300B40FPYR		618	635	*	*	*	*	*	*	*
Front Panel MTG with B03 (48x48) Plate	LBX32300B03FLYR	32309	565	578	627	649	744	799	*	*	*
Front Panel MTG with B13 (64x64) Plate with Flag Knob	LBX32300B13FLYR	32306 / 32309	565	578	627	649	744	799	2021	2536	3185
Front Panel MTG with B13 (64x64) Plate with BG Handle	LBX32300B13BGYR	32309	*	*	688	712	806	852	*	*	*
DIN Rail MTG Switch with Flag Knob	LBX32300B23FLGB		*	*	627	649	744	799	*	*	*
Rectangular Pad Lock Switch with TDYR	LBX32300B30TDYR		*	*	758	799	876	922	*	*	*
Round Pad Lock Switch with RDYR	LBX32309B33RDYR		618	634	688	712	806	852	2191	2735	3419
Switch with B63 Lock & Key Version	LBX32309B63TDYR		*	*	1048	1095	1187	1219	*	*	*
Base MTG Switch with DIL and Pad Lock	LBX32309MB34RDYR		986	1017	1095	1155	1203	1296	2920	3645	4558
Base MTG Switch with BG Handle	LBX32309MB42BGYR		986	1017	1095	1155	1203	1296	2920	3645	4558
Switch in ABS Enclosure - in B31SM	LBX32300B31SMRDYR		1251	1290	1392	1429	*	*	*	*	*
Switch in ABS Enclosure - in B31M	LBX32309B31MRDYR		*	*	*	*	1562	1601	*	*	*
Switch in ABS Enclosure - in B31L with Leech Handle	LBX32309B31LLHYR		*	*	*	*	*	*	4112	4847	5751
Switch in SS Enclosure - in SB31L with Leech Handle	LBX32309SB31LLHYR		*	*	*	*	*	*	4112	4847	5751

LB 4 Pole ON - OFF Switches

Description	Cat. No.	Can also be given on request	M.R.P. (₹) Per Unit								
			16A	20A	25A	32A	40A	63A	80A	100A	125A
Single Hole MTG Switch with Flag Knob	LBX32400B19FPYR		790	806	*	*	*	*	*	*	*
Front Plate MTG with Flag Knob	LBX32400B40FPYR		775	790	*	*	*	*	*	*	*
Front Panel MTG with B03 (48x48) Plate	LBX32400B03FLYR	32409	720	736	800	821	962	1017	*	*	*
Front Panel MTG with B13 (64x64) Plate with Flag Knob	LBX32400B13FLYR	32406 / 32409	720	736	800	821	962	1017	2481	3113	3901
Front Panel MTG with B13 (64x64) Plate with BG Handle	LBX32400B13BGYR	32409	*	*	861	885	1025	1071	*	*	*
DIN Rail MTG Switch with Flag Knob	LBX32400B23FLGB		*	*	800	821	962	1017	*	*	*
Rectangular Pad Lock Switch with TDYR	LBX32400B30TDYR		*	*	930	970	1095	1141	*	*	*
Round Pad Lock Switch with RDYR	LBX32409B33RDYR		775	790	861	885	1025	1071	2536	3167	3958
Switch with B63 Lock & Key Version	LBX32409B63TDYR		*	*	1219	1267	1405	1437	*	*	*
Base MTG Switch with DIL and Pad Lock	LBX32409MB34RDYR		1141	1172	1267	1327	1423	1516	3381	4222	5275
Base MTG Switch with BG Handle	LBX32409MB42BGYR		1141	1172	1267	1327	1423	1516	3381	4222	5275
Switch in ABS Enclosure - in B31SM	LBX32400B31SMRDYR		1405	1446	1562	1601	*	*	*	*	*
Switch in ABS Enclosure - in B31M	LBX32409B31MRDYR		*	*	*	*	1780	1820	*	*	*
Switch in ABS Enclosure - in B31L with Leech Handle	LBX32409B31LLHYR		*	*	*	*	*	*	4574	5423	6471
Switch in SS Enclosure - in SB31L with Leech Handle	LBX32409SB31LLHYR		*	*	*	*	*	*	4574	5423	6471
Auxiliary Contact	FM / RM		159	159	193	193	193	193	578	578	578
Add-on Contact Additional Pole	FM / RM		162	170	182	204	238	257	675	841	928

EB - GEN Changeover Switches (8536)



B13 Mounting



MB42 Mounting



SB31 Enclosure

3 Pole EB - GEN Changeover Switches

Description	Cat. No.	M.R.P. (₹) Per Unit						
		25A	32A	40A	63A	80A	100A	125A
3 Pole C/O Front Panel Mounting	EBX31153B13BGYR	1852	1929	2250	2341	*	*	*
3 Pole C/O Rear Mounting	EBX31153MB42BGYR	2148	2226	2591	2671	4777	5977	7467
3 Pole C/O in SS Enclosure	EBX31153SB31BGYR	2569	2639	3054	3145	*	*	*
3 Pole C/O Rear Mounting	EBX31153B21BGYR	2148	2226	2591	2671	4777	5977	7467
3 Pole C/O Rear Mounting	EBX31153MB34LHGB	2148	2226	2591	2671	4777	5977	7467
3 Pole C/O in ABS Enclosure	EBX31153B31LBGYR	2569	2639	3054	3145	*	*	*
3 Pole C/O in SS Enclosure	EBX31153SB31XLLHYR	*	*	*	*	6751	7943	9432

4 Pole EB - GEN Changeover Switches

Description	Cat. No.	M.R.P. (₹) Per Unit						
		25A	32A	40A	63A	80A	100A	125A
4 Pole C/O Front Panel Mounting	EBX31154B13BGYR	2148	2226	2639	2716	*	*	*
4 Pole C/O Rear Mounting	EBX31154MB42BGYR	2420	2513	2967	3090	6025	7539	9418
4 Pole C/O in SS Enclosure	EBX31154SB31BGYR	2864	2975	3451	3574	*	*	*
4 Pole C/O Rear Mounting	EBX31154B21BGYR	2420	2513	2967	3090	6025	7539	9418
4 Pole C/O Rear Mounting	EBX31154MB34LHGB	2420	2513	2967	3090	6025	7539	9418
4 Pole C/O in ABS Enclosure	EBX31154B31LBGYR	2864	2975	3451	3574	*	*	*
4 Pole C/O in SS Enclosure	EBX31154SB31XLLHYR	*	*	*	*	7999	9502	11391

Ordering Code for Load Break and Changeover Switches

LB Load Break Switch	EB EB Changeover Switch	X Current Rating	XXXXXX Programme Code	XXXXXX Mounting Options	XX Knob Options	XX Colour
------------------------------	---	--------------------------	-------------------------------	---------------------------------	-------------------------	-------------------

Example

LB Switches, 63A, 3P, 9 O'clock, 4 hole front mounting, with metal shaft, yellow front plate, red round knob

LB I 32309 MB34 RDYR

LB	I	32309	MB34	RD	YR	Description
—	—	—	—	—	—	Yellow Front Plate/Red Knob
—	—	—	—	—	—	64 x 64 Front Plate Round Knob with Padlock (R)
—	—	—	—	—	—	Metal Shaft with Round Knob with Padlock and Interlock
—	—	—	—	—	—	3Pole 9 O' Clock "OFF"
—	—	—	—	—	—	63A
—	—	—	—	—	—	Load Break Switch

Accessories

X F-Front Mounting	XX MC-Main Module	X 20 - 16A to 20A 32 - 25A to 32A 63 - 40A to 63A 80 - 80A 125 - 100A, 125A & 80A
R-Rear Mounting	NC-Neutral Module	AC-Auxiliary Module

R	NC	32	Description
—	—	—	32A
—	—	—	Neutral Module
—	—	—	Rear Mounting

Rating Selection Table

Ampere (A)	16	20	25	32	40	63	80	100	125
Code (X)	C	D	E	F	G	I	J	K	L

Note : SB31 Enclosure for 25A to 63A ratings, SB31XL Enclosure for 80A to 125A ratings B21 Mounting model is similar to B13 model with links provided on the common side.

*Note : Not able to offer

DC CHANGEOVER

Application - I

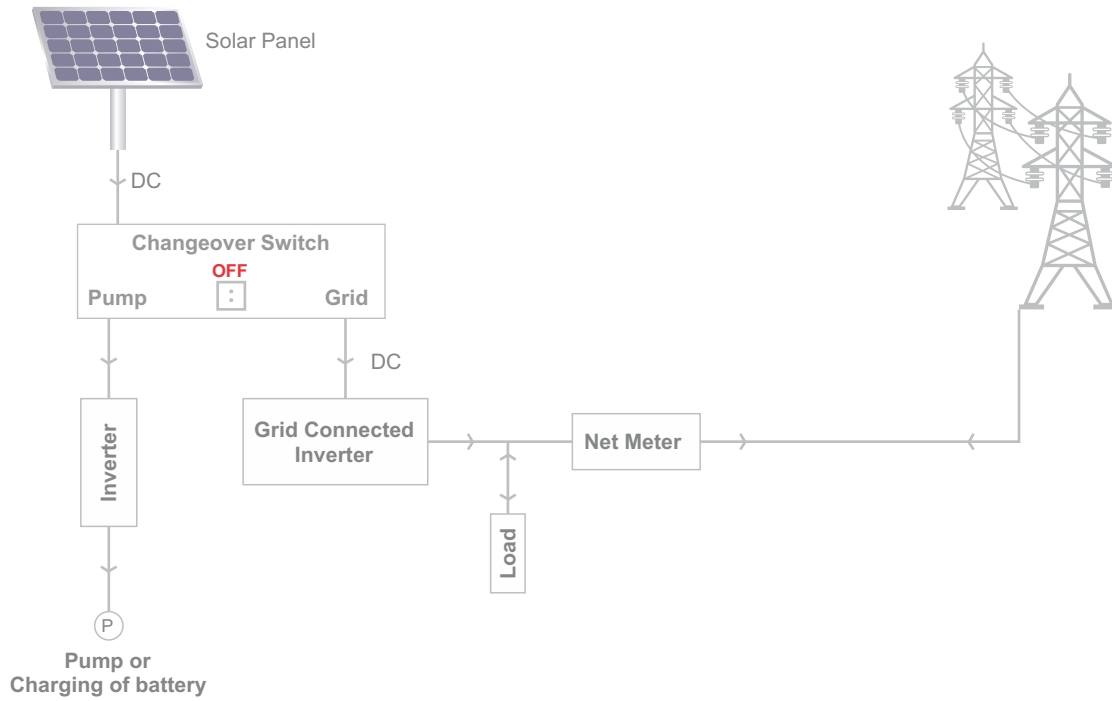

Application - II

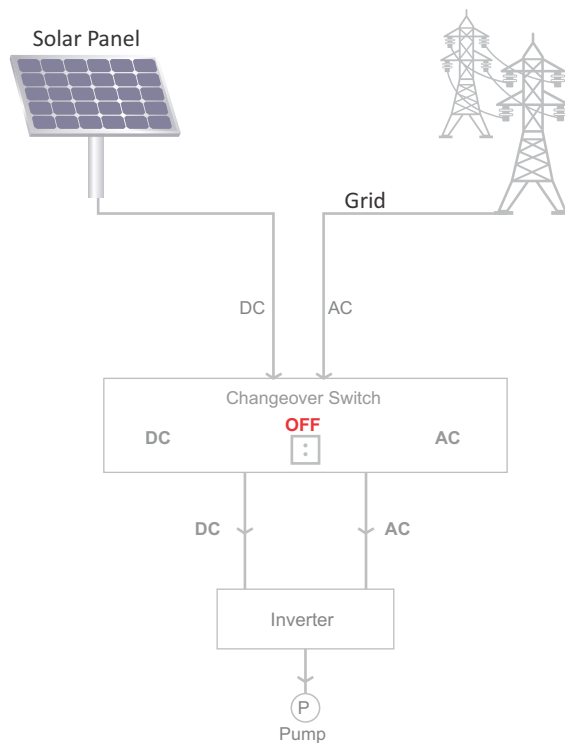

DC ISOLATORS



AC/DC CHANGEOVER



Description	Cat. No.	AMPS Rating	M.R.P. (₹) Per Unit
		DC21B (Amps)	
	4 POLE ISOLATOR	AMPS Rating @ 1000V DC	
Front MTG Switch with Flag Knob	DC LB216 30409 B13 FLGB	20	1494
	DC LB225 30409 B13 FLGB	25	1699
	DC LB232 30409 B13 FLGB	40	1806
Front MTG Switch with Round Knob, Pad Lock	DC LB216 30409 B33 RDGB	20	1601
	DC LB225 30409 B33 RDGB	25	1806
	DC LB232 30409 B33 RDGB	40	1911
DIN Rail MTG Switch with Flag Knob	DC LB216 30409 B23 FLGB	20	1494
	DC LB225 30409 B23 FLGB	25	1699
	DC LB232 30409 B23 FLGB	40	1806
DIN Rail MTG Switch with Flag Knob, DB Mounting	DC LB216 30409 B23P FLBB	16	1547
	DC LB225 30409 B23P FLBB	25	1752
	DC LB232 30409 B23P FLBB	40	1858
	DC LB216 30409 B23DBP FLBB	16	1531
	DC LB225 30409 B23DBP FLBB	25	1733
	DC LB232 30409 B23DBP FLBB	40	1841
Base MTG Switch with DIL and Pad Lock	DC LB216 30409 MB34 RDGB	16	1601
	DC LB225 30409 MB34 RDGB	25	1806
	DC LB232 30409 MB34 RDGB	40	1911
In Plastic Enclosure	DC LB216 30409 SMX RDGB	16	1778
	DC LB225 30409 SMX RDGB	25	1983
	DC LB232 30409 SMX RDGB	40	2089
	8 POLE ISOLATOR	AMPS Rating @ 1000V DC	
DIN Rail MTG Switch with Ball Grip Handle	DC LB216 30809 B21 BGGB	16	2845
	DC LB225 30809 B21 BGGB	25	3111
	DC LB232 30809 B21 BGGB	40	3759
Base MTG Switch, DIL & Pad Lock with Leech Handle	DC LB216 30809 MB34 LHGB	16	3049
	DC LB225 30809 MB34 LHGB	25	3316
	DC LB232 30809 MB34 LHGB	40	3964
In Plastic Enclosure	DC LB216 30809 B31L SHGB	16	4315
	DC LB225 30809 B31L SHGB	25	4582
	DC LB232 30809 B31L SHGB	40	5230
	4 POLE CHANGEOVER	AMPS Rating @ 1000V DC	
DIN Rail MTG Switch with Ball Grip Handle	DC LB216 30154 B21 BGGB	16	2845
	DC LB225 30154 B21 BGGB	25	3111
	DC LB232 30154 B21 BGGB	40	3759
Base MTG Switch, DIL & Pad Lock with Leech Handle	DC LB216 30154 MB34 LHGB	16	3049
	DC LB225 30154 MB34 LHGB	25	3316
	DC LB232 30154 MB34 LHGB	40	3964
In Plastic Enclosure	DC LB216 30154 B31L SHGB	16	4315
	DC LB225 30154 B31L SHGB	25	4582
	DC LB232 30154 B31L SHGB	40	5230

* Note : 2 Pole Isolators can also be supplied on request / 63 Amps Rating also available

FRLS Cable Ducts (8538)

The flammability and smoke performance of rigid PVC (RPVC) plays a significant role in its selection for wiring duct applications. One of the most serious problems of general RPVC cable duct combustion is that it produces large volume of smoke and toxic gases which became the main cause of fire related death. Apart from the irritant effect of HCl gas on the eyes and respiratory system, smoke can cause disorientation and hinder escape from the scene of the fire; which impedes the entry of fire fighters. Hence, the reduction of smoke emissions is clearly desirable.

Salzer FRLS PVC Cable Ducts efficiently carries and protects wires and cables, which are manufactured from specially compounded, low smoke, flame retarded and high impact rigid polyvinyl chloride (RPVC) resin. We modified RPVC wiring duct formulations and used low doses of plasticizer and lubricants to get higher limiting oxygen index (LOI) and low smoke density rating (SDR) with excellent flame retardant (V-0) characteristics. Our wiring duct offers an effective resistance against fire propagation and emits very negligible amount of smokes during fire catching. Salzer cable duct has a flammability rating of V-0, REACH and RoHS compliant and has a continuous use temperature up to 140°F (60 °C). Wide range of colour, sizes and different slotting styles to meet the customer requirements.

Type A	Description		1 Meter				2 Meter			
	H x W	Cat. No.(Standard slot Grey)	M.R.P. (₹) Per	Std. Pkg.	Min Order Qty	Cat. No.(Standard slot Grey)	M.R.P. (₹) Per Unit	Std. Pkg.	Min Order Qty	
	A 15 x 15	WWA1515SG	55	100	100	WWA1515SG2	110	64	64	
	A 15 x 25	WWA1525SG	76	100	100	WWA1525SG2	152	64	64	
	A 25 x 25	WWA2525SG	92	70	70	WWA2525SG2	184	48	48	
	A 30 x 25	WWA3025SG	101	70	70	WWA3025SG2	202	48	48	
	A 40 x 30	WWA4030SG	127	75	75	WWA4030SG2	254	32	32	
	A 45 x 25	WWA4525SG	129	75	75	WWA4525SG2	258	40	40	
	A 45 x 30	WWA4530SG	130	50	50	WWA4530SG2	260	32	32	
	A 45 x 45	WWA4545SG	163	50	50	WWA4545SG2	326	18	18	
	A 45 x 60	WWA4560SG	198	50	50	WWA4560SG2	396	12	12	
	A 60 x 25	WWA6025SG	163	50	50	WWA6025SG2	326	18	18	
	A 60 x 45	WWA6045SG	193	50	50	WWA6045SG2	386	18	18	
	A 60 x 60	WWA6060SG	229	32	32	WWA6060SG2	458	12	12	
	A 60 x 120	WWA60120SG	780	18	90	WWA60120SG2	1560	8	80	
	A 75 x 45	WWA7545SG	240	40	40	WWA7545SG2	480	12	12	
	A 75 x 75	WWA7575SG	337	32	32	WWA7575SG2	674	12	12	
	A 80 x 80	WWA8080SG	379	25	25	WWA8080SG2	758	12	12	
	A 100 x 100	WWA100100SG	612	18	18	WWA100100SG2	1224	8	40	

cover for fast and efficient locking.

A Type

- * Snap fit cover
- * Easy to remove

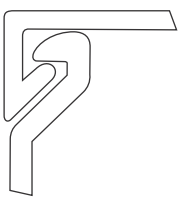
Type B	Description		1 Meter				2 Meter			
	W x H	Cat. No. (Standard slot)	M.R.P. (₹) Per Unit	Std. Pkg.	Min Order Qty	Cat. No. (Standard slot)	M.R.P. (₹) Per Unit	Std. Pkg.	Min Order Qty	
	B 25 x 25	WWB2525SG	95	70	100	WWB2525SG2	190	36	36	
	B 25 x 30	WWB2530SG	101	100	100	WWB2530SG2	202	36	36	
	B 25 x 40	WWB2540SG	125	75	75	WWB2540SG2	250	36	36	
	B 25 x 45	WWB2545SG	129	75	225	WWB2545SG2	258	36	108	
	B 25 x 60	WWB2560SG	163	50	50	WWB2560SG2	326	18	18	
	B 25 x 80	WWB2580SG	223	50	50	WWB2580SG2	446	18	18	
	B 25 x 100	WWB25100SG	283	25	25	WWB25100SG2	566	18	18	
	B 30 x 20	WWB3020UG	125	100	200	WWB3020UG2	250	36	180	
	B 30 x 80	WWB3080SG	343	50	200	WWB3080SG2	686	18	90	
	B 40 x 40	WWB4040SG	163	50	50	WWB4040SG2	326	18	18	
	B 45 x 45	WWB4545SG	169	50	50	WWB4545SG2	338	18	18	
	B 40 x 60	WWB4060SG	198	50	50	WWB4060SG2	396	18	18	
	B 40 x 80	WWB4080SG	235	50	50	WWB4080SG2	470	18	18	
	B 40 x 100	WWB40100SG	295	25	25	WWB40100SG2	590	12	12	
	B 45 x 20	WWB4520UG	130	75	225	WWB4520UG2	260	36	180	
	B 50 x 100	WWB50100SG	340	30	90	WWB50100SG2	680	12	60	
	B 60 x 20	WWB6020UG	178	50	200	WWB6020UG2	356	18	90	
	B 60 x 40	WWB6040SG	198	50	50	WWB6040SG2	396	18	90	
	B 60 x 60	WWB6060SG	235	50	50	WWB6060SG2	470	12	12	
	B 60 x 80	WWB6080SG	306	40	40	WWB6080SG2	612	12	12	
	B 60 x 100	WWB60100SG	403	30	30	WWB60100SG2	806	8	8	
	B 72 x 64	WWB7264SG	282	32	96	WWB7264SG2	564	18	90	
	B 75 x 75	WWB7575SG	399	32	96	WWB7575SG2	798	8	40	
	B 75 x 100	WWB75100SG	415	25	75	WWB75100SG2	830	8	40	
	B 80 x 40	WWB8040SG	240	50	100	WWB8040SG2	480	12	60	
	B 80 x 60	WWB8060SG	318	40	80	WWB8060SG2	636	12	60	
	B 80 x 80	WWB8080SG	396	32	32	WWB8080SG2	792	12	12	
	B 80 x 100	WWB80100SG	445	24	24	WWB80100SG2	890	8	8	
	B 100 x 60	WWB10060SG	379	30	30	WWB10060SG2	758	8	8	
	B 100 x 80	WWB10080SG	445	25	25	WWB10080SG2	890	8	8	
	B 100 x 100	WWB100100SG	648	18	18	WWB100100SG2	1296	8	8	
	B 120 x 80	WWB12080SG	631	18	90	WWB12080SG2	1262	8	40	
	B 150 x 100	WWB150100SG	810	12	48	WWB150100SG2	1620	4	40	
	B 150 x 150	WWB150150SG	1762	8	80	WWB150150SG2	3524	2	40	

Non slip cover design of minimum encumbrance and maximum grip

- * Non - slip cover
- * Positive locking

Note : 1) For any special colour request additional 10% will be charged on price. For cut length additional 10% will be charged. 2) Thin / Unslot will be supplied on request. For thin slot replace the cat. number ending with SG by TG, For un slotted channel replace the cat. number ending with SG by UG. MRP will be same as standard slot.

Type B	Description W x H	1 meter				2 meter			
		Cat. No. (Thin slot)	M.R.P. (₹) Per Unit	Std. Pkg.	Min Order Qty	Cat. No. (Thin slot)	M.R.P. (₹) Per Unit	Std. Pkg.	Min Order Qty
 Non slip cover design of minimum encumbrance and maximum grip B Type * Non - slip cover * Positive locking	B 25 x 30	WWB2530HG	293	100	100	WWB2530HG2	586	36	72
	B 25 x 40	WWB2540HG	373	75	150	WWB2540HG2	746	36	72
	B 25 x 60	WWB2560HG	502	50	100	WWB2560HG2	1004	18	54
	B 25 x 80	WWB2580HG	647	50	100	WWB2580HG2	1294	18	54
	B 25 x 100	WWB25100HG	794	25	100	WWB25100HG2	1588	18	54
	B 40 x 40	WWB4040HG	440	50	100	WWB4040HG2	880	18	54
	B 40 x 60	WWB4060HG	585	50	100	WWB4060HG2	1170	18	54
	B 40 x 80	WWB4080HG	710	50	100	WWB4080HG2	1420	18	54
	B 40 x 100	WWB40100HG	877	25	100	WWB40100HG2	1754	12	48
	B 60 x 40	WWB6040HG	564	50	100	WWB6040HG2	1128	18	54
	B 60 x 60	WWB6060HG	690	50	100	WWB6060HG2	1380	12	48
	B 60 x 80	WWB6080HG	960	40	120	WWB6080HG2	1920	12	48
	B 60 x 100	WWB60100HG	1107	30	90	WWB60100HG2	2214	8	48
	B 80 x 40	WWB8040HG	690	50	100	WWB8040HG2	1380	12	48
	B 80 x 60	WWB8060HG	919	40	120	WWB8060HG2	1838	12	48
	B 80 x 80	WWB8080HG	1107	32	96	WWB8080HG2	2214	12	48
	B 80 x 100	WWB80100HG	1211	24	96	WWB80100HG2	2422	8	48
	B 100 x 60	WWB10060HG	1065	30	90	WWB10060HG2	2130	8	48
	B 100 x 80	WWB10080HG	1336	25	100	WWB10080HG2	2672	8	48
	B 100 x 100	WWB100100HG	1607	18	90	WWB100100HG2	3214	8	48

* Under development

Slotting Styles (A & B Types)

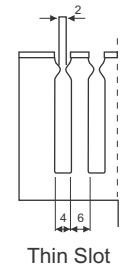
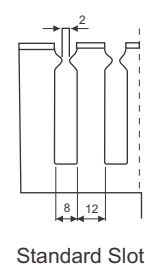
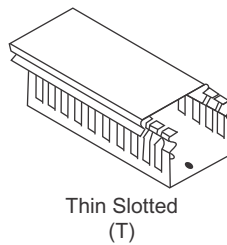
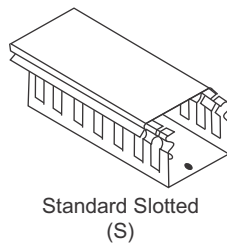
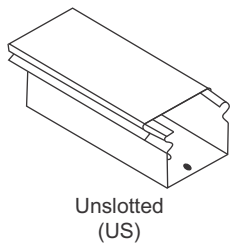



Covers for FRLS Cable Ducts

	Description	Cat. No.	M.R.P. (₹) Per Unit
	Cover for 15 mm A type	CCA15SG	25
	Cover for 25 mm A type	CCA25SG	39
	Cover for 30 mm A type	CCA30SG	48
	Cover for 45 mm A type	CCA45SG	75
	Cover for 60 mm A type	CCA60SG	91
	Cover for 75 mm A type	CCA75SG	114
	Cover for 80 mm A type	CCA80SG	136
	Cover for 100 mm A type	CCA100SG	166
	Cover for 25 mm B type	CCB25SG	39
	Cover for 30 mm B type	CCB30SG	48
	Cover for 40 mm B type	CCB40SG	61
	Cover for 45 mm B type	CCB45SG	75
	Cover for 50 mm B type	CCB50SG	91
	Cover for 60 mm B type	CCB60SG	91
	Cover for 72 mm B type	CCB72SG	114
	Cover for 75 mm B type	CCB75SG	114
	Cover for 80 mm B type	CCB80SG	136
	Cover for 100 mm B type	CCB100SG	166
	Cover for 120 mm B type	CCB120SG	178
	Cover for 150 mm B type	CCB150SG	208

Relays (8536)

M SERIES - MSP (Equivalent to MY)

MSP	Cat No.	Coil Volts	Min Pack	M.R.P. (₹) Per Unit
 <p>Type MSP (DC/AC) with LED indication - 5 Amps Resistive For 2 Pole / 3 Pole / 4 Pole</p>	MSP 2P 12	12V DC	20	182
	MSP 2P 24	24V DC	20	182
	MSP 2P 48	48V DC	20	205
	MSP 2P 110	110V DC	20	193
	MSP 2P 12A	12V AC	20	202
	MSP 2P 24A	24V AC	20	201
	MSP 2P 110A	110V AC	20	223
	MSP 2P 240A	240V AC	20	211
	MSP 3P 12	12V DC	20	190
	MSP 3P 24	24V DC	20	190
	MSP 3P 110	110V DC	20	204
	MSP 3P 24A	24V AC	20	231
	MSP 3P 110A	110V AC	20	240
	MSP 3P 240A	240V AC	20	250
	MSP 4P 12	12V DC	20	192
	MSP 4P 24	24V DC	20	193
	MSP 4P 48	48V DC	20	210
	MSP 4P 110	110V DC	20	210
	MSP 4P 12A	12V AC	20	244
	MSP 4P 24A	24V AC	20	223
MSP 4P 110A	110V AC	20	239	
MSP 4P 240A	240V AC	20	244	

MSP - Test Button	Cat No.	Coil Volts	Min Pack	M.R.P. (₹) Per Unit
 <p>2 Pole - 12 Amps 4 Pole - 7 Amps @ 277 V AC / 30 V DC with Flag & LED-UL Marked</p>	MSP2P012D12TNE	12V DC	20	216
	MSP2P024D12TNE	24V DC	20	216
	MSP2P110D12TNE	110V DC	20	227
	MSP2P012A12TNE	12V AC	20	236
	MSP2P024A12TNE	24V AC	20	235
	MSP2P110A12TNE	110V AC	20	257
	MSP2P240A12TNE	240V AC	20	245
	MSP4P012D07TNE	12V DC	20	247
	MSP4P024D07TNE	24V DC	20	248
	MSP4P110D07TNE	110V DC	20	265
	MSP4P012A07TNE	12V AC	20	299
	MSP4P024A07TNE	24V AC	20	278
	MSP4P110A07TNE	110V AC	20	294
	MSP4P240A07TNE	240V AC	20	299

Relays (8536)

M SERIES - MKG



MKG (DC/AC) with LED indication - 5 Amps Resistive at 24VDC/240 VAC Plug in Enclosed Version

MKG	Cat No.	Coil Volts	Min Pack	M.R.P. (₹) Per Unit
	MKG 2P 06	6V DC	10	246
	MKG 2P 12	12V DC	10	218
	MKG 2P 18	18V DC	10	260
	MKG 2P 24	24V DC	10	221
	MKG 2P 30	30V DC	10	293
	MKG 2P 48	48V DC	10	237
	MKG 2P 110	110V DC	10	264
	MKG 2P 220	220V DC	10	297
	MKG 3P 12	12V DC	10	276
	MKG 3P 18	18V DC	10	278
	MKG 3P 24	24V DC	10	278
	MKG 3P 30	30V DC	10	342
	MKG 3P 48	48V DC	10	331
	MKG 3P 110	110V DC	10	320
	MKG 3P 220	220V DC	10	431
	MKG 2P 06A	06V AC	10	242
	MKG 2P 12A	12V AC	10	226
	MKG 2P 24A	24V AC	10	219
	MKG 2P 110A	110V AC	10	221
	MKG 2P 240A	240V AC	10	283
	MKG 3P 12A	12V AC	10	270
	MKG 3P 24A	24V AC	10	264
	MKG 3P 110A	110V AC	10	269
	MKG 3P 240A	240V AC	10	327

M SERIES - MKP



Type MKP (DC/AC) with LED indication - 10 Amps Resistive at 24V DC/240V AC Plug in enclosed Version

MKP	Cat No.	Coil Volts	Min Pack	M.R.P. (₹) Per Unit
	MKP 2P 06	06V DC	10	251
	MKP 2P 12	12V DC	10	247
	MKP 2P 24	24V DC	10	248
	MKP 2P 48	48V DC	10	275
	MKP 2P 110	110V DC	10	276
	MKP 2P 220	220V DC	10	368
	MKP 3P 12	12V DC	10	306
	MKP 3P 24	24V DC	10	306
	MKP 3P 48	48V DC	10	341
	MKP 3P 110	110V DC	10	358
	MKP 3P 220	220V DC	10	488
	MKP 2P 06A	06V AC	10	268
	MKP 2P 12A	12V AC	10	262
	MKP 2P 24A	24V AC	10	262
	MKP 2P 110A	110V AC	10	270
	MKP 2P 240A	240V AC	10	352
	MKP 3P 12A	12V AC	10	345
	MKP 3P 24A	24V AC	10	345
	MKP 3P 110A	110V AC	10	339
	MKP 3P 240A	240V AC	10	389

Sockets for MK / MSP Series (8538)



SOCKETS	Cat No.	Coil Volts	Min. Pack	M.R.P. (₹) Per Unit
	MK 08C	8 Pin for 2 C/O & Closed Terminals for "MKG/MKP" Relays	20	60
	MK 11C	11 Pin for 3 C/O & Closed Terminals for "MKG/MKP" Relays	20	86
	MSP 08C	Closed Terminals Socket for MSP - 2 Pole	20	90
	MSP 14C	Closed Terminals Socket for MSP - 4 Pole	20	118
	MSP 14P	PCP Socket for MSP - 4 Pole	50	44

M SERIES - MIC

MIC	Cat No.	Coil Volts	Min Pack	M.R.P. (₹) Per Unit
 <p>MIC (DC/AC) - 12 Amps Resistive at 24V DC/240V AC enclosed solder / PCB Version</p>	MIC 2P 12	12V DC	20	200
	MIC 2P 24	24V DC	20	206
	MIC 3P 12	12V DC	20	231
	MIC 3P 24	24V DC	20	237

PCB Series - PCB

	Cat No.	Coil Volts	Min. Pack	M.R.P. (₹) Per Unit
 <p>TYPE PCB (5 AMPS) Enclosed version for PCB</p>	PCB 2P 12	12V DC	10	200
	PCB 2P 24	24V DC	10	208
	PCB 2P 240A	240V AC	10	392
	PCB 3P 12	12V DC	10	281
	PCB 3P 24	24V DC	10	289
	PCB 3P 240A	240V AC	10	437

M SERIES - MSC

MSC	Cat No.	Coil Volts	Min Pack	M.R.P. (₹) Per Unit
 <p>MSC (DC/AC) - 5 Amps Resistive at 24VDC/240 VAC Enclosed Solder Version</p>	MSC 1P 12	12V DC	10	124
	MSC 1P 18	18V DC	10	134
	MSC 1P 24	24V DC	10	128
	MSC 2P 06	06V DC	10	189
	MSC 2P 12	12V DC	10	176
	MSC 2P 18	18V DC	10	187
	MSC 2P 24	24V DC	10	182
	MSC 2P 48	48V DC	10	219
	MSC 3P 06	06V DC	10	247
	MSC 3P 12	12V DC	10	215
	MSC 3P 18	18V DC	10	224
	MSC 3P 24	24V DC	10	218
	MSC 3P 48	48V DC	10	296
	MSC 3P 110	110V DC	10	280
	MSC 2P 240A	240V AC	10	274
MSC 3P 240A	240V AC	10	302	

H SERIES - HSC

HSC	Cat No.	Coil Volts	Min Pack	M.R.P. (₹) Per Unit
 <p>HSC (DC/AC) - 10 Amps Resistive at 24V DC/240V AC Enclosed Solder Version</p>	HSC 1P 12	12V DC	10	174
	HSC 1P 18	18V DC	10	197
	HSC 1P 24	24V DC	10	184
	HSC 2P 12	12V DC	10	239
	HSC 2P 18	18V DC	10	284
	HSC 2P 24	24V DC	10	249
	HSC 3P 12	12V DC	10	300
	HSC 3P 18	18V DC	10	269
	HSC 3P 24	24V DC	10	311
	HSC 2P 240A	240V AC	10	381
	HSC 3P 240A	240V AC	10	431

Relays

H SERIES - HSR

HSR	Cat No.	Coil Volts	Min Pack	M.R.P. (₹) Per Unit
 <p>HSR (DC/AC) - 16 Amps Resistive at 24V DC/240V AC Enclosed Solder Version</p>	HSR 1P 12	12V DC	10	186
	HSR 1P 18	18V DC	10	205
	HSR 1P 24	24V DC	10	208
	HSR 2P 12	12V DC	10	265
	HSR 2P 18	18V DC	10	296
	HSR 2P 24	24V DC	10	273
	HSR 3P 12	12V DC	10	342
	HSR 3P 18	18V DC	10	399
	HSR 3P 24	24V DC	10	365
	HSR 2P 240A	240V AC	10	475
	HSR 3P 240A	240V AC	10	506

PRS SERIES - Power Relays (solderable)

PRS	Cat No.	Coil Volts	Min Pack	M.R.P. (₹) Per Unit
 <p>PRS 40 (DC/AC) - 40 Amps Resistive at 24V DC/240V AC / Enclosed Solder version</p>	PRS 40 1P 24 MP	24V DC	4	280

PRC SERIES - Power Relays

PRC	Cat No.	Coil Volts	Min Pack	M.R.P. (₹) Per Unit
 <p>PRC 30 (DC/AC) - 30 Amps Resistive at 24V DC/240V AC / Enclosed</p>	PRC 30 1P 12	12V DC	4	301
	PRC 30 1P 24	24V DC	4	305
	PRC 30 1P 12NO	12V DC	4	263
	PRC 30 2P 12	12V DC	4	407
	PRC 30 2P 24	24V DC	4	411
	PRC 30 2P 12NO	12V DC	4	373
	PRC 30 3P 12	12V DC	4	540
	PRC 30 3P 24	24V DC	4	543
	PRC 30 3P 12NO	12V DC	4	517
	PRC 30 3P 24 NO	24V DC	4	520
	PRC 30 1P 240A	240V AC	4	330
	PRC 30 2P 240A	240V AC	4	437
	PRC 30 3P 240A	240V AC	4	558

 <p>PRC 40 (DC/AC) - 40 Amps Resistive at 24V DC/240V AC / Enclosed</p>	PRC 40 1P 12	12V DC	4	329
	PRC 40 1P 24	24V DC	4	337
	PRC 40 1P 24A	24V AC	4	397
	PRC 40 1P 240A	240V AC	4	360

 <p>PRC 60 (DC/AC) - 60 Amps Resistive at 24V DC/240V AC / Enclosed</p> <p>PRC 80 (DC/AC)-80 Amps Resistive at 24V DC/240V AC / Enclosed</p> <p>PRC 100 (DC/AC) - 100 Amps Resistive at 24V DC/240V AC / Enclosed</p>	PRC 60 1P 12	12V DC	4	372
	PRC 60 1P 24	24V DC	4	382
	PRC 60 1P 240A	240V AC	4	455
	PRC 80 1P 12	12V DC	3	478
	PRC 80 1P 24	24V DC	3	491
	PRC 80 1P 240A	240V AC	3	643
	PRC 100 1P 12	12V DC	3	688
	PRC 100 1P 24	24V DC	3	717
	PRC 100 1P 240A	240V AC	3	738

Relay Modules (8536)

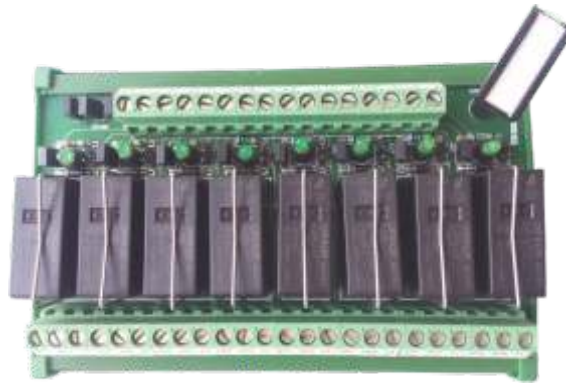

1 C/O RELAY MODULE

	Description	Modules	Cat No.	MRP (₹) Per Unit
	1 CO, 24VDC with OMRON Relay	2	RMS021P24	394
	1 CO, 24VDC with OMRON Relay	4	RMS041P24	725
	1 CO, 24VDC with OMRON Relay	8	RMS081P24	1218

2 C/O RELAY MODULE

	Description	Modules	Cat No.	MRP (₹) Per Unit
	2 CO, 24VDC with OMRON Relay	2	RMS022P24	520
	2 CO, 24VDC with OMRON Relay	4	RMS042P24	908
	2 CO, 24VDC with OMRON Relay	8	RMS082P24	1748

1 C/O RELAY MODULE

	Description	Modules	Cat No.	MRP (₹) Per Unit
	1 CO, 230VAC with OMRON Relay	2	RMS021P230AC	798
	1 CO, 230VAC with OMRON Relay	4	RMS041P230AC	1544
	1 CO, 230VAC with OMRON Relay	8	RMS081P230AC	3014

2 C/O RELAY MODULE

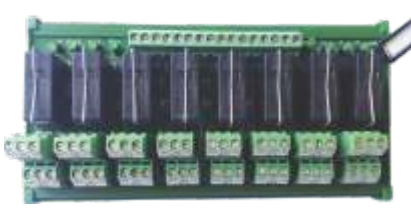
	Description	Modules	Cat No.	MRP (₹) Per Unit
	2 CO, 230VAC with OMRON Relay	2	RMS022P230AC	908
	2 CO, 230VAC with OMRON Relay	4	RMS042P230AC	1691
	2 CO, 230VAC with OMRON Relay	8	RMS082P230AC	3376

* Other Coil Voltages offered on request

PATENTED DESIGN



Single Phase - Automatic Changeover with Current Limiter

ACCL is used for efficient distribution of Single Phase generator power in Residential Apartments, commercial complex, townships etc without overloading the generator. The ACCL will switch the load to generator supply during mains failure. It also acts as a current limiter when load on generator exceeds the pre-set limit the ACCL goes into an Overload Trip cycle mode alerting users through LED indication / BEEP to reduce any excess load connected to the circuit.

RATING	DESCRIPTION	CODE	MRP (₹) Per Unit
0.5	ACCL with DG Trip at 0.5A / Mains 30A	RACCL005S	2500
1	ACCL with DG Trip at 1A / Mains 30A	RACCL010S	2500
1.5	ACCL with DG Trip at 1.5A / Mains 30A	RACCL015S	2500
2.5	ACCL with DG Trip at 2.5A / Mains 30A	RACCL025S	2500
3	ACCL with DG Trip at 3A / Mains 30A	RACCL030S	2500
4	ACCL with DG Trip at 4A / Mains 30A	RACCL040S	2500
5	ACCL with DG Trip at 5A / Mains 30A	RACCL050S	2500
6	ACCL with DG Trip at 6A / Mains 30A	RACCL060S	2500
8	ACCL with DG Trip at 8A / Mains 30A	RACCL080S	2500
9	ACCL with DG Trip at 9A / Mains 30A	RACCL090S	2500
10	ACCL with DG Trip at 10A / Mains 30A	RACCL100S	2500
15	ACCL with DG Trip at 15A / Mains 30A	RACCL150S	2500
20	ACCL with DG Trip at 20A / Mains 30A	RACCL200S	2500
25	ACCL with DG Trip at 25A / Mains 30A	RACCL250S	2500
30	ACCL with DG Trip at 30A / Mains 30A	RACCL300S	2600



Three Phase - Automatic Changeover with Current Limiter

ACCL is used for efficient distribution of Three Phase generator power in Residential Apartments , commercial complex , townships etc without overloading the generator. The ACCL will switch the load to generator supply during mains failure. It also acts as a current limiter when load on generator exceeds the pre-set limit the ACCL goes into an Overload Trip cycle mode alerting users through LED indication / Beep to reduce any excess load connected to the circuit.

Salzer is the pioneer in India to develop an ACCL's with a Heavy duty contactor design having Electrical / Mechanical interlock feature. With S-Mode (Wherein if any one phase fails the ACCL will disconnect from Mains supply and changeover to Generator supply) & T-Mode (Wherein if all three phase or R phase fails the ACCL will disconnect from Mains supply and changeover to Generator supply)

TPN - SPN				
RATING*	DESCRIPTION	CODE	MRP (₹) Per Unit	
6	TPN - SPN ACCL (DG Trip 6A / Mains 40A)	RACCLTS4006	13000	
10	TPN - SPN ACCL (DG Trip 10A / Mains 40A)	RACCLTS4010	13000	
15	TPN - SPN ACCL (DG Trip 15A / Mains 40A)	RACCLTS4015	13000	
20	TPN - SPN ACCL (DG Trip 20A / Mains 40A)	RACCLTS4020	13000	
25	TPN - SPN ACCL (DG Trip 25A / Mains 40A)	RACCLTS4025	13000	
30	TPN - SPN ACCL (DG Trip 30A / Mains 40A)	RACCLTS4030	13000	
40	TPN - SPN ACCL (DG Trip 40A / Mains 40A)	RACCLTS4040	13000	
63	TPN - SPN ACCL (DG Trip 63A / Mains 63A)	RACCLTS6363	23750	

TPN - TPN				
RATING*	DESCRIPTION	CODE	MRP (₹) Per Unit	
6	TPN - TPN ACCL (DG Trip 6A / Mains 40A)	RACCLTT4006	13800	
10	TPN - TPN ACCL (DG Trip 10A / Mains 40A)	RACCLTT4010	13800	
15	TPN - TPN ACCL (DG Trip 15A / Mains 40A)	RACCLTT4015	13800	
20	TPN - TPN ACCL (DG Trip 20A / Mains 40A)	RACCLTT4020	13800	
25	TPN - TPN ACCL (DG Trip 25A / Mains 40A)	RACCLTT4025	13800	
30	TPN - TPN ACCL (DG Trip 30A / Mains 40A)	RACCLTT4030	13800	
40	TPN - TPN ACCL (DG Trip 40A / Mains 40A)	RACCLTT4040	13800	
63	TPN - TPN ACCL (DG Trip 63A / Mains 63A)	RACCLTT6363	24500	

* MRP for 63/6 to 63/63 remains same for both TPN/TPN & SPN/SPN

Prices given here for **Grey Color**, for other colors 10% extra will be charged
(Other Color possible are Red / Yellow / Blue / Black / Green / White / Brown
with MOQ of 200 Nos per color)

Standard Feed through Screw Clamp Terminals



	Cat No.	Suitable for Wire Size (mm ²)	Std Pack Nos	M.R.P. (₹) Per Unit
	SCRW2.5U	2.5	100	9
	SCRW2.5UE	4	100	10
	SCRW4U	4	100	11
	SCRW6U	6	100	14
	SCRW10U	10	100	19
	SCRW16U	16	50	35
	SCRW25U	25	50	47
	SCRW35U	35	50	65
	SCRW50U	50	20	192
	SCRW95U	95	10	278

Double Level Terminals



	Cat No.	Suitable for Wire Size (mm ²)	Std Pack Nos	M.R.P. (₹) Per Unit
	DBL4U	4	100	28
	DBLOFF4U	4	100	28
	DBL4U(I.S.)	4	100	32
	Accessories			
	EPDBL 4U	DBL4U / DBL4U(I.S.)	100	10
	SPDBL 4U - Spacer	DBL4U / DBL4U(I.S.)	100	10
	EPDBLOFF 4U	DBLOFF4U / 4UA - FRONT SIDE	100	14
	EPDBLOFF4UA	DBLOFF4U / 4UA - BACK SIDE	100	6

Triple Level Terminals



	Cat No.	Suitable for Wire Size (mm ²)	Std Pack Nos	M.R.P. (₹) Per Unit
	TL2.5U	2.5	100	62
	TL2.5UH	2.5	100	35
	Accessories			
	EPTL2.5U	TL2.5U/UL	100	15
	EPTL2.5UH	TL2.5UH	100	15

Multiple Connection Terminals



	Cat No.	Suitable for Wire Size (mm ²)	Std Pack Nos	M.R.P. (₹) Per Unit
	SCRW 4U 1-2	4	100	22
	SCRW 4U 2-2	4	100	31
	Accessories			
	EPSCRW4U 1-2	SCRW 4U 1-2	100	10
	EPSCRW4U 2-2	SCRW 4U 2-2	100	14

Micro Terminals



	Cat No.	Suitable for Wire Size (mm ²)	Std Pack Nos	M.R.P. (₹) Per Unit
	M4	4	100	9
	Accessories			
	EPM4	M4	100	6
	PPM4	M4	100	7

Terminal Connectors

Fuse & Disconnect Terminals

	Cat No.	Suitable for Wire Size (mm ²)	Std Pack Nos	M.R.P. (₹) Per Unit
	F4U	4	100	39
	F4U(L)	4	100	51
	F6U	6	50	62
	FDBL4U	4	50	81
	FDBL4UE	4	50	93
	Accessories			
	EPF4U	F4U/F4U(L) / DISCTL4U	100	8
	PPF4U	F4U/F4U(L) / DISCTL4U	100	11
	EPFDBL4U	FDBL4U/4UE	100	14

Disconnect & Test Terminals

	Cat No.	Suitable for Wire Size (mm ²)	Std Pack Nos	M.R.P. (₹) Per Unit
	KN4U	4	50	38
	DISCT6U	6	50	77
	DISCT6US	6	25	151
	Accessories			
	EPKN4U	KN4U	100	9
	EPDISCT6U	DISCT6U / US	100	13

Stud Disconnect & Test Terminals for Current Transformer

	Cat No.	Suitable for Wire Size (mm ²)	Std Pack Nos	M.R.P. (₹) Per Unit
	STUDDISCT6U	6	25	63
	STUDDISCT6US	6	25	143
	Accessories			
	EPSTUDDISCT6U	STUDDISCT6U / STUDDISCT6US	100	13

Spring Clamp Terminals

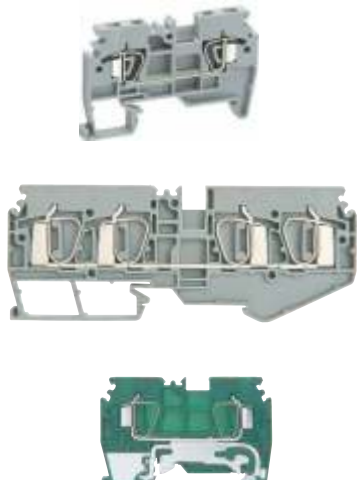
	Cat No.	Suitable for Wire Size (mm ²)	Std Pack Nos	M.R.P. (₹) Per Unit
	CAGE2.5	2.5	100	11
	CAGE4	4	450	16
	CAGE6	6	50	29
	CAGE2.5 1-2	2.5	100	18
	CAGE4 1-2	4	50	29
	CAGE6 1-2	6	50	55
	CAGE2.5 2-2	2.5	100	24
	CAGE4 2-2	4	50	36
	CAGE6 2-2	6	50	44
	CAGEP2.5	2.5	100	10
	CAGEP2.5 2-2	2.5	100	17
	CAGEG2.5	2.5	100	54
	CAGEG4	4	50	65
	CAGEG6	6	50	84

Stud Type Terminals

	Cat No.	Suitable for Wire Size (mm ²)	Std Pack Nos	M.R.P. (₹) Per Unit
	STUD B4	10	100	35
	STUD B5	16	100	38
	STUD N4	10	100	37
	STUD N5	16	100	42
	STUD B6	35	100	58
	STUD N6	35	100	57
	Accessories For Stud Type Terminals			
EPSTUD	STUD B4,B5., B6,N4,N5,N6		100	9
PPSTUD	STUD B4,B5., B6,N4,N5,N6		100	15

Grounding Terminals

	Cat No.	Suitable for Wire Size (mm ²)	Std Pack Nos	M.R.P. (₹) Per Unit
	G4	4	50	57
	GM4	4	100	36
	G6	6	50	69
	G10	10	20	77
	G16	16	50	98
	G35	35	20	195

Neutral / earth screw clamp busbar system

	Cat No.	Suitable for Wire Size (mm ²)	Std Pack Nos	M.R.P. (₹) Per Unit
	GN4	6	100	10
	GN16	16	50	13
	GN35	35	50	21
	NB10-3 (1 MTR)	COPPER BUS BAR (10x3)	5	515
	NB6-6 (1 MTR)	COPPER BUS BAR (6x6)	5	515
	NBS	NBS	50	11

Distribution Blocks

	Cat No.	Input (Sq.mm)	No. of Outputs	Std Pack Nos	M.R.P. (₹) Per Unit
	DISBL4/1	16	4	10	126
	DISBL4/2	16	8	10	152
	DISBL4/3	16	12	10	174
	DISBL4/4	16	16	10	228
	DISBL4/5	16	20	10	236
	DISBL4/2(1)	16	4	10	136
	DISBL4/3(1)	16	6	10	149
	DISBL4/4(1)	16	8	10	160
	DISBL4/5(1)	16	10	10	178
	DISBL4/6(1)	16	12	10	192
	DISBL4/10(1)	16	20	10	250
	DISBL4/11(1)	16	22	10	266
	DISBL6/2	25	8	10	162
	DISBL6/3	25	12	10	206
	DISBL6/4	25	16	10	220
	DISBL10/2	35	8	10	194
DISBL10/3	35	12	10	236	
DISBL10/4	35	16	10	280	

Terminal Connectors

Accessories - End Plates (8538)

	Cat No.	Suitable for Wire Size (mm ²)	Std Pack Nos	M.R.P. (₹) Per Unit
	EPSCRW2.5U/4U	SCRW2.5U/4U	100	6
	EPSCRW6U/10U	SCRW6U/10U	100	6
	EPSCRW25U	SCRW25U	100	8
	EPSCRW35U	SCRW35U	100	10
	EPCAGE2.5	CAGE2.5	100	7
	EPCAGE4	CAGE4	100	9
	EPCAGE6	CAGE6	100	13
	EPCAGE2.5 1-2	CAGE2.5 1-2	100	8
	EPCAGE4 1-2	CAGE4 1-2	100	10
	EPCAGE6 1-2	CAGE6 1-2	100	16
	EPCAGE2.5 2-2	CAGE2.5 2-2	100	10
	EPCAGE4 2-2	CAGE4 2-2	100	14
	EPCAGEP2.5	CAGEP2.5 (set of Left & Right)	100	9

Partition Plates

	Cat No.	Suitable for Wire Size (mm ²)	Std Pack Nos	M.R.P. (₹) Per Unit
	PPSCRW2.5U/4U	SCRW2.5U/4U	100	10
	PPSCRW6U/10U	SCRW6U/10U	100	13
	PPSCRW25U	SCRW25U	100	14
	PPSCRW35U	SCRW35U	100	16
	PPCAGE2.5	CAGE2.5	100	9
	PPCAGE4	CAGE4	100	11
	PPCAGE6	CAGE6	100	15
	PPCAGE2.5 1-2	CAGE2.5 1-2	100	11
	PPCAGE2.5 2-2	CAGE2.5 2-2	100	14
	PPCAGE4 1-2	CAGE4 1-2	100	14
	PPCAGE4 2-2	CAGE4 2-2	100	17
	PPCAGE6 1-2	CAGE6 1-2	100	17
	PPCAGE6 2-2	CAGE6 2-2	100	28

Separator Plate

	Cat No.	Suitable for Wire Size (mm ²)	Std Pack Nos	M.R.P. (₹) Per Unit
	SPSCRW2.5U/4U	SCRW2.5U/4U	100	5
	SPSCRW6U/10U	SCRW6U/10U	100	5
	SPSCRW16U	SCRW16U / SCRW16UCR	100	5
	SPDBL4U	DBL4U	100	5
	SPP4	P4	100	5

Group Marker Holders

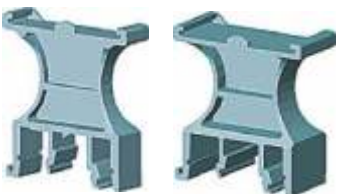
	Cat No.	Suitable for Wire Size (mm ²)	Std Pack Nos	M.R.P. (₹) Per Unit
	GRPM1	ES1N	100	8
	GRPM2	ES3N	100	8
	GRPM3	ES2N	100	8
	GRPM4	ES3N	100	8
	GRPM5	ES2N	100	8
	GRPM6	ALL MOUNTING RAILS	100	16
	GRPM7	ALL MOUNTING RAILS	100	21

Accessories

Marking Labels

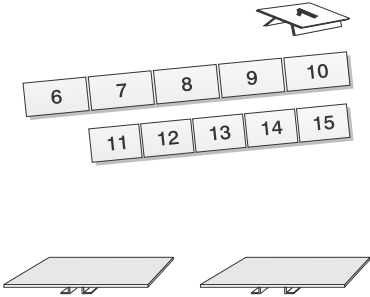

Cat No.	Suitable for Wire Size (mm ²)	Std Pack Nos	M.R.P. (₹) Per Unit
KM/2	DBL4U/4U(I.S) / P4 / F4U / FDBL4U / TL2.5U/UL/UH/UHL / M4/4S/4SU / DISCTL4U/DBLDISCTL4U/ GM4 / DBL4U(E) SERIES	100	1
KM/3	CAGEP2.5 2-2	100	1
KM/4	CAGEP2.5	100	1
KM/5	SCRW2.5U / GN4 / TH2.5U K/J/T / CAGE2.5/2.5 1-2/2-2	100	1
KM/6	SCRW4U/4U1-2/4U2-2 / DBL4U / DBLOFF4U/4UA / G4 / KN4U / GN16/35 / CAGE4/4 1-2/2-2 / DISBL4/1-5 / 4/2(1)-44(1)	100	1
KM/8	SCRW6U / F4U / DISBL6/2-4 / FDBL4U / 4U(E)/4ULR/4U(E)LR / DISCT6U/L6U / CAGE6/6 1-2	100	1
KM/10	SCRW10U / G10 / DISBL10/2-4	100	1
KM/12	SCRW16U/25U	100	1
KM/15	SCRW35U / G35	100	1
KM/50	SCRW50U	100	1
KM/95	SCRW95U	100	1
KM/G1,G2	ES1N OR M4/DBL4U/SCRW50U/95U	100	1

End Clamp / End Stopper



Cat No.	Suitable for Wire Size (mm ²)	Std Pack Nos	M.R.P. (₹) Per Unit
ES1S	DIN 35 RAIL	100	10
ES2S	DIN 35-15 RAIL	100	10
ES3S	DIN 32 RAIL	100	7
ES1N	DIN 15 RAIL	100	7
ES2N	DIN 35 / DIN 35-15 / DIN 32 RAIL	100	11
ES3N	DIN 35 RAIL / DIN 35-15 RAIL	100	9
MTGBKT18	STEEL	100	17
SPACER8			7
MTGBASE18	DIN 35/35-15	100	15

Din Rails / Channels



Cat No.	Std Pack Nos	M.R.P. (₹) Per Unit
DIN15/5.5MM - 1M (suitable for M4 Terminal)	100	71
DIN35/7.5MM - 1M (suitable for All Terminals)	50	95
DIN35/7.5MM - 1M - S (suitable for All Terminals)	50	100
DIN35/15MM - 1M (suitable for All Terminals)	50	152
DIN35/15MM - 1M - S (suitable for All Terminals)	50	168

Note: For Shorting links and other accessories please contact Factory

Limit & Foot Switches (8536)



SL201

SL202



SL203

SL200 Series

Cat No.	Description	Contact Details		MRP (₹) Per Unit
		Actuator	Action	
SL 201	Ball Actuator	Snap Action	1NO+1NC	676
SL 202	Roller Actuator	Snap Action	1NO+1NC	761
SL 203	Roller Lever Actuator	Snap Action	1NO+1NC	761
SL 207/1	Angular Roller Lever Actuator RS	Snap Action	1NO+1NC	761

Note: SL 207/1 - Angular Roller Lever Actuator Right Side



SL600/600P/600N



SL603



SL609

SL 600Series

Cat No.	Description	Contact Details		MRP (₹) Per Unit
		Actuator	Action	
SL 600	Only Push Rod Operated without Housing (without protection cover)	Snap Action	1NO+1NC	224
SL 600 P	Only Push Rod Operated without Housing (with protection cover)	Snap Action	1NO+1NC	297
SL 600 N	Only Push Rod Operated Without Housing	Normal Action	1NO+1NC	186
SL 600 NP	Only Push Rod Operated Without Housing (with protection cover)	Normal Action	1NO+1NC	217
SL 603	Aluminum Housing with Normal Roller Lever Actuator with IP65	Snap Action	1NO+1NC	635
SL 609	Aluminum Housing with Short Lever Roller Actuator with IP43	Snap Action	1NO+1NC	604

Note: SL600P - with protective Cover, SL600N-Normal Action, SL600 NP-Normal Action with protective cover



SL702

SL705



SL709

SL 700 Series

Cat No.	Description	Contact Details		MRP (₹) Per Unit
		Actuator	Action	
SL 702	Top Push Roller Spring Return	Snap Action	1NO+1NC	1193
SL 705	38mm Long, Rotating Roller Lever Spring Return	Snap Action	1NO+1NC	1193
SL 706-1	Nylon Catwhisker Spring Return	Snap Action	1NO+1NC	1126
SL 708	76mm long Rotating Roller Lever Spring Return	Snap Action	1NO+1NC	1238
SL 709	Rotating Adjustable Roller Lever (32mm-82.5mm) Spring Return	Snap Action	1NO+1NC	1227



SL1500-1A



SL1503-1AR

SL 1500 Series

Cat No.	Description	Contact Details		MRP (₹) Per Unit
SL1500-1A	Only Contact Block Without Operator	Snap Action	1NO+1NC	446
SL1502-2AH	Top Push Roller Operator Horizontal IP 65 from the Top	Snap Action	2NO+2NC	749
SL1503-1AR	Roller Lever Operator Right Hand Mounting	Snap Action	1NO+1NC	581
SL1503-2AR		Snap Action	2NO+2NC	749

Note: 1A - 1NO+1NC : 2AH - 2NO+2NC Horizontal operations
 1AR - 1NO+1NC, Right Hand Mounting
 2AR - 2NO+2NC, Right Hand Mounting



SFFS 1

SFFS

Cat No.	Description	Contact Details		MRP (₹) Per Unit
SFFS1	Compact Foot Switch	Snap Action	1NO+1NC	1537



SFFS 2/H1G



SFFS 2/H1S

SFFS2H

Cat No.	Description	Contact Details		MRP (₹) Per Unit
SFFS2H1G	Heavy Duty Switch with Guard	Snap Action	1NO+1NC	2954
SFFS2H11G	Heavy Duty Switch with Guard 2 Elements	Snap Action	1NO+1NC	3236
SFFS2H1S	Heavy Duty Switch with Shielded	Snap Action	1NO+1NC	3938



SFFS 3



SFFS 4

SFFS3 & 4

Cat No.	Description	Contact Details		MRP (₹) Per Unit
SFFS3	Domestic Switches	Snap Action	1NO+1NC	788

Plug & Socket (8536)

	Protection Type	Rating AMP	No of Poles	230V 50 & 60 Hz	400V 50 & 60 Hz	MRP (₹) Per Unit	
				Part Number	Part Number		
	Connectors	IP 44	16	2+E	IP01634-510	547	
		IP 44	16	3+E		IP01644-514	637
		IP 44	16	3+N+E		IP01654-5	644
		IP 44	32	2+E	IP03234-522		784
		IP 44	32	3+E		IP03244-526	917
		IP 44	32	3+N+E		IP03254-6	980
		IP 44	63	2+E	IP06334-1237		3713
		IP 44	63	3+E		IP06344-1241	3976
		IP 44	63	3+N+E		IP06354-1245	4200
	Plugs	IP 44	16	2+E	IP01634-248	379	
		IP 44	16	3+E		IP01644-252	491
		IP 44	16	3+N+E		IP01654-3	504
		IP 44	32	2+E	IP03234-260		605
		IP 44	32	3+E		IP03244-264	704
		IP 44	32	3+N+E		IP03254-4	788
		IP 44	63	2+E	IP06334-1227		2560
		IP 44	63	3+E		IP06344-1231	3360
		IP 44	63	3+N+E		IP06354-1235	3556
	Panel mounted socket, straight	IP 44	16	2+E	IP01634-1366	463	
		IP 44	16	3+E		IP01644-1390	672
		IP 44	16	3+N+E		IP01654-1385	678
		IP 44	32	2+E	IP03234-1395		743
		IP 44	32	3+E		IP03244-1399	857
		IP 44	32	3+N+E		IP03254-3451	894
		IP 44	63	2+E	IP06334-1261		2742
		IP 44	63	3+E		IP06344-1248	3052
		IP 44	63	3+N+E		IP06344-1252	3528
	Panel mounted socket, angled	IP 44	16	2+E	IP01634-1463	463	
		IP 44	16	3+E		IP01644-1467	672
		IP 44	16	3+N+E		IP01654-1473	678
		IP 44	32	2+E	IP03234-1492		743
		IP 44	32	3+E		IP03244-1496	857
		IP 44	32	3+N+E		IP03254-1500	894
		IP 44	63	2+E	IP06334-1147		2742
		IP 44	63	3+E		IP06344-1151	3052
		IP 44	63	3+N+E		IP06354-1155	3528
	Wall mounted socket	IP 44	16	2+E	IP01634-101	902	
		IP 44	16	3+E		IP01644-105	1115
		IP 44	16	3+N+E		IP01654-111	1215
		IP 44	32	2+E	IP03234-1421		1568
		IP 44	32	3+E		IP03244-1425	1698
		IP 44	32	3+N+E		IP03254-1557	1857
		IP 44	63	2+E	IP06334-1137		3657
		IP 44	63	3+E		IP06344-1141	3971
		IP 44	63	3+N+E		IP06354-1145	4445

	Protection Type	Rating AMP	No of Poles	230V 50 & 60 Hz	400V 50 & 60 Hz	MRP (₹) Per Unit
				Part Number	Part Number	

	Panel mounted inlets	IP 44	16	2+E	IP01634-812		527
		IP 44	16	3+E		IP01644-813	603
		IP 44	16	3+N+E		IP01654-815	672
		IP 44	32	2+E	IP03234-817		751
		IP 44	32	3+E		IP03244-819	852
		IP 44	32	3+N+E		IP03254-821	986
		IP 44	63	2+E	IP06334-1981		2537
		IP 44	63	3+E		IP06344-1982	2980
IP 44	63	3+N+E		IP06354-1688	3422		

	Wall mounted inlets	IP 44	16	2+E	IP01634-332		1003
		IP 44	16	3+E		IP01644-336	1238
		IP 44	16	3+N+E		IP01654-342	1395
		IP 44	32	2+E	IP03234-344		1745
		IP 44	32	3+E		IP03244-348	1891
		IP 44	32	3+N+E		IP03254-354	2061
		IP 44	63	2+E	IP06334-606		4064
		IP 44	63	3+E		IP06344-3607	4411
IP 44	63	3+N+E		IP06354-3608	4940		

	Wall mounted socket, Switched with interlock	IP 44	16	2+E	IP01634-7002		5040
		IP 44	16	3+E		IP01644-5100	6720
		IP 44	16	3+N+E		IP01654-5103	7840
		IP 44	32	2+E	IP03234-5696		8120
		IP 44	32	3+E		IP03244-5105	8400
		IP 44	32	3+N+E		IP03254-5108	9240
		IP 44	63	2+E	IP06334-6571		12615
		IP 44	63	3+E		IP06344-5956	13085
IP 44	63	3+N+E		IP06354-5959	16800		

	Wall mounted socket, Switched with interlock	IP 44	16	2+E	IP01634-7274		4234
		IP 44	16	3+E		IP01644-7275	4480
		IP 44	16	3+N+E		IP01654-7276	5320

Plug & Socket (8536)

	Protection Type	Rating AMP	No of Poles	230V 50 & 60 Hz	400V 50 & 60 Hz	MRP (₹) Per Unit	
				Part Number	Part Number		
	Connectors	IP 67	16	2+E	IP01636-540	1232	
		IP 67	16	3+E		IP01646-544	1443
		IP 67	16	3+N+E		IP01656-550	1443
		IP 67	32	2+E	IP03236-552		1680
		IP 67	32	3+E		IP03246-556	1779
		IP 67	32	3+N+E		IP03256-562	1779
		IP 67	63	2+E	IP06336-1574		4032
		IP 67	63	3+E		IP06346-1117	4366
		IP 67	63	3+N+E		IP06356-1121	4844
		IP 67	125	2+E	IP12536-3390		11200
		IP 67	125	3+E		IP12546-1450	11480
		IP 67	125	3+N+E		IP12556-1454	12600
	Plugs	IP 67	16	2+E	IP01636-278	476	
		IP 67	16	3+E		IP01646-282	1120
		IP 67	16	3+N+E		IP01656-288	1148
		IP 67	32	2+E	IP03236-290		1344
		IP 67	32	3+E		IP03246-294	1400
		IP 67	32	3+N+E		IP03256-300	1400
		IP 67	63	2+E	IP06336-1571		3543
		IP 67	63	3+E		IP06346-1110	3988
		IP 67	63	3+N+E		IP06356-1114	4200
		IP 67	125	2+E	IP12536-3400		8400
		IP 67	125	3+E		IP12546-1443	10920
		IP 67	125	3+N+E		IP12556-1447	11200
	Panel mounted socket, straight	IP 67	16	2+E	IP01636-218	980	
		IP 67	16	3+E		IP01646-222	1064
		IP 67	16	3+N+E		IP01656-228	1120
		IP 67	32	2+E	IP03236-230		1232
		IP 67	32	3+E		IP03246-234	1372
		IP 67	32	3+N+E		IP03256-240	1372
		IP 67	63	2+E	IP06336-1264		3360
		IP 67	63	3+E		IP06346-1124	3887
		IP 67	63	3+N+E		IP06356-1128	3920
		IP 67	125	2+E	IP12536-3380		8400
		IP 67	125	3+E		IP12546-1457	12320
		IP 67	125	3+N+E		IP12556-1461	12600
	Panel mounted socket, angled	IP 67	16	2+E	IP01636-1475	980	
		IP 67	16	3+E		IP06356-1479	1064
		IP 67	16	3+N+E		IP01656-1485	1120
		IP 67	32	2+E	IP03236-1502		1232
		IP 67	32	3+E		IP03246-1506	1372
		IP 67	32	3+N+E		IP03256-1551	1372
		IP 67	63	2+E	IP06336-2180		3360
		IP 67	63	3+E		IP06346-205	3887
		IP 67	63	3+N+E		IP06356-209	3920
		IP 67	125	2+E	IP12536-3575		8400
		IP 67	125	3+E		IP12546-212	12320
		IP 67	125	3+N+E		IP12556-216	12600

	Protection Type	Rating AMP	No of Poles	230V 50 & 60 Hz	400V 50 & 60 Hz	MRP (₹) Per Unit
				Part Number	Part Number	
	Wall mounted socket	IP 67	16	2+E	IP01636-1192	1387
	IP 67	16	3+E		IP01646-1196	1596
	IP 67	16	3+N+E		IP01656-1200	1624
	IP 67	32	2+E	IP03236-1202		1792
	IP 67	32	3+E		IP03246-1206	1960
	IP 67	32	3+N+E		IP03256-1210	1960
	IP 67	63	2+E	IP06336-128		4002
	IP 67	63	3+E		IP06346-132	4312
	IP 67	63	3+N+E		IP06356-136	5029
	IP 67	125	2+E	IP12536-1381		11060
	IP 67	125	3+E		IP12546-139	12320
	IP 67	125	3+N+E		IP12556-143	13720
	Panel mounted inlets	IP 67	16	2+E	IP01636-826	672
	IP 67	16	3+E		IP01646-827	771
	IP 67	16	3+N+E		IP01656-829	858
	IP 67	32	2+E	IP03236-831		980
	IP 67	32	3+E		IP03246-832	1092
	IP 67	32	3+N+E		IP03256-834	1260
	IP 67	63	2+E	IP06336-836		2787
	IP 67	63	3+E		IP06346-3656	3235
	IP 67	63	3+N+E		IP06356-3658	3683
	IP 67	125	2+E	IP12536-3665		6076
	IP 67	125	3+E		IP12546-3583	7252
	IP 67	125	3+N+E		IP12556-1983	8415
	Wall mounted inlets	IP 67	16	2+E	IP01636-1003	1372
	IP 67	16	3+E		IP01646-1004	1471
	IP 67	16	3+N+E		IP01656-1005	1680
	IP 67	32	2+E	IP03236-1006		1988
	IP 67	32	3+E		IP03246-1007	2128
	IP 67	32	3+N+E		IP03256-1008	2339
	IP 67	63	2+E	IP06336-1107		4452
	IP 67	63	3+E		IP06346-357	4803
	IP 67	63	3+N+E		IP06356-361	5600
	Wall mounted socket, Switched with interlock	IP 67	16	2+E	IP01636-7012	7280
	IP 67	16	3+E		IP01646-5600	7560
	IP 67	16	3+N+E		IP01656-5603	9520
	IP 67	32	2+E	IP03236-5793		9520
	IP 67	32	3+E		IP03246-5605	10360
	IP 67	32	3+N+E		IP03256-5608	12320
	IP 67	63	2+E	IP06336-5911		14000
	IP 67	63	3+E		IP06346-5110	16100
	IP 67	63	3+N+E		IP06356-5113	21000

Plug & Socket (8536)

	Protection Type	Rating AMP	No of Poles	230V 50 & 60 Hz	400V 50 & 60 Hz	MRP (₹) Per Unit
				Part Number	Part Number	
 <p>Wall mounted socket, Switched with interlock</p>	IP 67	16	2+E	IP01636-7278		6440
	IP 67	16	3+E		IP01646-7279	6720
	IP 67	16	3+N+E		IP01656-7280	8120
 <p>Schuko plug</p>	IP 54	16	2+E	IP01635-10838		336
 <p>Schuko connector</p>	IP 54	16	2+E	IP01635-10843		437
 <p>Schuko panel mounted socket</p>	IP 54	16	2+E	IP01635-11031		364

Other Products

Contactors & Overload Relays

Standard Contactors 9A to 105 Amps
Mini Contactor from 7A to 16 Amps & Control Relay 16 Amps. Bimetallic Over Load Relay from 0.28-112 Amps, with a wide range of Accessories



Motor Protection Circuit Breaker (MPCB)

In 32 & 63 Amps, Motor Disconnect function, Branch circuit protection, Motor control & Overload protection Relay range upto 63 Amps with UL listing



MCB'S & Distribution Boards

MCB's are offered in various current ratings from 0.5 to 63 Amps. Enclosures, Plug & Sockets, Single Phase DB, Three Phase DB, Vertical DB, Phase Selector DB, 7 & 8 Segment DB's etc.



Toroidal Transformers / Current Transformers

Single Phase 15VA - 30KVA & Three Phase 1KVA - 120KVA. CT's : Accuracy Class of 0.2 to 3 with burden of 5 to 30VA, Primary Current upto 4000A & Secondary of 5A / 1A



Toroidal Inductors & Chokes

Toroidal Choke : 40 KVA to 250 KVA, Upto 300 Amps
Power Chokes & Inductors:
Range : 0.1 to 100 mH, Upto 20 Amps



Transformers & Chokes / Inductors / Reactors

- Dry type Magnetics - VPI, AN - AF - Water Cooling etc.
- Transformers Range: 1KVA to 1MVA, 1Phase and 3Phase
- **Chokes / Inductors / Reactors Range:** 1KVAr to 1MVA 1Phase and 3 Phase



Sensors

Speed Sensors : Active/Passive Sensors with Speed range upto 30,000 rpm in Square/Sine wave output.
Position Sensors : Active/Passive Sensors with Rotation angle 0-90/0-180 & 0-360 with Analogue/Resistive output signal
Temperature Sensors : NTC/PTC types with Resistive output signal
Pressure Sensors : Absolute/Relative pressure from 0 to 1000 bar with Ratiometric Voltage/current output signal, with different ingress protection of IP65/IP67/IP69K



Wires & Cables

Range from 0.5 sq mm to 300 sq mm
Building Wires, Flexible Wires, Multi Core Cables, Flat Cables, HFFR, FRLS, ZHFR Wires, UL Rated Wires, Shielded & Braided Wires
Bunched Conductors, Tinned Copper wires & Customised cables.



Wire Harness / Power Cords

Wire Harness for: Industrial Applications, Consumer Electronics, Automobile Industries, Medical Electronics. UL Approved. Power Cords as per Indian, European & American Standards





Guarantee :

All prices are maximum retail price basis inclusive GST and any other Tax as applicable.

All the products listed in the price list carry a warranty, against manufacturing defects.

The warranty is however subject to provision of proper usage, effective maintenance, it does not cover faulty operation and willful or accidental damage.

The user needs to take adequate precautions to eliminate these conditions. The manufacturer shall not be liable for any consequential loss, injury or damages attributable to defect or failure of its products.

Product development is a continuous process and hence data / prices given are subject to change without notice. Disputes if any are subject to Coimbatore jurisdiction only.

Salzer Electronics Limited

Samichettipalayam, Jothipuram Post, Coimbatore 641047. INDIA

Tel : +91-422- 4233600 | Fax : +91-422-2692170 | e-mail : sales@salzergroup.com

www.salzergroup.com