

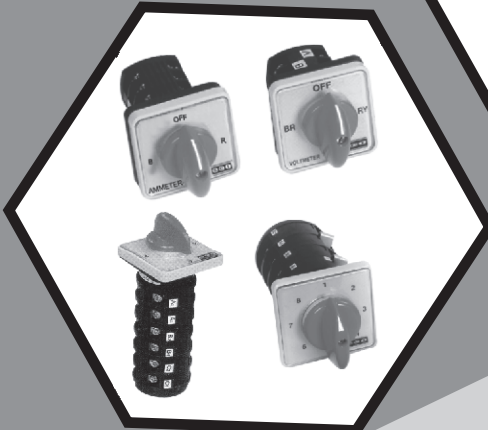

AN ISO 9001 : 2015 COMPANY

PRICE LIST

w.e.f. March 2021

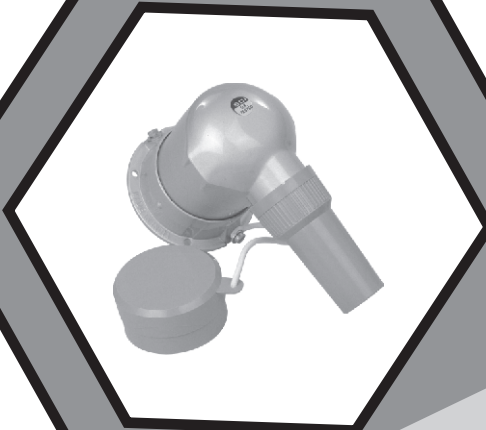
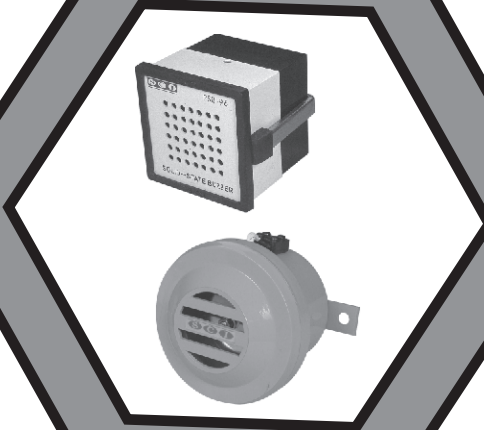
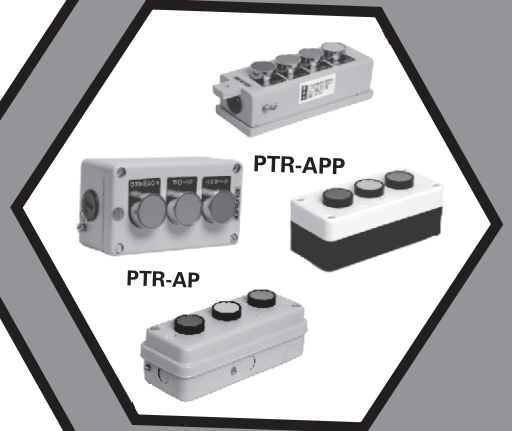
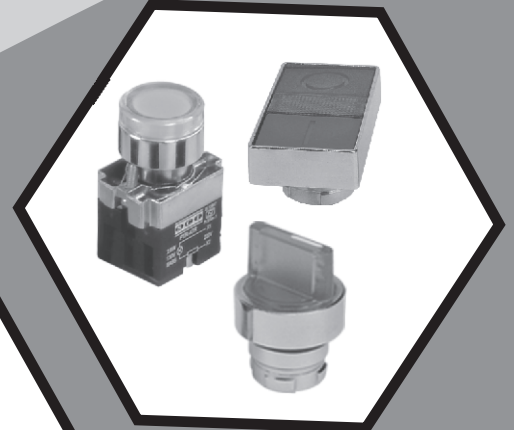

SWITCH CONTROL (INDIA)

L. V. SWITCH GEAR & CONTROL GEAR
Advancing Switch Control Integration

I N D E X

CONTENTS	PAGE
■ METAL CLAD PLUGS & SOCKETS	02
■ H.R.C. FUSE BASES OPEN TYPE	02
■ H.R.C. FUSE HOLDERS.....	02
■ 22.5 mm DIA PTR SERIES PUSH BUTTON & SELECTOR ACTUATORS.....	03
■ 22.5 mm DIA PTR SERIES CONTACT ELEMENTS	03
■ 22.5 mm DIA PTR SERIES LUMINOUS ACTUATORS	03
■ 22.5 mm DIA PTR SERIES PILOT LIGHTS (INCLUDING L.E.D. TYPE).....	04
■ 22.5 mm DIA PTR SERIES PUSH BUTTON STATIONS.....	04
■ 22.5 mm DIA PTR SERIES SPARES AND ACCESORIES.....	04
■ 22.5 mm PUSH BUTTON UNITS (PLASTIC BODY)	05
■ 22.5 mm PUSH BUTTON UNITS (SHEET METAL HOUSING)	05
■ SOLID STATE BUZZERS.....	05
■ FUSE LINK.....	05
■ CAM OPERATED ROTARY SWITCHES (6A)	06
■ AMMETER SELECTOR SWITCHES	07
■ VOLTMETER SELECTOR SWITCHES.....	07
■ CAM OPERATED ROTARY SWITCHES (10A, 16A, 25A, 32A, 40A, 63A)	08
■ CAM OPERATED ROTARY SWITCHES MOTOR DUTY APPLICATIONS	09
■ CAM OPERATED ROTARY SWITCHES FORWARD-OFF-REVERSE, PHASE CHANGEOVERS.....	09
■ CAM OPERATED ROTARY SWITCHES FOR CHANGEOVER & METAL BOX ENCLOSURES	10
■ SWITCHES WITH METAL BOX.....	10
■ SPRING RETURN SWITCHES	10
■ CAM OPERATED ROTARY SWITCH SPARES.....	11
■ TERMS AND CONDITIONS	11

w.e.f. March 2021

METAL CLAD PLUGS & SOCKETS (ALUMINIUM DIE CAST) TYPE-SC

DESCRIPTION	RATING AMPS.	CAT NO.	UNIT PRICE	STD. PACKING
PLUGS				
2 Pole + Earth, 250V	10 A	DP 10	114.00	20
2 Pole + Earth, 250V	20 A	DP20	120.00	20
3 Pole + Earth, 440V	20 A	TP20	166.00	20
3 Pole + Earth, 440V	30 A	TP30	331.00	12
SOCKETS				
2 Pole + Earth, 250V	10 A	DS 10	120.00	20
2 Pole + Earth, 250V	20 A	DS 20	136.00	20
3 Pole + Earth, 440V	20 A	TS 20	177.00	20
3 Pole + Earth, 440V	30 A	TS 30	354.00	12



Conduit Box For DS 10-Rs. 40.00, For DS 20-Rs. 44.00, For TS 20-Rs. 48.00, For TS 30-Rs. 54.00

PLUGS & SOCKETS IN SHEET STEEL ENCLOSURE (WITHOUT MCB)



DESCRIPTION	RATING AMPS.	CAT NO.	UNIT PRICE	STD. PACKING
2 Pole + Earth, 250V Plug & Socket In S.S. Enclosure	10A	DPSB10	612.00	01
2 Pole + Earth, 250V Plug & Socket In S.S. Enclosure	20A	DPSB20	695.00	01
3 Pole + Earth, 250V Plug & Socket In S.S. Enclosure	20A	TPSB 20	1047.00	01
3 Pole + Earth, 250V Plug & Socket In S.S. Enclosure	30A	TPSB 30	1449.00	01

HRC FUSE BASES TYPE FBO

DESCRIPTION	CAT NO.	UNIT PRICE	STD. PACKING
160 Amps In Bakelite Moulding With Cirdip Contact	FBO-160C	202.00	10
250 Amps In Bakelite Moulding With Cirdip Contact	FBO-250C	538.00	01
400 Amps In Bakelite Moulding With Cirdip Contact	FBO-400C	791.00	01
630 Amps In Bakelite Moulding With Cirdip Contact	FBO-630C	1109.00	01
160 Amps In DMC Moulding With Cirdip Contact	FBO-160CD	219.00	01
250 Amps In DMC Moulding With Cirdip Contact	FBO-250CD	582.00	01
400 Amps In DMC Moulding With Cirdip Contact	FBO-400CD	840.00	01
630 Amps In DMC Moulding With Cirdip Contact	FBO-630CD	1139.00	01
250 Amps In Sheet Metal Plate	FBO-250LT	751.00	01
400 / 630 Amps In Sheet Metal Plate	FBO-630LT	874.00	01

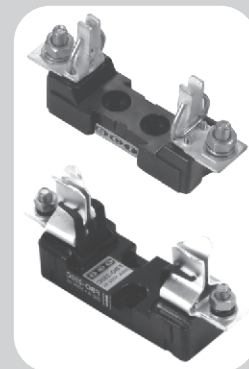

BAKELITE MOULDED FUSE HOLDERS TYPE SC



DESCRIPTION	CAT NO.	UNIT PRICE	STD. PACKING
20 Amps Front Connection	SC-20H	99.00	10
20 Amps Bus Bar Connection	SC-20B	127.00	10
20 Amps Back Connection	SC-20P	161.00	10
32 Amps Front Connection	SC-32H	177.00	10
32 Amps Bus Bar Connection	SC-32B	207.00	10
63 Amps Front Connection	SC-63H	250.00	10
63 Amps Bus Bar Connection	SC-63B	322.00	10
125 Amps Front Connection	SC-125H	621.00	10
125 Amps Bus Bar Connection	SC-125B	725.00	10

ACTUATORS WITH METALLIC FRONT RING AND BEZEL

**PTR SERIES-
CUTOUT DIA 22.5 mm**

DESCRIPTION	CAT NO.	UNIT PRICE	STD. PACKING
Flush Buttons -	PTR-AS	62.00	20
Flush Booted Button -	PTR-ADP	90.00	20
Projecting Button -	PTR-AU	76.00	10
Mushroom Button -	PTR-AM	90.00	10
Mushroom Stayput-Press To Lock And Turn To Release	PTR-AMS	117.00	10
Mushroom Jumbo Button Press To Lock Turn To Reset	PTR-AJB	140.00	05
Mushroom Jumbo Button Spring Return	PTR-AJBS	166.00	05
Selector Two Position Maintained	PTR-A22	147.00	10
Selector Two Position Spring Return	PTR-A22S	147.00	10
Selector Three Position Maintained	PTR-A33	147.00	10
Selector Three Position Spring Return	PTR-A33S	147.00	10
Key Selector Two Position Lockable In Both Position	PTR-A2K	230.00	10
Key Selector Three Position Lockable In Both Position	PTR-A3K	230.00	10
Emergency Stop Press To Lock And Key To Reset	PTR-APL	304.00	10
Twin-spring Return, G Knob Marked 'I' & R Knob Marked 'O'	PTR-ATB	129.00	20



CONTACT ELEMENT SUITABLE FOR ACTUATORS



DESCRIPTION	CAT NO.	UNIT PRICE	STD. PACKING
NO Contact For Rear Connection	PTR-A1	51.00	50
NC Contact For Rear Connection	PTR-A2	51.00	50

LUMINOUS ACTUATOR WITH METALLIC FRONT RING AND BEZEL



DESCRIPTION	CAT NO.	UNIT PRICE	STD. PACKING
Luminous Spring Return Actuator, With Poly Carbonate Lens, Bulb, Series Resistor For 220V, 110V, 48V, 24V	PTR-ATR	161.00	10
Luminous Spring Return Actuator, With Poly Carbonate Lens, Bulb, But Without Series Resistor For 220V, 110V, 48V, 24V	PTR-AT	156.00	10
Luminous Spring Return Actuator With Poly Carbonate Lens And Cluster L.E.D. For 220V, 110V, 48V, 24V AC or DC	PTR-ATLED	216.00	10
Twin Luminous Spring Return Green Knob Marked 'I' & Red Knob Marked 'O' With Amber Lamp, Series Resistor Suitable For 220V, 110V, 48V, 24V	PTR-ATBLR	216.00	08
Twin Luminous Spring Return Green Knob Marked 'I' & Red Knob Marked 'O' With Amber Lamp, But Without Series Resistor For 220V, 110V, 48V, 24V	PTR-ATBL	209.00	08
Twin Luminous Spring Return Green Knob Marked 'I' & Red Knob Marked 'O' With Poly Carbonate Lens & Cluster L.E.D For 220V, 110V, 48V, 24V AC or DC	PTR-ATBLED	278.00	08
Luminous Selector 2 Position With Poly Carbonate Knob, Bulb Series Resistor For 220V, 110V, 48V, 24V	PTR-A2PLSR	242.00	10
Luminous Selector 2 Position With Poly Carbonate Knob, Bulb But Without Series Resistor For 110V, 48V, 24V	PTR-A2PLSD	232.00	10
Luminous Selector 2 Position With Poly Carbonate Lens & Cluster L.E.D. For 220V, 110V, 48V, 24V AC or DC	PTR-A2PLLED	281.00	10
Luminous Selector 3 Position With Poly Carbonate Knob, Bulb Series Resistor For 220V, 110V, 48V, 24V	PTR-A3PLSR	242.00	10
Luminous Selector 3 Position With Poly Carbonate Knob, Bulb But Without Series Resistor For 220V, 110V, 48V, 24V	PTR-A3PLSD	232.00	10
Luminous Selector 3 Position With Poly Carbonate Lens & Cluster L.E.D. For 220V, 110V, 48V, 24V AC or DC	PTR-A3PLLED	281.00	10

PILOT LIGHT (INCLUDING L.E.D. TYPE)

w.e.f. March 2021



DESCRIPTION	CAT NO.	UNIT PRICE	STD. PACKING
Pilot Light With Poly Carbonate Lens, Lamp Holder, Bulb, Series Resistor Suitable For 220V, 110V, 48V, 24V	PTR-ALR	138.00	10
Pilot Lights With Poly Carbonate Lens With Cluster L.E.D For 220V, 110V, 48V, 24V	PTR-ALED	170.00	10
Pilot Lights In Barrel Type Poly Carbonate Lens With Surface Mounted L.E.D For 220V, 110V, 48V, 24V	PTR-AFLED	104.00	20

- For Blue/White Colour Add Rs. 50 Each In The Above Prices
- Colours Available are: Red, Amber, Yellow, Blue and White

PUSH BUTTON STATION

SURFACE MOUNTING ALUMINUM CASTING			PENDENT ALUMINIUM CASTING
DESCRIPTION	PTR-AP SERIES		PTR-APP SERIES
ONE WAY	PTR-API	437.00	508.00
	API + AMS	488.00	
TWO WAY	PTR-AP2	610.00	696.00
	AP2 + AMS	695.00	
THREE WAY	PTR-AP3	810.00	922.00
FOUR WAY	PTR-AP4	1035.00	1118.00
SIX WAY	PTR-AP6	1695.00	1834.00
EIGHT WAY	PTR-AP8	2122.00	2340.00
TEN WAY	PTR-AP10	2524.00	2634.00
TWELVE WAY	PTR-AP12	3018.00	3140.00
FOURTEEN WAY	PTR-AP14	3510.00	3657.00
EIGHTEEN WAY	PTR-AP18	4823.00	4968.00

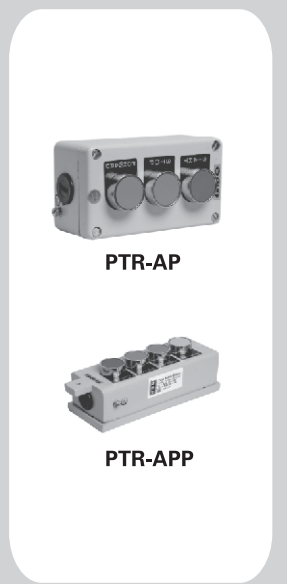

Standard packing is 01 for all, except PTR-AP1 which is 02

- For Push Button Station With Canopy, Add 10% Extra On The Above Prices.
- All Above Push Button Stations Have Flush Button With 1NO or 1NC Contact Element.
- Different Actuator/Contact Block Arrangement Can Be Quoted On Request

PTR SERIES SPARES AND ACCESORIES

DESCRIPTION	CAT NO.	UNIT PRICE	STD. PACKING
Legend Plates With Inscription On, Off, Start, Stop, Forward, Reverse, Test, Accept, Emergency, Reset & Blank	PTR-ASLP	12.00	100
Poly Carbonate Lens Without Lens Holder Suitable For Pilot Light	PTR-ASL	16.00	50
Lens Holder Assembly With Poly Carbonate Lens	PTR-ASLA	74.00	20
Lens Holder Assembly With Poly Carbonate Lens & Ring Suitable For Luminous Light	PTR-ASILA	78.00	20
Filament Bulb BA-9S 2.6 Watt In 130V, 110V, 48V, 24V	PTR-ASBL	41.00	100
Protective Rubber Boot	PTR-ASPB	32.00	20
Bulb Extractor (bulb Puller)	PTR-ASBE	32.00	10
Adopter For Fixing Dia 22.5 mm In Dia 30.5 mm Hole	PTR-ASAP	21.00	50
Blanking Plug For Dia 22.5 mm Hole	PTR-ASBP	25.00	50

w.e.f. March 2021

PUSH BUTTON UNITS (PLASTIC BODY) 1NO + 1NC (PANEL CUTOUT DIA 22.5 mm)

DESCRIPTION	CAT NO.	UNIT PRICE	STD. PACKING
Flush Knob 1 NO + 1NC	PTR-BTH	32.00	20

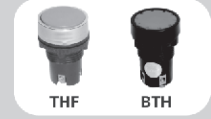

PUSH BUTTON UNITS (PLASTIC BODY) 1NO + 1NC (PANEL CUTOUT DIA 29.5 mm)

Flush Knob 1 NO + 1NC	PTR-AD	37.00	20
-----------------------	--------	-------	----

• Colours available are : Red, Green, Yellow, Black, White and Blue



PUSH BUTTON CONTROL UNITS (PLASTIC DUAL COLOUR) WITH 1NO + 1NC (DIA 22.5 mm)

DESCRIPTION	CAT NO.	UNIT PRICE	STD. PACKING
One Way with BTH (Dia 22.5 mm)	PTR-P1	120.00	2
Two Way with BTH (Dia 22.5 mm)	PTR-P2	166.00	1
Three Way with BTH (Dia 22.5 mm)	PTR-P3	228.00	1



Please contact to dealer for PTR-THF Push Button Control Units.

PUSH BUTTON CONTROL UNITS WITH 1NO + 1NC - POWER COATED SHEET METAL HOUSING

DESCRIPTION	CAT NO.	UNIT PRICE	STD. PACKING
One Way with BTH (Dia 22.5 mm)	PTR-AS1	147.00	2
Two Way with BTH (Dia 22.5 mm)	PTR-AS2	198.00	1
Three Way with BTH (Dia 22.5 mm)	PTR-AS3	265.00	1



Please contact to dealer for PTR-THF Push Button Control Units.

SOLID STATE BUZZERS TYPE - AB

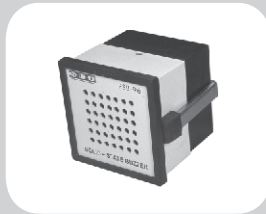

DESCRIPTION	CAT NO.	UNIT PRICE	STD. PACKING
Moulded Housing, Suitable For 230V, 110V, 48V, 24V AC (96 x 96)	PTR-ABA/ABD	903.00	01
Moulded Housing, Suitable For 230V, 110V, 48V, 24V AC (96 x 96) (MULTI TONE)	PTR-ABAM/ABDM	975.00	01
Moulded Housing, Suitable For 230V, 110V, 48V, 24V AC (72 x 72)	PTR-ABAS/ABDS	759.00	01
Moulded Housing, Suitable For 230V, 110V, 48V, 24V AC (72 x 72) (MULTI TONE)	PTR-ABAMS/ABDMS	902.00	01

INDUSTRIAL HOOTERS TYPE-AH

DESCRIPTION	CAT NO.	UNIT PRICE	STD. PACKING
Moulded Housing, Suitable For 230V, 110V, 48V, 24V AC	PTR-AHA	748.00	01
Moulded Housing, Suitable For 220V, 110V, 48V, 24V DC	PTR-AHD	886.00	01

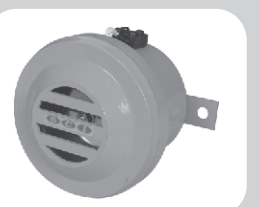

SCNS TYPE FUSE LINK WITH STAGGERED TAGS 415V AC

RATING AMPS.	CAT NO.	UNIT PRICE	STD. PACKING
2A	SC-NS2	37.00	20
To	To		
32A	SC-NS32		

TYPE T-660 AC OFFSET TAGS (2 HOLE FIXING-BOLTED)

RATING AMPS.	CAT NO.	UNIT PRICE	STD. PACKING
32A	SC-TIA32	74.00	10
63A	SC-TIS63	83.00	10
100A	SC-TCP100	191.00	10
125A	SC-TCP125	221.00	10

Fuse link conform to IS : 13703 IEC 269



CAM OPERATED ROTARY SWITCHES (SWITCHES - 6 AMPS. TYPE 'SC6')

SWITCHING	POLE	PROGRAMME	UNIT PRICE
ON - OFF (60°)	1	SI001	120.00
	2	SI002	145.00
	3	SI003	159.00
	4	SI004	190.00
TWO WAY NO OFF (90°)	1	SI037	145.00
	2	SI038	190.00
	3	SI039	228.00
	4	SI040	281.00
TWO WAY WITH OFF (60°)	1	SI025	145.00
	2	SI026	190.00
	3	SI027	224.00
	4	SI028	281.00
THREE WAY NO OFF (60°)	1	SI049	167.00
	2	SI069	228.00
	3	SI089	336.00
	4	SI120	405.00
THREE WAY WITH OFF (90°)	1	SI060	167.00
	2	SI080	229.00
	3	SI100	336.00
	4	SI131	405.00
FOUR WAY NO OFF (90°)	1	SI050	190.00
	2	SI070	285.00
	3	SI090	368.00
	4	SI121	481.00
FOUR WAY WITH OFF (60°)	1	SI061	202.00
	2	SI081	336.00
	3	SI101	449.00
	4	SI132	534.00
FIVE WAY NO OFF (60°)	1	SI051	228.00
	2	SI071	384.00
	3	SI091	513.00
FIVE WAY WITH OFF (60°)	1	SI062	228.00
	2	SI082	384.00
	3	SI102	513.00

SWITCHING	POLE	PROGRAMME	UNIT PRICE
SIX WAY NO OFF (60°)	1	SI052	228.00
	2	SI072	435.00
	3	SI092	569.00
SIX WAY WITH OFF (45°)	1	SI063	296.00
	2	SI083	513.00
	3	SI103	688.00
SEVEN WAY WITH OFF (45°)	1	SI064	301.00
	2	SI084	513.00
	3	SI104	658.00
SEVEN WAY WITH NO OFF (45°)	1	SI053	301.00
	2	SI073	513.00
	3	SI093	658.00
EIGHT WAY WITH NO OFF (45°)	1	SI054	301.00
	2	SI074	559.00
	3	SI094	748.00
EIGHT WAY WITH OFF (30°)	1	SI065	301.00
	2	SI085	559.00
NINE WAY WITH NO OFF (30°)	1	SI055	345.00
	2	SI075	573.00
NINE WAY WITH OFF (30°)	1	SI066	347.00
	2	SI086	612.00
TEN WAY WITH OFF (30°)	1	SI056	363.00
	2	SI076	633.00



CAM OPERATED ROTARY SWITCHES (SWITCHES- 6 AMPS. TYPE 'SC6')

SWITCHING	POLE	PROGRAMME	UNIT PRICE	SWITCHING	POLE	PROGRAMME	UNIT PRICE
TEN WAY WITH NO OFF (30°) 	1	SI067	573.00	ELEVEN WAY WITH OFF (30°) 	1	SI068	582.00
	2	SI087	679.00		2	SI088	736.00
ELEVEN WAY NO OFF (30°) 	1	SI057	573.00	TWELVE WAY NO OFF (30°) 	1	SI058	582.00
	2	SI077	718.00		2	SI078	780.00

AMMETER SELECTOR SWITCHES

SWITCHING	POLE	AMPS.	TYPE	PROGRAMME	DESCRIPTION	UNIT PRICE
	03	06	SC6	SI325	To Read Current To Be Used With Ct With Off	219.00
	03	10	SC10	SI325	--Do--	260.00
	03	10	SC10	SI710		840.00
	03	16	SC16	SI710	Direct Reading	890.00
	03	25	SC25	SI710	Ammeter Selector	955.00
	03	32	SC32	SI710	Switches Without Ct's	1035.00
	03	40	SC40	SI710		1501.00
	03	63	SC63	SI710		1656.00

VOLTMETER SELECTOR SWITCHES











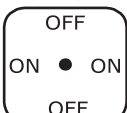

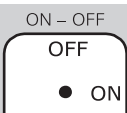



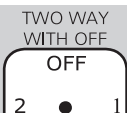

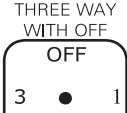
SWITCHING	POLE	AMPS.	TYPE	PROGRAMME	DESCRIPTION	UNIT PRICE
	03	06	SC6	SI312	Voltage Between Phase To Phase With Off	161.00
	03	10	SC10	SI312	--Do--	230.00
	03	06	SC6	SI313	Voltage Between Phase To Phase And Phase To Neutral With Off	301.00
	03	10	SC10	SI313	--Do--	477.00
	03	06	SC6	SI311	Voltage Between Phase To Neutral With Off	281.00
	03	10	SC10	SI314	Voltage Between Phase To Phase And Phase To Neutral Without Off	477.00

AMMETER VOLTMETER COMBINED SELECTOR SWITCHES

SWITCHING	POLE	AMPS.	TYPE	PROGRAMME	DESCRIPTION	UNIT PRICE
	03	10	SC10	SI370	Voltage Between Phase To Neutral And Current Of That Phase	550.00

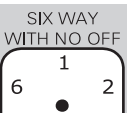
w.e.f. March 2021

CAM OPERATED ROTARY SWITCHES

	SWITCHING	POLE	PROGRAMME	10 A. SC10	16 A. SC16	25 A. SC25	32 A. SC32	40 A. SC40	63 A. SC63	100 A. SC100	200 A. SC100
	ON - OFF	1	SI195	221.00	239.00	260.00	322.00	467.00	520.00	2164.00	2597.00
		2	SI198	265.00	281.00	316.00	384.00	543.00	637.00	2703.00	3243.00
	ON ● ON	3	SI197	294.00	324.00	405.00	472.00	658.00	782.00	3335.00	4002.00
	OFF	4	SI196	313.00	343.00	477.00	566.00	759.00	886.00	3866.00	4640.00
	ON - OFF	1	SI191	221.00	239.00	260.00	322.00	467.00	520.00	2164.00	2597.00
		2	SI192	265.00	281.00	316.00	384.00	543.00	637.00	2703.00	3243.00
	● ON	3	SI199	294.00	324.00	405.00	472.00	658.00	782.00	3335.00	4002.00
	OFF	4	SI194	313.00	343.00	477.00	566.00	759.00	886.00	3866.00	4640.00
	TWO WAY WITH NO - OFF	1	SI037	285.00	301.00	327.00	384.00	552.00	646.00	2806.00	3367.00
		2	SI038	324.00	347.00	437.00	492.00	782.00	903.00	4103.00	4924.00
	2 ● 2	3	SI039	405.00	449.00	570.00	656.00	1026.00	1217.00	5313.00	6376.00
	1	4	SI040	488.00	523.00	637.00	736.00	1202.00	1382.00	6710.00	8052.00
	TWO WAY WITH OFF	1	SI151	285.00	301.00	327.00	384.00	552.00	646.00	2806.00	3367.00
		2	SI152	324.00	347.00	437.00	492.00	782.00	903.00	4103.00	4924.00
	2 ● 1	3	SI153	405.00	449.00	570.00	656.00	1026.00	1217.00	5313.00	6376.00
	OFF	4	SI154	488.00	523.00	637.00	736.00	1202.00	1382.00	6710.00	8052.00
	THREE WAY WITH OFF	1	SI060	324.00	384.00	437.00	508.00	708.00	799.00	2852.00	3422.00
		2	SI080	393.00	467.00	570.00	591.00	1037.00	1150.00	4202.00	5043.00
	3 ● 1	3	SI100	485.00	626.00	759.00	869.00	1371.00	1543.00	5468.00	6562.00
	2	4	SI131	627.00	791.00	911.00	1067.00	1704.00	1898.00	6909.00	8291.00
	FOUR WAY WITH NO OFF	1	SI050	368.00	403.00	467.00	559.00	798.00	911.00	2850.00	3420.00
		2	SI070	472.00	481.00	674.00	789.00	1224.00	1359.00	4400.00	5280.00
	4 ● 2	3	SI090	497.00	720.00	913.00	1044.00	1724.00	1898.00	5796.00	6955.00
	3	4	SI121	730.00	853.00	1093.00	1233.00	2176.00	2404.00	7121.00	8545.00
	FIVE WAY WITH OFF	1	SI062	428.00	476.00	626.00	750.00	936.00	1051.00	0	00.00
		2	SI082	573.00	696.00	886.00	1047.00	1484.00	1709.00	0	00.00
	5 ● 1	3	SI102	715.00	1030.00	1141.00	1346.00	2082.00	2340.00	13465.00	16158.00
	4 ● 2	3	SI102	715.00	1030.00	1141.00	1346.00	2082.00	2340.00	13465.00	16158.00
	SIX WAY WITH NO OFF	1	SI052	439.00	488.00	644.00	776.00	1202.00	1329.00	4186.00	5023.00
		2	SI072	570.00	741.00	1139.00	1419.00	1734.00	1927.00	8347.00	10016.00
	6 ● 2	3	SI092	768.00	1143.00	1244.00	1380.00	2444.00	2785.00	14191.00	17029.00
	SEVEN WAY WITH OFF	1	SI064	477.00	543.00	674.00	789.00	1252.00	1419.00		
		2	SI084	658.00	798.00	1202.00	1419.00	1957.00	2148.00		
	7 ● 1	3	SI104	966.00	1202.00	1431.00	1615.00	2923.00	3255.00		
	EIGHT WAY WITH NO OFF	1	SI054	534.00	596.00	685.00	812.00	1369.00	1619.00		
		2	SI074	708.00	948.00	1214.00	1449.00	2309.00	2593.00		
	8 ● 2	3	SI094	1139.00	1244.00	1564.00	1730.00	3271.00	3602.00		

ROTARY SWITCHES FOR MOTOR DUTY APPLICATIONS
SCI MAKE CAM OPERATED ROTARY SWITCHES SUITABLE FOR SWITCHING CONTROLLING AND STARTING 3 PHASE 440 VOLTS 50Hz SQUIRREL CAGE INDUCTION MOTORS FOR AC3 AND AC4 DUTIES.

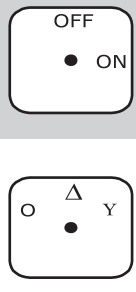
SWITCHING	POLE	AMPS.	TYPE	PROGRAMME	DESCRIPTION	UNIT PRICE
	03	16	SC16	SI003	ON-OFF SWITCH	322.00
	03	25	SC25	SI003	ON-OFF SWITCH	405.00
	03	32	SC32	SI003	ON-OFF SWITCH	476.00
	03	40	SC40	SI003	ON-OFF SWITCH	658.00
	03	63	SC63	SI003	ON-OFF SWITCH	787.00
	03	16	SC16	SI200	SI200	STAR-DELTA SWITCH
	03	25	SC25	SI200	STAR-DELTA SWITCH	658.00
	03	32	SC32	SI200	STAR-DELTA SWITCH	730.00
	03	40	SC40	SI200	STAR-DELTA SWITCH	1316.00
	03	63	SC63	SI200	STAR-DELTA SWITCH	1451.00

FORWARD - OFF - REVERSE SWITCHES

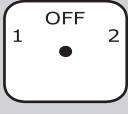
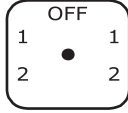
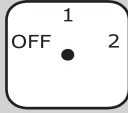
SWITCHING	POLE	AMPS.	TYPE	PROGRAMME	DESCRIPTION	UNIT PRICE
	03	06	SC 6	SI211	THREE POLE REVERSING	219.00
	03	10	SC10	SI211		322.00
	03	16	SC16	SI211		430.00
	03	25	SC25	SI211		488.00
	03	32	SC32	SI211		538.00
	03	40	SC40	SI211		1265.00
	03	63	SC63	SI211		1523.00
	03	25	SC25	SI217	TWO SPEED FORWARD REVERSE SWITCHES	1026.00
	03	25	SC25	SI446	TWO SPEED FORWARD SWITCH IN DIFFERENT PHASE COMBINATION	932.00
	03	25	SC25	SI212	TWO SPEED FORWARD SWITCHES	819.00



w.e.f. March 2021

CHANGEOVER SWITCHES (90° DOUBLE THROW)

SWITCHING	POLE	PROGRAMME	25 AMPS SC25 (Rs.)	32 AMPS SC32 (Rs.)	40 AMPS SC40 (Rs.)	63 AMPS SC63 (Rs.)
	02	SI152CO	529.00	573.00	814.00	1164.00
	03	SI153CO	689.00	736.00	1019.00	1557.00
	04	SI154CO	900.00	945.00	1311.00	1937.00

Additional Price For Sheet Metal Box For 2 Pole Rs. 160.00 For 3 & 4 Pole Rs. 300.00

SWITCHES WITH METAL BOX 60°

	SWITCHING	POLE	PROGRAMME	16 AMPS SC16 (Rs.)	25 AMPS SC25 (Rs.)	32 AMPS SC32 (Rs.)
	Three Pole Reversing (Type SI 211)	03	SI913	736.00	819.00	863.00
	Three Pole On - Off	03	SI244	564.00	673.00	759.00
	Three Pole Reversing	03 03	SI912 SI910	550.00 -----	653.00 -----	688.00 955.00

SPRING RETURN SWITCHES

SWITCHING	POLE	PROGRAMME	DESCRIPTION	16 AMPS SC16 (Rs.)	25 AMPS SC25 (Rs.)
	1	SI351	On-off	334.00	391.00
	2	SI352	With Spring	389.00	477.00
	3	SI353	Return To Off	466.00	610.00
	4	SI354		497.00	715.00
	1	SI361	Double Throw	419.00	488.00
	2	SI362	Spring Return	497.00	658.00
	3	SI363	Both Side To Off	633.00	874.00
	1	SI364	Three Position	419.00	488.00
	2	SI365	With One Position	497.00	658.00
	3	SI369	Spring Return To Off	633.00	874.00
	1	SI371	Two Position	419.00	488.00
	2	SI372	Spring Return	497.00	658.00
	3	SI373	Switches 2 To 1	633.00	874.00
	1	SI300	Stop-start Switch	419.00	488.00
	2	SI388	Spring Return To Centre Position	497.00	658.00



SPRING RETURN SWITCHES FOR CONTROL CIRCUITS (TNC)

SWITCHING	POLE	PROGRAMME	DESCRIPTION	25 AMPS SC25 (Rs.)	32 AMPS SC32 (Rs.)
	2	SI009	2NO + 2NC	695.00	800.00

SPARES FOR ROTARY SWITCHES

S.No.	DESCRIPTION	SIZE in mm.	UNIT PRICE
I. INDICATING PLATES (FRONT PLATES)			
	■ 6 TO 16 AMPS	48 x 48	28.00
	■ 25 & 32 AMPS	64 x 64	36.00
	■ 40 & 63 AMPS	88 x 88	48.00
II. SCRIPT PLATES (MARKING PLATES)			
	■ UP TO 16 AMPS	48 x 48	6.00
	■ 16 TO 32 AMPS	64 x 64	9.00
	■ 40 & 63 AMPS	88 x 88	13.00
III. KNOBS			
	■ Tear Drop For 6 To 16 Amps	48 x 48, 48 x 60	14.00
	■ Tear Drop For 16 To 32 Amps	64 x 64, 64 x 80	26.00
	■ Tear Drop For 40 & 63 Amps	88 x 88	38.00
IV. HANDLES			
	■ Flag Handle For 16 Amps	48 x 48, 48 x 60	14.00
	■ Flag Handle For 25 & 32 Amps	64 x 64, 64 x 80	26.00
	■ Ball Handle For 16 To 32 Amps	64 x 64, 64 x 80	40.00
	■ Ball Handle For 40 & 63 Amps	88 x 88	64.00
	■ Pistol Grip Handle For 16 To 32 Amps	64 x 64, 64 x 80	48.00
	■ Long Handle For 16 To 32 Amps	64 x 64, 64 x 80	48.00
	■ Lever Handle For 40 & 63 Amps	88 x 88	70.00
V. MOUNTING PLATES (FOR REAR MOUNTING)			
	■ 6 TO 16 AMPS	48 x 48	6.00
	■ 25 & 32 AMPS	64 x 64	12.00
	■ 40 & 63 AMPS	88 x 88	18.00

TERMS AND CONDITIONS

1. This supercedes all previous price lists.
2. The prices mentioned in the list are exclusive of GST which shall be charged extra as applicable at the time of dispatch.
3. The prices are on F. O. R. Delhi Basis.
4. Insurance charges shall be extra at actual, if asked for.
5. The prices are subject to change without notice.
6. Our standard terms and conditions applicable to above prices.
7. All disputes are subject to Delhi jurisdiction.
8. All prices are in Indian Rupees.
9. The company reserves the rights to issue amendments, which may arise due to any errors in the price list.

NOTES

A large section of the page containing horizontal dotted lines for writing notes.

w.e.f. March 2021

NOTES

Area for notes with horizontal dotted lines.



AN ISO 9001 : 2015 COMPANY

For details Product Information Contact :

SWITCH CONTROL (INDIA)

A - 5/5, Jhilmil Industrial Area, Delhi-110 095

Email : scidelhi@ndb.vsnl.net.in, info@switchcontrolindia.in

Website : www.switchcontrolindia.in

