

SURAJ[®]

CE
CERTIFIED

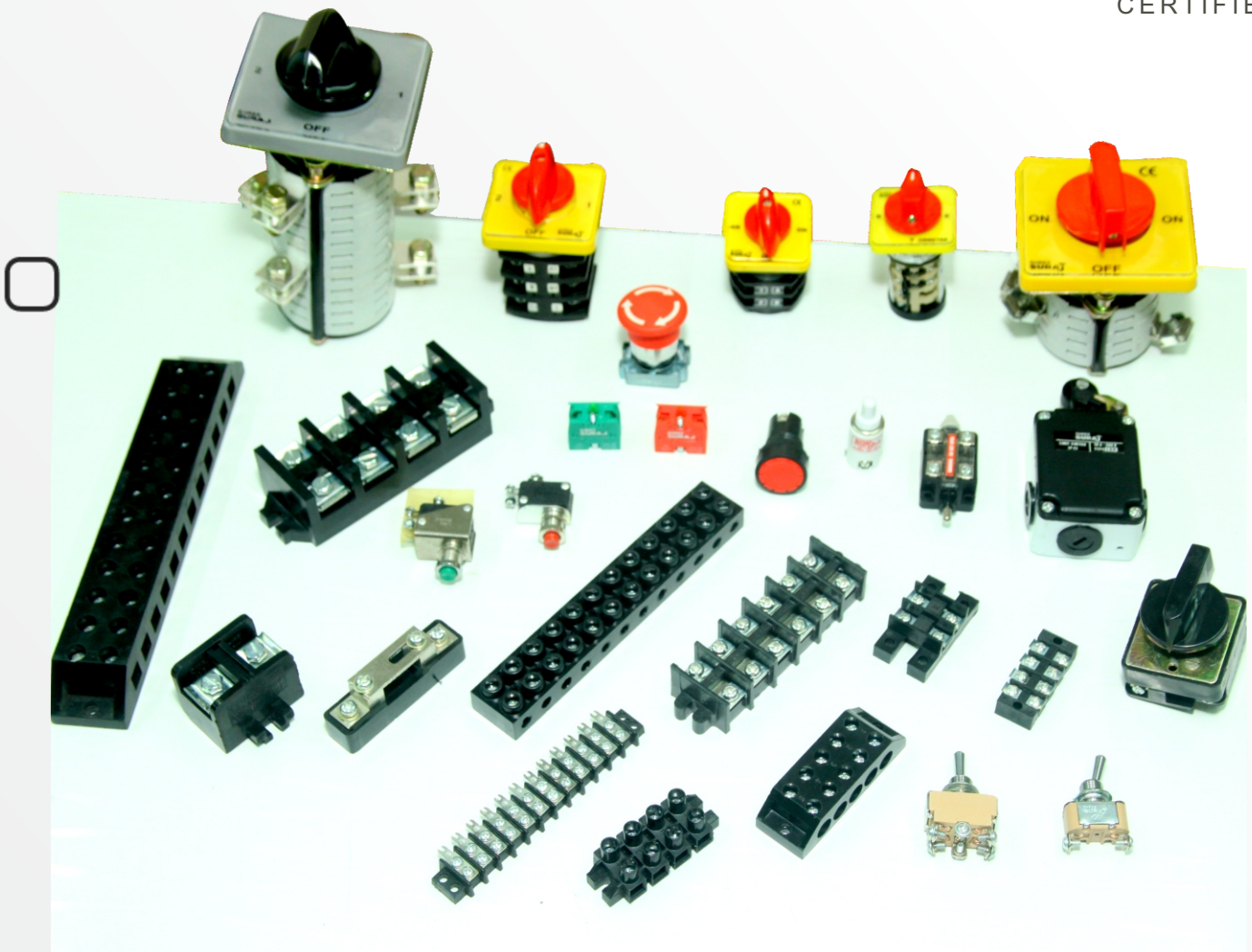

Price list w.e.f. MARCH 2022

TERMINAL BLOCKS

EURO TERMINALS

ROTARY CAM SWITCHES

RIGID TERMINALS

ADD-ON TERMINALS

ROTARY SWITCHES

BARRIER TERMINALS

TOGGLE SWITCHES

NEUTRAL LINKS

SIGNALLING AND CONTROLLING DEVICES

CLOSE TYPE CONNECTORS



CODE NO.	RATING	WAYS	RATE/PC	PACKING
SC 1205	5 AMPS	12 WAY	53.50	25 Nos.
SC 1210	10 AMPS	12 WAY	59.50	25 Nos.
SC 1215	15 AMPS	12 WAY	78.00	20 Nos.
SC 1230	30 AMPS	12 WAY	144.00	15 Nos.
SC 815	15 AMPS	8 WAY	52.70	50 Nos.

**5A,10A,15A & 30A/500V.AC
(BAKELITE) DULY
CUT AND VARNISHED**

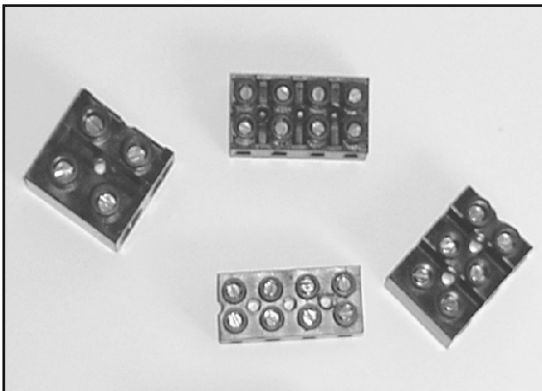

WAYS	5 AMPS	10 AMPS	15 AMPS	30 AMPS
1	9.65	10.65	14.00	24.70
2	9.65	10.65	14.00	24.70
3	14.10	15.60	20.20	36.70
4	18.55	20.55	26.70	48.70
5	23.00	25.50	33.20	60.70
6	27.50	30.50	39.70	72.70
7	31.95	35.50	46.20	84.70
8	36.40	40.50	52.70	96.70
9	40.85	45.50	59.20	108.70
10	45.30	50.50	65.70	120.70
11	53.50	59.50	78.00	144.00



15A/500 V.AC ONE MOULD CONNECTOR

CODE NO.	RATING	WAYS	RATE/PC	PACKING
SC 152	15 A	2 WAYS	14.00	100 NOS

5A,10A,15A & 30A/ 500V.AC (LD)

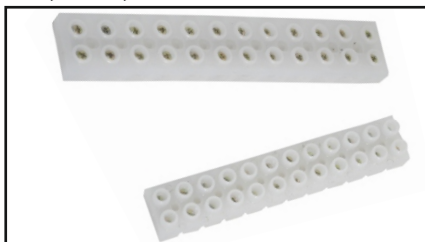

New Introduction →

CODE NO.	RATING	WAYS	RATE/PC	PACKING
SCN 1205	5 AMPS	12 WAY	37.50	25 Nos.
SCN 1206	6 AMPS	12 WAY	48.00	25 Nos.
SCN 1210	10 AMPS	12 WAY	50.00	25 Nos
SCN 1215	15 AMPS	12 WAY	73.50	20 Nos
SCN1230	30 AMPS	12 WAY	140.00	15 NOS

30 A/500 V.AC 'EURO' SERIES TERMINAL BLOCKS



CODE NO.	RATING	WAYS	RATE/PC	PACKING
SET 302	30 AMPS	2 WAY	25.50	50 Nos
SET 303	30 AMPS	3 WAY	36.00	30 Nos.
SET 304	30 AMPS	4 WAY	47.00	30 Nos.

RIGID TYPE CONNECTORS

30A / 500V.AC (BLACK COLOUR)

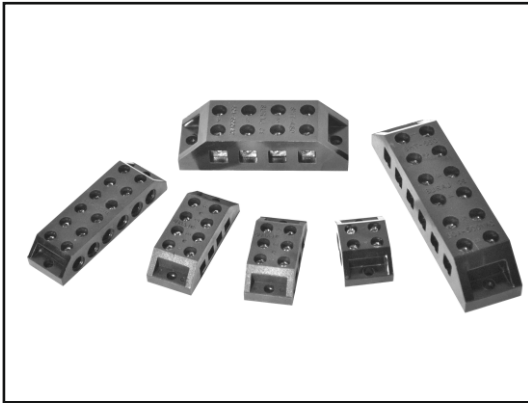

CODE NO.	RATING	WAYS	RATE/PC	PACKING
SHT 2	30 AMPS	2 WAY	25.50	50 Nos.
SHT 3	30 AMPS	3 WAY	36.00	30 Nos.
SHT 4	30 AMPS	4 WAY	47.00	30 Nos.
SHT 5	30 AMPS	5 WAY	57.00	30 Nos.
SHT 6	30 AMPS	6 WAY	69.00	30 Nos.
SHT 8	30 AMPS	8 WAY	108.00	20 Nos
SHT 12	30 AMPS	12 WAY	138.00	15 Nos.

30A / 500V.AC (RED, YELLOW, AND BLUE COLOUR)

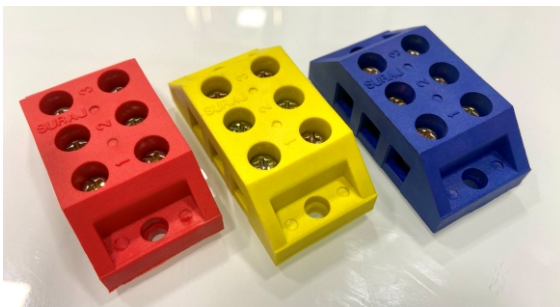

CODE NO.	RATING	WAYS	RATE/PC	PACKING
SHT 2 R/Y/B	30 AMPS	2 WAY	30.00	50 Nos.
SHT 3 R/Y/B	30 AMPS	3 WAY	42.00	30 Nos.
SHT 4 R/Y/B	30 AMPS	4 WAY	53.00	30 Nos.
SHT 5 R/Y/B	30 AMPS	5 WAY	64.00	30 Nos.
SHT 6 R/Y/B	30 AMPS	6 WAY	78.00	30 Nos.

60A / 500V.AC (BLACK COLOUR)



CODE NO.	RATING	WAYS	RATE/PC	PACKING
SHT 260	60 AMPS	2 WAY	99.00	12 Nos
SHT 360	60 AMPS	3 WAY	132.00	6 Nos.
SHT 460	60 AMPS	4 WAY	174.00	6 Nos.
SHT 660	60 AMPS	6 WAY	232.00	6 Nos.
SHT 1260	60 AMPS	12 WAY	484.00	6 Nos.

OPEN TYPE CONNECTORS

15A/500V.AC



CODE NO.	WAYS	RATE /PC	PACKING
SO 215	2 WAY	13.50	100 Nos.
SO 315	3 WAY	17.50	75 Nos.
SO 415	4 WAY	21.50	50 Nos.
SO 515	5 WAY	25.50	50 Nos.
SO 615	6 WAY	30.00	50 Nos.
SO 815	8 WAY	40.00	25 Nos.
SO 1015	10 WAY	48.00	25 Nos.
SO 1215	12 WAY	54.50	25 Nos.

30A/500V.AC

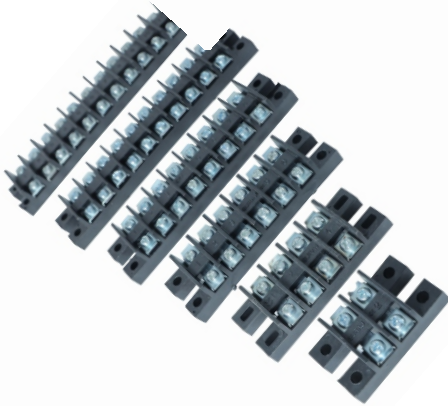

CODE NO.	WAYS	RATE /PC	PACKING
SO 230	2 WAY	24.00	45 Nos.
SO 330	3 WAY	32.00	30 Nos.
SO 430	4 WAY	37.00	30 Nos.
SO 530	5 WAY	50.00	30 Nos.
SO 630	6 WAY	55.50	15 Nos.
SO 830	8 WAY	74.00	15 Nos.
SO 1030	10 WAY	89.00	15 Nos.
SO 1230	12 WAY	100.00	15 Nos.
SO 1230 C-Set (Elevator Connector)	12 WAY	105.00	15 Nos.

60A/500V.AC



CODE NO.	WAYS	RATE /PC	PACKING
SO 260	2 WAY	45.00	12 Nos.
SO 360	3 WAY	65.00	12 Nos.
SO 460	4 WAY	87.00	12 Nos.
SO 660	6 WAY	123.00	12 Nos.
SO 860	8 WAY	180.00	6 Nos.
SO 1260	12 WAY	250.00	6 Nos.

100A/500V.AC (BAKELITE)



CODE NO.	WAYS	RATE /PC	PACKING
SO 2100	2 WAY	180.00	6 Nos
SO 3100	3 WAY	256.00	6 Nos.
SO 4100	4 WAY	304.00	4 Nos.

ADD-ON TYPE TERMINAL BLOCKS

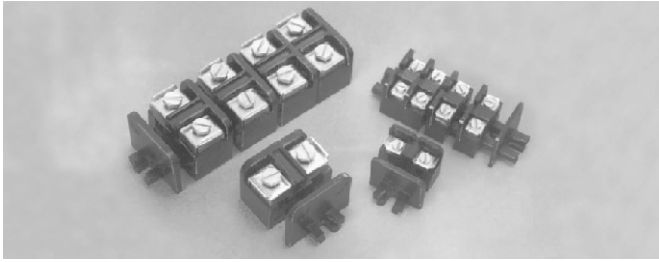

CODE NO.	RATING	WAYS	RATE /PC	PACKING
TB 30	30 AMPS	SINGLE	34.00	50 Nos
TBE 30	30 AMPS	SINGLE	17.00	25 Nos.
TB 100	100 AMPS	SINGLE	89.00	16 Nos.
TBE 100	100 AMPS	SINGLE	23.00	25 Nos.

16/32A, 63A, 100A/500V.AC NEUTRAL LINKS



RATING	RATE	PACKING
16A/32A	28.50	60 Nos.
63A	112.00	30 Nos.
100A	186.00	20 Nos.

SCREWLESS TERMINALS



CODE: SLT205
RATING: 5A/250 V.AC
WAYS: 2
RATE: 8.50
PACKING: 250 NOS



CODE: SLT305
RATING: 5A/250 V.AC
WAYS: 3
RATE: 13.00
PACKING: 250 NOS

FLAMEPROOF LIGHT TERMINAL CONNECTOR

5A/250 V-AC WARDROBE DOOR SWITCHES



CODE: FLP30
RATING: 30A/250 V.AC
WAYS: 1
RATE: 15.00
PACKING: 100 NOS



OPERATION: PUSH-TO-OFF
COLOURS: WHITE ,BLACK and GREY
PRICE: 60.00
PACKING: 15 NOS

Note : 1) Prices are F.O.R. Mumbai 2) HSN CODE: 8536 GST at 18% will be charged extra. (GST rate may change as per govt. notifications)
 3) This price list cancels all our previous price lists.



10A/250V.AC BARRIER TERMINALS

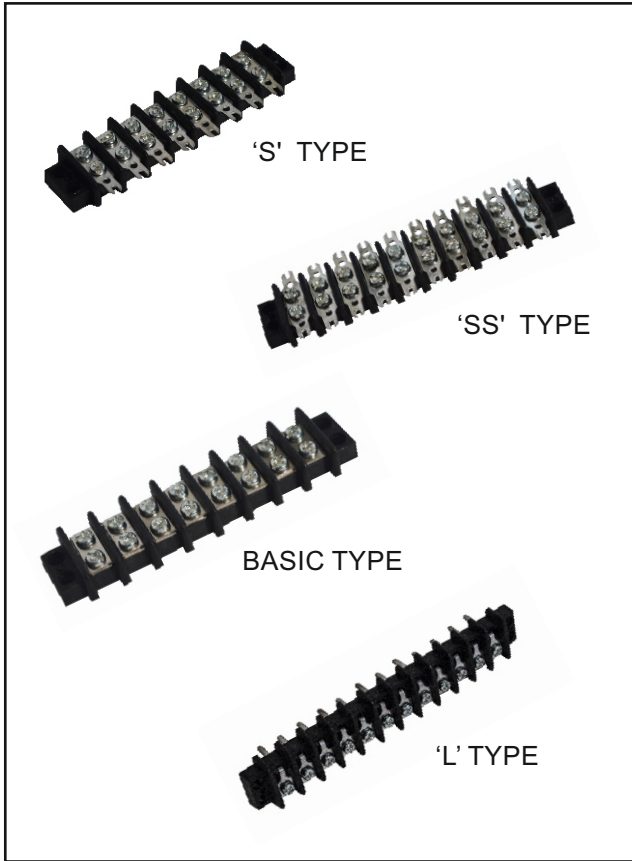

WAYS	BASIC RATE / PC	L. TYPE RATE / PC	S/SS TYPE RATE / PC	PACKING NOS
2	13.00	13.50	19.50	100
3	19.00	19.50	28.00	75
4	24.50	25.00	36.50	50
5	30.00	32.00	45.00	50
6	36.00	36.00	53.00	50
7	41.50	43.00	62.00	60
8	46.50	47.00	70.00	60
9	52.00	53.00	80.00	60
10	56.00	59.00	88.00	30
11	63.00	64.00	96.00	30
12	68.00	69.00	104.00	35
13	74.00	75.00	113.00	30
14	80.00	81.00	122.00	30
15	86.00	88.00	130.00	30
16	91.00	93.00	140.00	30
17	96.50	102.00	148.00	30
18	102.00	110.00	156.00	30
19	108.00	114.00	165.00	25
20	113.00	118.00	174.00	25
21	118.00	123.00	181.00	25
22	123.00	128.00	188.00	25

SIGNALLING AND CONTROLLING DEVICES

10A, 500V.AC push button switch



Type : BTHF
 Operation : 1NO + 1NC
 Colour : Red, Green, Yellow, Blue, White & Black.

Price : Rs. 42.50
 Packing : 25 Nos.

10A/250V.AC Contact Element

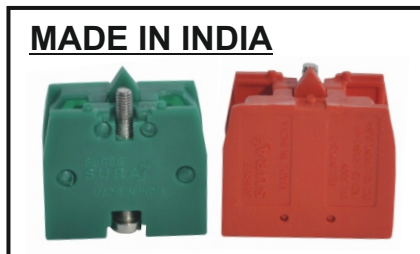

Operation: Normally Open (NO) Price :32.00
 Normally Closed (NC) Packing : 50 Nos

2A/250 V-AC Panel Door Switches



OPERATION : Push to ON-Black Price : 28.00
 Push to OFF-White Packing : 100 Nos

Note : 1) Prices are F.O.R. Mumbai 2) HSN CODE: 8536 GST at 18% will be charged extra. (GST rate may change as per govt. notifications)
 3) This price list cancels all our previous price lists.

10A/250V.AC MICRO SWITCHES

SWITCHES	CODE NO.	ITEM DESCRIPTION	Solder/ Clip Type	Screw Type	STD PACK	SWITCHES	CODE NO.	ITEM DESCRIPTION	Solder/ Clip Type	Screw Type	STD PACK
	001	Basic Type Switch	26.00	26.00	50		009	SILR (Short Integral Lever with Roller)	32.00	32.00	25
	002	FPB (Finger Push Button) Knobs : Red, Black, Green, Yellow, Blue	57.50	57.50	25		010	MILR (Medium Integral Lever with Roller)	34.00	34.00	20
	003	DPPFB (Double Pole Finger Push Button) Knobs : Red, Black, Green, Yellow, Blue	92.00	92.00	20		011	HL (Hinged Lever)	42.50	42.50	25
	004	PB (Push Button) Knobs : Red, Black, Green, Yellow, Blue	57.50	57.50	25		012	HLE (Hinged Lever Extended)	45.50	45.50	25
	005	DPPB (Double Pole Push Button) Knobs : Red, Black, Green, Yellow, Blue	92.00	92.00	20		013	HLR (Hinged Lever with Roller)	57.50	57.50	25
	006	MLPB (Metal DISCONTINUED)	00.00	00.00	00		014	HLER (Hinged Lever Extended with Roller)	59.00	59.00	20
	007	SIL (Short Integral Lever)	31.00	31.00	25		015	PL (Plain Leaf)	44.50	44.50	25
	008	MIL (Medium Integral Lever)	31.50	31.50	25		016	PLR (Plain Leaf with Roller)	46.00	46.00	25

Note : 1) Prices are F.O.R. Mumbai 2) HSN CODE: 8536 GST at 18% will be charged extra. (GST rate may change as per govt. notifications)
3) This price list cancels all our previous price lists.

TOGGLE SWITCHES

SPECIFICATIONS	
OPERATION	Toggle Action
CONTACT RATING (RESISTIVE)	10 Amp-250V AC
SCREW TERMINALS	15 Amp- 28V DC
SOLDER TERMINALS	6 Amp-250V AC 15 Amp- 28V DC
CIRCUITRY	Single and Double Throw 2-3 Position with stay put and momentary contacts.
MECHANICAL & ELECTRICAL LIFE EXPECTANCY	1 lac operations
CONTACT RESISTANCE	20mΩ (Max.)
INSULATION RESISTANCE	20MΩ (Min.)
MOUNTING	Centre Bush with suitable nuts and washer
WEIGHT	Unsealed Single Pole-30 gms. (approx) Double-40 gms. (approx)
THICKNESS OF PANEL	2- 5 mm
TEMPERATURE CATEGORY	40° to + 70°C
OPERATING FORCE	3.5 Kg. (Max)
MOUNTING HARDWARE	UNSEBLED - Supplied with 2 Hexnuts, 1 universal locking ring, which provides mounting of switch in interchanged positions, as per JSS Specification.

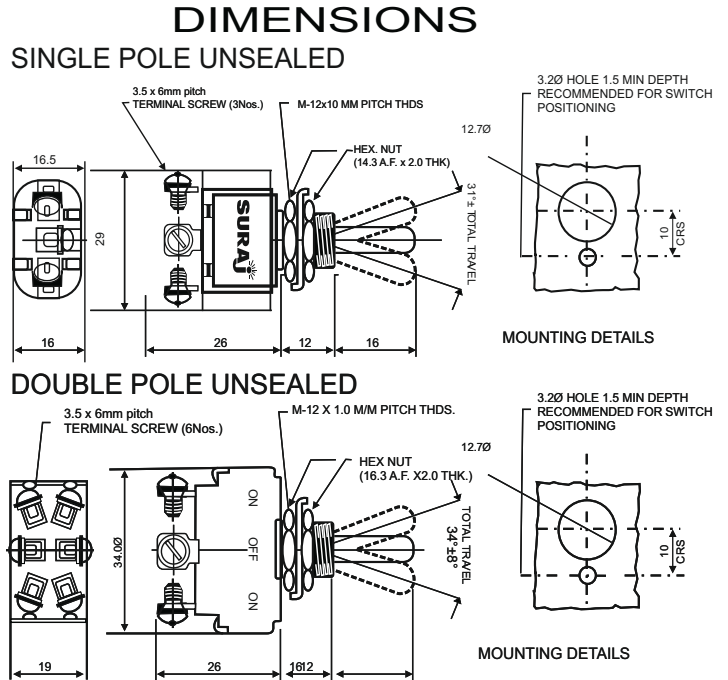

SWITHES ARE ALSO MANUFACTURED WITH SOLDER TERMINALS

6 A /250V AC. SINGLE POLE and DOUBLE POLE SWITCHES

CODE	OPERATION	RATE / PC	PACKING
TS 601	SPST ON-OFF	59.50	25
TS 602	SPDT ON-ON	67.00	25
TS 603	SPDT ON-OFF-ON (Centre Off)	67.00	25
TS 604	SPDT MOM-OFF-MOM (Spring Return)	68.00	25
TS 606	DPST ON- OFF	77.50	20
TS 607	DPDT ON-ON	84.50	20
TS 608	DPDT ON-OFF-ON (Centre Off)	84.50	20
TS 609	DPDT MOM-OFF-MOM (Spring Return)	87.00	20

10 A /250V AC. SINGLE POLE and DOUBLE POLE SWITCHES

CODE	OPERATION	RATE / PC	PACKING
TS 1001	SPST ON-OFF	65.50	25
TS 1002	SPDT ON-ON	69.50	25
TS 1003	SPDT ON-OFF-ON (Centre Off)	69.50	25
TS 1004	SPDT MOM-OFF-MOM (Spring Return)	70.50	25
TS 1006	DPST ON-OFF	79.00	20
TS 1007	DPDT ON-ON	86.00	20
TS 1008	DPDT ON-OFF-ON (Centre Off)	86.00	20
TS 1009	DPDT MOM-OFF-MOM (Spring Return)	89.50	20

15 A /250V AC. SINGLE POLE and DOUBLE POLE SWITCHES

CODE	OPERATION	RATE / PC	PACKING
TS 1501	SPST ON-OFF	78.00	25
TS 1502	SPDT ON-ON	84.00	25
TS 1503	SPDT ON-OFF-ON (Centre Off)	84.00	25
TS 1504	SPDT MOM-OFF-MOM (Spring Return)	84.00	25
TS 1506	DPST ON-OFF	92.00	20
TS 1507	DPDT ON-ON	104.00	20
TS 1508	DPDT ON-OFF-ON (Centre Off)	104.00	20
TS 1509	DPDT MOM-OFF-MOM (Spring Return)	104.00	20

20 A /250V AC. SINGLE POLE and DOUBLE POLE SWITCHES

CODE	OPERATION	RATE / PC	PACKING
TS 2001	SPST ON-OFF	94.00	25
TS 2002	SPDT ON-ON	116.00	25
TS 2003	SPDT ON-OFF-ON (Centre Off)	116.00	25
TS 2004	SPDT MOM-OFF-MOM (Spring Return)	116.00	25
TS 2006	DPST ON-OFF	126.00	20
TS 2007	DPDT ON-ON	172.00	20
TS 2008	DPDT ON-OFF-ON (Centre Off)	172.00	20
TS 2009	DPDT MOM-OFF-MOM (Spring Return)	172.00	20

10A/500 V.AC LIMIT SWITCH



ELEMENT WITH PLASTIC PROTECTIVE COVER

NORMAL ACTION

TYPE	CONTACTS	RATE/PC
E-1	SILVER	124.00
E-2	COPPER	90.00

SNAP ACTION

TYPE	CONTACTS	RATE/PC
E-3	SILVER	136.00
E-4	COPPER	100.00

NORMAL ACTION (LSR) LIMIT SWITCH WITH ALUMINIUM CASTING BODY AND ROLLER ASSEMBLY

SILVER BI-METAL CONTACTS

TYPE	COVER	RATE/PC
MC-1	METAL	348.00
PC-1	ABS PLASTIC	310.00

COPPER CONTACTS

TYPE	COVER	RATE/PC
MC-2	METAL	310.00
PC-2	ABS PLASTIC	270.00

SNAP ACTION (LSRS) LIMIT SWITCH WITH ALUMINIUM CASTING BODY AND ROLLER ASSEMBLY

SILVER BI-METAL CONTACTS

TYPE	COVER	RATE/PC
MC-3	METAL	382.00
PC-3	ABS PLASTIC	360.00

COPPER CONTACTS

TYPE	COVER	RATE/PC
MC-4	METAL	342.00
PC-4	ABS PLASTIC	320.00

STANDARD FEATURES

- 1)CABLE ENTRY FOR CAST METAL HOUSING : PG 11
- 2)DEGREE OF PROTECTON: IP 43
- 3)AMBIENT TEMPERATURE : -40 TO 85 DEGREES
- 4)CONFORMS TO : IS-6875 FOR AC 2 DUTY
- 5) APPLICATIONS : ELEVATORS AND MACHINERY



ROLLER ASSEMBLY

CODE NO	TYPE	RATE/PC
RL	ROLLER	45.00