

ISO 9001  
LL-C (Certification)



RoHS CE

**SURDHI**<sup>®</sup>

*Innovation Throughout...*

Price List - Effective from 01-Aug.-2021









# Contents



CONTROL & SIGNALING DEVICES DIA 22.5mm	1 & 2
CONTROL & SIGNALING DEVICES DIA 22.5mm NO/NC & LED	2
PUSH BUTTON STATION POLYCARBONET & ALLUMINIUM	2
PUSH BUTTON STATION, PANDENT, CANOPY	3
SPARES FOR DIA 22.5mm	3
METAL CLAD PLUG AND SOCKET	4
FUSE FITTING, FUSE BASE	4
FUSE LINK	4 & 5
AUTOMATIC CHANGE OVER SWITCH	5
SINGLE PHASING PREVENTOR, DOOR SWITCH, MCB BOX	5
SOLID STATE BUZER & INDUSTRIAL HOOTER	6
ANALOG METER AC,DC, Hz, SHUNT	6
DIGITAL PANEL METER	7 & 8
JUNCTION BOX	8
CURRENT TRANSFORMERS	9 & 10
TOGGLE SWITCHES	10
CAM OPERATED ROTARY SWITCHES 6A	11
CAM OPERATED ROTARY SWITCHES 6A ASS & VSS, 10A	12
CAM OPERATED ROTARY SWITCHES 16A, 25A, 32A,40A	13
CAM OPERATED ROTARY SWITCHES 63A, 100A	14
PHASE SELECTOR SWITCH, REVERSE FORWARD , STAR DELTA	15
PHASE SELECTOR SWITCH WITH DB, REVERSE FORWARD WITH DB	15
MULTI SOCKET SHEET STEEL ENCLOSURE	16
ROTARY SWITCH- CHANGE OVER SWITCH, SPRING RETURN, TNC	17
SPARES FOR ROTARY SWITCHES	18
ACCESSORIES FOR ONLOAD CHANGE OVER SWITCHES	18
ONLOAD CHANGE OVER SWITCHES, LOAD BREAK SWITCHES	19
BY PASS SWITCHES, SFU	20
TERMINAL BLOCK	20
OIL TIGHT LIMIT SWITCH	INSIDE BACK COVER





**All PRICES ARE IN INR (₹)**

## CONTROL & SIGNALING DEVICES Ø 22.5mm



Description	Cat. No.	Unit Price (₹)
 Flush Actuator (Plastic Body)	SDV-AF-PL	48.00
 Flush Actuator (Metal Body)	SDV-AF	70.00
 Projecting Actuator	SDV-AP	94.00
 Flush Booted Actuator	SDV-AB	104.00
 Push Button with 1 NO & 1 NC Combined	SDV-THF	39.00
<b>Available Colour:</b> R, G, Y, BL, BK, W <b>Std. Packing:</b> 20 Nos.		



Description	Cat. No.	Unit Price (₹)
 Mushroom Key Actuator (without Element) Red Colour	SDV-AKIPL	375.00
 Key Selector Actuator (without Element) 2 & 3 Position	SDV-S2K SDV-S3K	240.00 240.00
<b>Available Colour:</b> BLACK <b>Std. Packing:</b> 10 Nos.		

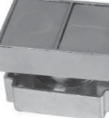

Description	Cat. No.	Unit Price (₹)
 Luminous Twin Actuator (BA-9S Filament Bulb) With series resistance 220V, 110V, 60 V AC or DC 48V, 24V, 12V AC/DC supply.	SDV-DBALTR	260.00
 Luminous Twin Actuator (BA-9S Filament Bulb) Without series resistance 220V, 110V, 60 V, 48V, 24V, 12V AC supply.	SDV-DBALT	260.00
<b>Available Colour:</b> R & G <b>Std. Packing:</b> 6 Nos.		

Description	Cat. No.	Unit Price (₹)
 Luminous Selector Actuator (BA-9S Filament Bulb) (without Element) With series resistance 220V, 110V, 60V AC or DC 48V, 24V, 12V AC/DC supply 2 Position	SDV-2SLALTR	260.00
 Luminous Selector Actuator (BA-9S Filament Bulb) (without Element) With series resistance 220V, 110V, 60V AC or DC 48V, 24V, 12V AC/DC supply 3 Position	SDV-3SLALTR	280.00
 Luminous Selector Actuator (BA-9S Filament Bulb) (without Element) Without series resistance 220V, 110V, 60V, 48V, 24V, 12V AC supply 2 Position	SDV-2SLALT	275.00
 Luminous Selector Actuator (BA-9S Filament Bulb) (without Element) Without series resistance 220V, 110V, 60V, 48V, 24V, 12V AC supply 3 Position	SDV-3SLALT	290.00
<b>Available Colour:</b> R, G, A, Y, BL <b>Std. Packing:</b> 10 Nos.		

Description	Cat. No.	Unit Price (₹)
 Mushroom Actuator 40mm Head	SDV-AM	116.00
 Mushroom Stay-Put Actuator 40mm Head	SDV-AMS	128.00
 Jumbo Mushroom Stay-Put Actuator 60mm Head	SDV-AJMS	200.00
 Jumbo Mushroom Actuator 60mm Head	SDV-AJM	160.00
<b>Available Colour:</b> R, G, Y, BL, BK, <b>Std. Packing:</b> 10 Nos. for AM & AMS / 5 Nos AJMS & AJM		



Description	Cat. No.	Unit Price (₹)
 Selector Actuator (without Element) 2 & 3 Position	SDV-S2P SDV-S3P	130.00 130.00
 Selector Spring Return (without Element) 2 & 3 Position	SDV-S2PS SDV-S3PS	160.00 160.00
<b>Available Colour:</b> BLACK <b>Std. Packing:</b> 10 Nos.		
 Twin Actuator (without Element)	SDV-DB	130.00
<b>Available Colour:</b> R, & G <b>Std. Packing:</b> 10 Nos.		

Description	Cat. No.	Unit Price (₹)
 Luminous Actuator (BA-9S Filament Bulb) (without Element) With series resistance suitable for 220V, 110V, 60V AC or DC, 48V, 24V, 12V AC/DC supply.	SDV-ALTR	182.00
 Luminous Actuator (BA-9S Filament Bulb) (without Element) Without series resistance suitable for 220V, 110V, 60V, 48V, 24V, 12V AC supply.	SDV-ALT	190.00
<b>Available Colour:</b> R, G, A, Y, BL <b>Std. Packing:</b> 10 Nos.		



Description	Cat. No.	Unit Price (₹)
 Pilot Light BA-9S Filament Bulb. with series resistance for 220V, 110V, 60V AC or DC 48V, 24V, 12V AC/DC supply	SDV-PLR	160.00
 Pilot Light BA-9S Filament Bulb. without series resistance for 220V, 110V, 60V, 48V, 24V, 12V AC supply	SDV-PL	160.00
<b>Available Colour:</b> R, G, A, Y, BL <b>Std. Packing:</b> 10 Nos		

## CONTROL & SIGNALING DEVICES Ø 22.5mm

Description	Cat. No.	Unit Price (₹)
 Pilot Light in Barrel Type with Neon Bulb 220V AC-Ø 22.5 mm	SDV-ABN	50.00
 Pilot Light in Barrel Type with Neon Bulb 220V AC-Ø 22.5 mm (Economic)	SDV-ABNE	25.00
 Pilot Light in Barrel Type with Neon Bulb 220V AC-Ø 16 mm (Economic)	SDV-ABNE16	20.00
<b>Available Colour:</b> R, G, Y, BL, BK, W <b>Std. Packing:</b> 20/50 Nos.		

Description	Cat. No.	Unit Price (₹)
 Contact Block 1 NO with SURDHI mark Green Colour	SDV-1	53.00
 Contact Block 1 NC with SURDHI mark Red Colour	SDV-2	53.00
<b>Std. Packing:</b>		50 Nos.

## CONTROL & SIGNALING DEVICES (LED)\*

Description	Cat. No.	Unit Price (₹)
 <b>LED BUZZER WITH INDICATOR -</b> 22.5MM DIA - BARREL TYPE VOLTAGE 220V AC	SDV-BULD	150.00
<b>Std. Packing:</b> 20 Nos.		
 Luminous Actuator with cluster LED and integral circuit suitable for 110V, 240V, 440V AC, 12V, 24V, 48V, 60V, AC/DC supply	SDV-LDALTR	190.00
<b>HSN CODE</b> 8536		
 Luminous Selector with cluster LED and integral circuit suitable for 110V, 240V, 440V AC, 12V, 24V, 48V, 60V AC/DC Supply		
2. Position	SDV-LED2SL	285.00
3. Position	SDV-LED3SL	300.00
<b>Available Colour:</b> R, G, A, Y, W, C, BL <b>Std. Packing:</b> 10 Nos.		
<b>HSN CODE</b> 8536		
Description	Cat. No.	Unit Price (₹)
 Luminous Twin Actuator (without Element) 110V, 240V, 440V AC, 12V, 24V, 48V, 60V AC/DC supply	SDV-LDDBL	275.00
<b>Std. Packing:</b> 6 Nos.		

Description	Cat. No.	Unit Price (₹)
 Multi Voltage LED Indicator in Barrel Type from 12V to 230V AC/DC	SDV-UBLD	115.00
 Pilot Light Led 22.5 mm in Barrel type 110V, 240V AC or DC 440V AC, 12V, 24V, 48V, 60V AC/DC supply.	SDV-ABLD22	82.00
 Pilot Light LED 16mm in Barrel type 220V AC 440V AC, 12V, 24V, 48V, 60V AC/DC supply.	SDV-ABLD16	77.00
 Pilot Light LED 10mm in Barrel type 220V AC	SDV-ABLD10	24.00
 Pilot Light LED 10mm in Barrel type - METAL - 220V AC	SDV-ABLDM10	47.00
 Pilot Light with cluster LED and integral circuit suitable for 110V, 240V AC OR DC, 440V AC, 12V, 24V, 48V, 60V, AC/DC supply.	SDV-LDPLR	160.00
<b>Available Colour:</b> R, G, A, Y, W, C, BL <b>Std. Packing:</b> 20/200/10 Nos.		
<b>HSN CODE</b> 85389000		

Abbreviations : R - Red, G - Green, Y - Yellow, A - Amber, BL - Blue, BK - Black, W - White, C - Clear

## PUSH BUTTON STATION

Std. Packing: 1 No.

In Aluminium Die Cast Enclosure Fitted with Ø 22.5 mm Actuator & 1 NO or 1NC Contact Blocks in each Actuator

FITTED	Description	Cat. No.	Unit Price (₹)
	One Unit	SDV-PBST-1	500.00
	One Unit with (STAYPUT)	SDV-PBST-1A	585.00
	Two Unit	SDV-PBST-2	739.00
	Two Unit with (STAYPUT)	SDV-PBST-2A	886.00
	Three Unit	SDV-PBST-3	969.00
	Four Unit	SDV-PBST-4	1156.00

**PUSH BUTTON STATION - POLY CARBONATE FITTED WITH SDV-THF PUSH BUTTON**

	One Unit	SDV-PBS(P)1	135.00
	Two Unit	SDV-PBS(P)2	209.00
	Three Unit	SDV-PBS(P)3	253.00
	Four Unit	SDV-PBS(P)4	308.00

In Aluminium Die Cast Enclosure without Actuator & Contact Blocks

EMPTY	Description	Cat. No.	Unit Price (₹)
	One Unit	SDV-PBSTMT-1	385.00
	Two Unit	SDV-PBSTMT-2	493.00
	Three Unit	SDV-PBSTMT-3	600.00
	Four Unit	SDV-PBSTMT-4	616.00

**PUSH BUTTON STATION - POLY CARBONATE (EMPTY BOX)**

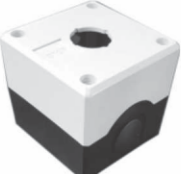
	One Unit	SDV-PBS(P)1 MT	100.00
	Two Unit	SDV-PBS(P)2 MT	131.00
	Three Unit	SDV-PBS(P)3 MT	154.00
	Four Unit	SDV-PBS(P)4 MT	176.00

## PUSH BUTTON STATION

In Cast Aluminium Enclosure Fitted with Ø 22.5 mm Actuator & 1 NO or 1 NC Contact Blocks in each Actuator

Description	Cat. No.	Unit Price (₹)
One Unit	SDV-PS-1	451.00
One Unit with (STAYPUT)	SDV-PS-1A	495.00
Two Unit	SDV-PS-2	660.00
Two Unit with (STAYPUT)	SDV-PS-2A	737.00
Three Unit	SDV-PS-3	913.00
Four Unit	SDV-PS-4	1148.00
Six Unit	SDV-PS-6	1694.00
Eight Unit	SDV-PS-8	2244.00
<b>Std. Packing:</b>	1 No.	



## PANDENT PUSH BUTTON STATION

In Cast Aluminium Enclosure Fitted With Ø 22.5 mm Actuators & 2NO or 2NC Contact Blocks in each Actuator

Description	Cat. No.	Unit Price (₹)
One Unit Single Way	SDV-PPS-1	540.00
Two Unit Single Way	SDV-PPS-2	792.00
Three Unit Single Way	SDV-PPS-3	1078.00
Four Unit Single Way	SDV-PPS-4	1364.00
Six Unit 1 Line / 2 Lines	SDV-PPS-6	1980.00
Eight Unit 1 Line / 2 Lines	SDV-PPS-8	2601.00
Ten Unit 1 Line / 2 Lines	SDV-PPS-10	3190.00
Twelve Unit 1 Line / 2 Lines	SDV-PPS-12	3685.00
<b>Std. Packing:</b>	1 No.	



## PUSH BUTTON STATION WITH CANOPY

In Cast Aluminium Enclosure Fitted with Ø 22.5 mm Actuator & 1 NO or 1 NC Contact Blocks in each Actuator

Description	Cat. No.	Unit Price (₹)
One Unit with (STAYPUT)	SDV-PSC-1A	605.00
Two Unit with one (STAYPUT)	SDV-PSC-2A	835.00
Three Unit one (STAYPUT)	SDV-PSC-3A	1041.00
One Unit Empty	SDV-PSC-1 MT	428.00
Two Unit Empty	SDV-PSC-2 MT	533.00
Three Unit Empty	SDV-PSC-3 MT	566.00
<b>Std. Packing:</b>	1 No.	



## PUSH BUTTON STATION SPECIAL

In Cast Aluminium Enclosure Fitted With Ø 22.5 mm Actuators & 2NO or 2NC Contact Blocks in each Actuator

Description	Cat. No.	Unit Price (₹)
One Unit	SDV-PSS-1	760.00
One Unit with (STAYPUT)	SDV-PSS-1A	844.00
Two Unit	SDV-PSS-2	1197.00
In Cast Aluminium Enclosure Fitted With Ø 22.5 mm two Luminous Actuators & 2NO or 2NC Contact Blocks in each Actuator		
One Unit	SDV-PSS1L	1320.00
Two Unit	SDV-PSS2L	1540.00
<b>Std. Packing:</b>	1 No.	





## SPARES FOR Ø 22.5 MM SERIES 'SDV'

Description	Cat No.	Colour Code	Std. Pkg.	Unit Price (₹)
FILAMENT BULB BA-9S (2.6 WATT Max) in 130V, 48V, 24V, 12V	SDV-BLB		50	48.00
POLYCARBONATE LENSE For Pilot Light	SDV-PLP	(R)(G)(Y)(B)(W)(A)(C)	50	16.00
COMPLETE LENSE ASSEMBLY with Polycarbonate				
Lenze Suitable For Pilot Light without carrier	SDV-PLCP	(R)(G)(Y)(B)(W)(A)(C)	20	59.00
COMPLETE LENSE ASSEMBLY with Polycarbonate				
Lenze & Ring Suitable for Luminous Actuator without carrier	SDV-ALTCPS	(R)(G)(Y)(B)(W)(A)(C)	20	89.00
ADAPTOR FOR ASSEMBLY of Ø 22.5 in Ø 30.5 mm.	SDV-ADP		20	28.00
SPARE BOOT SUITABLE for Booted Button	SDV-ABB	(R)(G)(Y)(B)(C)	50	32.00
On, off, reverse, forward legends Plastic	SDV-IP	(BL)	20	12.00
Luminous Twinh Button Top[ without carrier	SV-DBT	(R)(G)	20	106.00
Legend Plate Plastic (Emergency, Stop)	SDV-IIP	(Y)	20	15.00
Luminous Selector Top without carrier	SDV-SLT	(R)(G)(Y)(B)(W)(A)(C)	20	140.00
Hole Closer (Plastic)	SDV-HC		100	20.00
On, Off, reverse, forward legends Metal	SDV-IPM		20	13.00





**METAL CLAD PLUGS & SOCKETS (ALUMINIUM DIE CAST)**

PLUG	Description	Cat. No.	Unit Price (₹)
	10 Amp. 2 Pole +Earth, 250V	SDV-DP 10	99.00
	20 Amp. 2 Pole +Earth, 250V	SDV-DP 20	116.00
	20 Amp. 3 Pole +Earth, 440V	SDV-TP 20	160.00
	30 Amp. 3 Pole +Earth, 440V	SDV-TP 30	303.00
SOCKET			
	10 Amp. 2 Pole +Earth, 250V	SDV-DS 10	110.00
	20 Amp. 2 Pole +Earth, 250V	SDV-DS 20	131.00
	20 Amp. 3 Pole +Earth, 440V	SDV-TS 20	192.00
	30 Amp. 3 Pole +Earth, 440V	SDV-TS 30	335.00
<b>Std. Packing:</b>		20A-2P = 20PCS., 20A-3P = 20PCS., 30A-3P=10PCS.	

**PLUG & SOCKETS IN SHEET STEEL ENCLOSURE (WITHOUT MCB)**

Powder Coated With Neutral Link With Plug & Socket

	Description	Cat. No.	Unit Price (₹)
	10 Amp. 2Pole+Earth, 250V	SDV-DPSB10	480.00
	20 Amp. 2Pole+Earth, 250V	SDV-DPSB20	556.00
	20 Amp. 3Pole+Earth, 440V	SDV-TPSB20	1012.00
	30 Amp. 3Pole+Earth, 440V	SDV-TPSB30	1405.00
	<b>Std. Packing:</b>		1 No.

**BAKELITE MOULDED FUSE FITTINGS**

Confirms to IS : 13703, IEC 269 - WITHOUT FUSE LINK

	Description	Cat. No.	Unit Price (₹)
	20 Amp. Front Connections	SDV-F-20	96.00
	20 Amp. Bus Bar Connections	SDV-B-20	116.00
	32 Amp. Front Connections	SDV-F-32	171.00
	32 Amp. Bus Bar Connections	SDV-B-32	218.00
	63 Amp. Front Connections	SDV-F-63	264.00
	63 Amp. Bus Bar Connections	SDV-B-63	330.00
	125 Amp. Front Connections	SDV-F-125	577.00
	125 Amp. Bus Bar Connections	SDV-B-125	715.00
<b>Std. Packing:</b>		10 Nos. / for 125 Amp. 3 Nos	

**DIN RAIL-MOUNTED FUSE CARRIER-POLYAMIDE(UNDREAKABLE)**

WITHOUT FUSE LINK

	Description	Cat. No.	Unit Price (₹)
	20 AMP. Front Connections	SDV-PL-20	80.00
	32 AMP. Front Connections	SDV-PL-32	91.00
	<b>Std. Packing:</b>		10 Nos.

**HRC FUSE BASE OPEN TYPE (BAKELITE)**

	Description	Cat. No.	Unit Price (₹)
	125 Amp. Fuse Base	SDV-OB-125	176.00
	250 Amp. Fuse Base	SDV-OB-250	451.00
	400 Amp. Fuse Base	SDV-OB-400	737.00
	630 Amp. Fuse Base	SDV-OB-630	1001.00
<b>Std. Packing:</b>		3 Nos.	

**HRC FUSE BASE OPEN TYPE (DMC)**

	Description	Cat. No.	Unit Price (₹)
	125 Amp. Fuse Base	SDV-OD-125	187.00
	250 Amp. Fuse Base	SDV-OD-250	506.00
	400 Amp. Fuse Base	SDV-OD-400	792.00
	630 Amp. Fuse Base	SDV-OD-630	1100.00
<b>Std. Packing:</b>		3 Nos.	

**FUSE LINKS (TYPE SDV-HR) 415V, 50Hz. (Size 14x51)**

Confirm to IS : 13703 IEC 269

	Description	Cat. No.	Unit Price (₹)
	2, 4, 6, 8, 10, 16, 20, 25, 32 Amp. Fuse Link	SDV-HR-002-032	80.00
	36, 40, 50, 63 Amp.	SDV-HR-036-063	100.00
<b>Std. Packing:</b>		20 Nos.	

**HRC FUSE LINKS OFF SET TAGS (CLIP IN TYPE)**

415 V AC Confirm to IS : 13703 IEC 269

	Description	Cat. No.	Unit Price (₹)
	2, 4, 6, 8, 10, 16, 20, 25, 32 Amp. Fuse Link	SDV-NS	50.00
<b>IS SIZE F1</b>			
<b>Std. Packing:</b>		20 Nos.	

**HBC FUSE LINKS OFF SET TAGS (2-HOLE FIXING)**

415 V AC Confirm to IS : 13703 IEC 269

Description	Cat. No.	Unit Price (₹)	Std. Packing
6, 10, 16, 20, 25, 32 Amp.	SDV-TIA	83.00	10 Pcs.
35, 40, 50, 63 Amp.	SDV-TIS	90.00	10 Pcs.
80, 100 Amp.	SDV-TSD	176.00	6 Pcs.
80, 125 Amp.	SDV-TCP	184.00	6 Pcs.
125, 160, 200 Amp.	SDV-FP	275.00	3 Pcs.

**HBC FUSE LINKS CENTRAL TAGS (2-HOLE FIXING)**

415 V AC Confirm to IS : 13703 IEC 269

Description	Cat. No.	Unit Price (₹)	Std. Packing
80, 100, 125	SDV-TSDC	226.00	6 Pcs.
125, 160, 200 Amp.	SDV-SF	330.00	3 Pcs.
250, 300, 315 Amp.	SDV-SK	424.00	3 Pcs.
355, 400 Amp.	SDV-TSMS	770.00	1 Pcs.
500, 630 Amp.	SDV-TTM	1375.00	1 Pcs.

**HRC FUSE LINKS DIN TYPE (Size 00) Breaking Capacity 80 kA**

415V AC Confirm to IS : 13703 IEC 269

Description	Cat. No.	Unit Price (₹)
6 Amp., 10 Amp., 16 Amp. 20 Amp., 25 Amp., 32 Amp. 50 Amp., 63 Amp., 80 Amp. 100 Amp., 125 Amp., 160 Amp.	SDV-DN-006 to 160	215.00

Std. Packing: 6 Nos.

**HRC FUSE LINKS DIN TYPE (Size 000) Breaking Capacity 120 kA**

415V AC Confirm to IS : 13703 IEC 269

Description	Cat. No.	Unit Price (₹)
6 Amp., 10 Amp., 16 Amp. 20 Amp., 25 Amp., 32 Amp. 50 Amp., 63 Amp., 80 Amp. 100 Amp., 125 Amp.,	SDV-DN-006 to 125	215.00

Std. Packing: 6 Nos.

**HRC FUSE LINKS DIN TYPE (Size 01) Breaking Capacity 80 kA**

415V AC Confirm to IS : 13703 IEC 269

Description	Cat. No.	Unit Price (₹)
32 Amp., 50 Amp., 63 Amp. 80 Amp., 100 Amp., 125 Amp. 160 Amp., 200 Amp., 250 Amp.	SDV-DN-032 to 250	370.00

Std. Packing: 3 Nos.

**HRC FUSE LINKS DIN TYPE (Size 02) Breaking Capacity 80 kA**

415V AC Confirm to IS : 13703 IEC 269

Description	Cat. No.	Unit Price (₹)
200 Amp., 250 Amp. 315 Amp., 400 Amp.	SDV-DN-200 to 400	605.00

Std. Packing: 3 Nos.

**HRC FUSE LINKS DIN TYPE (Size 03) Breaking Capacity 80 kA**

415V AC Confirm to IS : 13703 IEC 269

Description	Cat. No.	Unit Price (₹)
400 Amp., 500 Amp. 630 Amp.	SDV-DN-400 to 630	990.00

Std. Packing: 1 Nos.

**Automatic Changeover Switch**

Rating : 32Amp,  
Volts : 220/240VAC 50Hz,  
Phase : Single.

Cat. No.	Unit Price (₹)	Std. Packing
SDV-ACS32	2200.00	1 Pcs.



**Single Phasing Preventor**

This module provides protection against single phasing, reverse phasing and unbalance supply and it is auto reset and gives 1NO output contact suitable for any HP/KW rating monoblock pumps.

This module provides protection against single phasing, reverse phasing, unbalanced supply and it is auto reset, 1 NO output contact suitable for any HP/KW rating monoblock pumps **Pre-wired terminals** for easy connections.

Cat. No.	Unit Price (₹)	Std. Packing
SDV-VSP2	580.00	10 Pcs.
SDV-VSP3	580.00	10 Pcs.

HSN CODE 85381010

**MCB BOX  
1 POLE  
AND  
2 POLE  
(Plastic Body)**

₹ 33.00 Std. Packing - 100PCs.



**PANEL DOOR SWITCHES**

Std. Packing - 25PCs.

Description	Catalogue No.	Unit Price (₹)
Door Switch push to off 2 Amp. 250V <i>White</i>	SDV-DSW	36.00
Door Switch push to on 2 Amp. 250V <i>Black</i>	SDV-DSB	36.00

**LED BUZZER WITH INDICATOR AND INDUSTRIAL HOOTER**

Description	Cat. No.	Unit Price (₹)
<b>LED BUZZER WITH INDICATOR -</b> 22.5MM DIA - BARREL TYPE VOLTAGE 220V AC	SDV-BULD	150.00
<b>Std. Packing: 20 No.</b>		
<b>INDUSTRIAL HOOTER -</b> In ABS Housing suitable for 220V, 110V, 48V, 24V, 12V AC	SDV-HA	750.00
HSN CODE 85311010		
In ABS Housing suitable for 220V, 110V, 48V, 24V, 12V DC	SDV-HD	935.00
<b>Std. Packing: 1 No.</b>		

Range :- More than 50mtrs. easily audible

**SOLID STATE BUZZER & ELECTRONIC HOOTER (96x96 sq. mm)**

Description	Cat. No.	Unit Price (₹)
<b>Buzzer Multi-tone - MULTI Voltage</b> Voltage Rating - 12V, 24V, AC/DC 60V to 265V AC/DC	SDV-BU96	750.00
<b>SINGLE TONE</b> In ABS Housing suitable for 60V-260V AC/DC 24V, 12V DC	SDV-BA SDV-BD	600.00 560.00
<b>MULTI TONE</b> In ABS Housing suitable for 60V-260V AC/DC 24V, 12V DC	SDV-BAM SDV-BDM	655.00 600.00

Range :- More than 50mtrs. easily audible

**Std. Packing: 1 No.**

**AC PANEL METER (NEEDLE TYPE) ANALOG**

Description	Cat. No.	Unit Price (₹)
15V-300V	SR-96V	330.00
500V-600V	SR-96V	340.00
15V-500V SLIDING	SR-96VS	390.00
Direct upto 30Amp.	SR-96A	340.00
Direct 50,60 Amp.	SR-96A	360.00
Direct 100Amp.	SR-96A	390.00
(CT OPERATED) CTR / 5Amp.	SR-96A	340.00
(CT OPERATED) CTR / 5Amp.(SLIDING)	SR-96AS	390.00

**Std. Packing: 10 No.**

Description	Cat. No.	Unit Price (₹)
15V-300V	SR-72VN	250.00
500V-600V	SR-72VN	260.00
Direct upto 30Amp.	SR-72AN	260.00
Direct 50,60 Amp.	SR-72AN	285.00
(CT OPERATED) CTR / 5Amp.	SR-72AN	260.00

**Std. Packing: 10 Nos.**

**FREQUENCY METER**

Description	Cat. No.	Unit Price (₹)
Suitable for 110V, 230V & 440V AC operations and available in 47-50-53Hz	SR-72FR	510.00
and 45-50-55 Hz.	SR-96FR	520.00

**Std. Packing: 10 No.**

**MOVING COIL DC PANEL METER (NEEDLE TYPE)**

Description	Cat. No.	Unit Price (₹)
1Amp. to 5000Amp.	SR-72AD	460.00
Upto 600 Volt.	SR-72VD	460.00
1Amp. to 5000 Amp.	SR-96AD	530.00
Upto 600Volt.	SR-96VD	530.00

**Std. Packing: 10 Nos.**

**SHUNT**

Description	Unit Price (₹)
10 to 30 Amp.	264.00
50 Amp.	304.00
75 Amp.	396.00
100 Amp.	528.00
150 Amp.	568.00
200 Amp.	737.00
250 Amp.	975.00
300 Amp.	1230.00
400 Amp.	1770.00
500 Amp.	2106.00
600 Amp.	2460.00
700/750 Amp.	2986.00
800 Amp.	3168.00



Description	Unit Price (₹)
1000 Amp.	3564.00
1200 Amp.	3828.00
1500 Amp.	4356.00
1600 Amp.	5016.00
1800 Amp.	5544.00
2000 Amp.	6072.00
2500 Amp.	6732.00
3000 Amp.	7260.00
4000 Amp.	10032.00
5000 Amp.	12012.00
6000 Amp.	23232.00



**Std. Packing: 25 No.**



## DIGITAL PANEL METER (DPM)

### MECHANICAL INSTALLATION

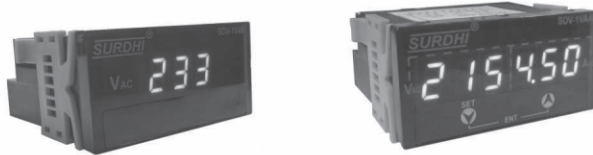

Size : 96x96 Sq.mm

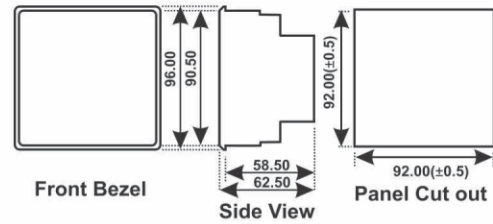

Size : 48x96 Sq.mm

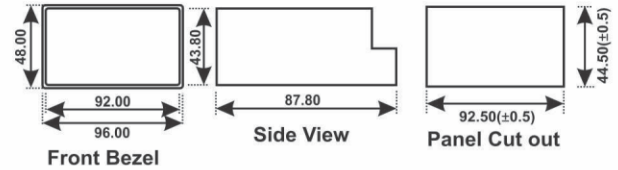

Size : 72x72 Sq.mm

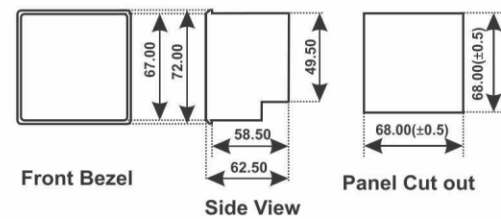

Note : All dimensions are in mm.

Description	Size (Sq.mm)	CAT. No.	Unit Price (₹)
-------------	--------------	----------	----------------

### •Digital Voltmeter (ACTrue RMS)

VOLTMETER AC (Single Phase)	96x96	SDV-1V96	690.00
Measurement Range : Voltage(True RMS) : 10V-700VAC	48x96	SDV-1V48	690.00
Wiring Input : 1Ø - 2 wire and 2Ø - 2 wire. Auxilliary Input : 230 VAC	72x72	SDV-1V72	730.00

VOLTMETER AC (3 Phase)	96x96	SDV-3V96	950.00
Measurement Range : Voltage(True RMS) : 10V-700VAC	48x96	SDV-3V48	950.00
Wiring Input : 3Ø - 4 wire , Inbuilt Volt Selector Switch (VSS). Auxilliary Input : 230 VAC			

VOLTMETER AC (3 Phase on 3 Display)	96x96	SDV-3V3D96	1140.00
Measurement Range : Voltage(True RMS) : 10V-700VAC			
Wiring Input : 3Ø - 4 wire. Auxilliary Input : 230 VAC			

### •Digital Ammeter (ACTrue RMS)

AMMETER AC (Single Phase)	96x96	SDV-1A96	690.00
Measurement Range : Current(True RMS) : 50mA-5A AC(6A max.)	48x96	SDV-1A48	690.00
CT Ratio : Programmable. Auxilliary Input : 230 VAC	72x72	SDV-1A72	730.00

AMMETER AC (3 Phase)	96x96	SDV-3A96	950.00
Measurement Range : Current(True RMS) : 30mA-5A AC(6A max.)	48x96	SDV-3A48	990.00
CT Ratio : Programmable, Inbuilt Ampere Selector Switch (ASS). Auxilliary Input : 230 VAC			

AMMETER AC (3 Phase on 3 Display)	96x96	SDV-3A3D96	1140.00
Measurement Range : Current(True RMS) : 30mA-5A AC(6A max.)			
CT Ratio : Programmable. Auxilliary Input : 230 VAC			

## •Digital VA (Volt-Amp combined) Meter(AC True RMS)

Description	Size (Sq.mm)	CAT. No.	Unit Price (₹)
<b>VA (Volt-Amp) METER AC - Single Phase</b>	96x96	SDV-1VA96	890.00
Measurement Range : Voltage(True RMS) : 10V-700VAC , Current(True RMS) : 30mA-5A AC(6A max.), CT Ratio : Programmable	48x96	SDV-1VA48	890.00
	72x72	SDV-1VA72	930.00

<b>VA (Volt-Amp) METER AC - 3 Phase</b>	96x96	SDV-3VA96	1150.00
Measurement Range : Voltage(True RMS) : 10V-700VAC , Current(True RMS) : 30mA-5A AC(6A max.), CT Ratio : Programmable			



## •Digital Frequency Meter

FREQUENCY METER	Size (Sq.mm)	CAT. No.	Unit Price (₹)
Measurement Range : 10.0 TO 88.0Hz. Range of Voltage for which the frequency to be measured : 50V-700VAC. Auxilliary Input : 230 VAC.	96x96	SDV-FR96	880.00
	48x96	SDV-FR48	880.00
	72x72	SDV-FR72	920.00

## •Digital VAF (Volt-Amp-Frequency combined) Meter (AC True RMS)

<b>VAF (Volt-Current-Freq) METER 3-Phase</b>	96x96	SDV-VAF96	1320.00
Measurement Range : Voltage(True RMS) : 10V-325VAC (VL-N), 19V - 563VAC (VL-L), Current(True RMS) : 30mA-5A AC(6A max.) Frequency : 10.0Hz. to 88.0Hz, RPM : 80-10560 RPM and Run Hr.: 0 - 99999.9 Hr. Wiring Input : 3Ø - 4 wire and 1Ø - 2 wire.,CT/PT Ratio : Programmable.			



Note :- Auxiliary Supply for above articles by default is 230V AC 50 Hz. Also can be customized as per demand.

## JUNCTION BOX - CAST ALUMINIUM



### SIZE :-

- 250X250X140MM WITH CANOPY
- 225X160X120MM 2 PUSH BUTTON SPACE WITH CANOPY
- 205X130X90MM WINDOW
- 150X150X75MM 1 PUSH BUTTON SPACE

### SIZE :-

- 225X125X120MM 2 PUSH BUTTON SPACE WITH CANOPY
- 185X125X120MM 1 WAY CANOPY
- 320X295X70MM
- 150X110X85MM
- 225X190X120 3 PUSH BUTTON SPACE

Effective from - 01-08-2021

**RCT SERIES (Polycarbonate Housing- Ring Type) CURRENT TRANSFORMER**

Description	R. Burden	ID	OD	Unit Price (₹)	
				CL - 1.0	
30/5A	1.5VA	30	95.5	370.00	
30/5A	5VA	30	95.5	385.00	
40,50,60/5A	5VA	30	95.5	370.00	
75	5VA	30	95.5	375.00	
100/5A	5VA	30	95.5	375.00	
150/5A	5VA	30	95.5	380.00	
200/5A	5VA	50	115	385.00	
250/5A	5VA	50	115	385.00	
300/5A	5VA	50	115	398.00	
400/5A	5VA	50	115	410.00	
500/5A	5VA	50	115	425.00	
600/5A	5VA	50	115	440.00	

**Note :-** Customized CT with different Accuracy Class are also available on order.

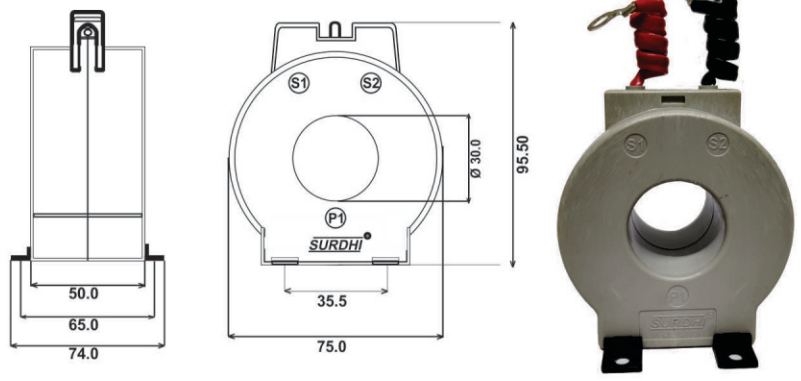

- Features :**
- Sealable Terminal
  - Panel Mount (With Clamp)
  - Accuracy : Class 1

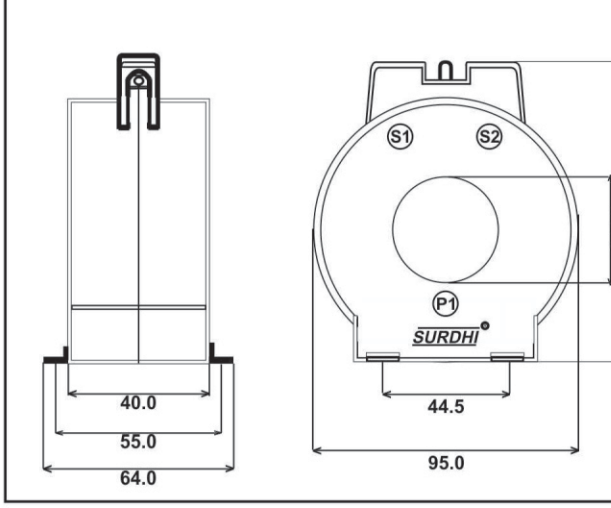

**Note :-** All Dimensions are in mm

**CURRENT TRANSFORMERS (TAPE WOUND)**

Description	R. Burden	ID	OD	Unit Price (₹)	
				CL - 1.0	CL - 0.5
10, 20, 30/5A	1.5VA	33	77	270.00	540.00
40,50,60/5A	5VA	33	77	260.00	585.00
75,100/5A	5VA	33	77	270.00	585.00
125,150/5A	5VA	33	77	281.00	585.00
200/5A	5VA	33	77	294.00	590.00
250/5A	10VA	33	77	308.00	670.00
300/5A	10VA	55	93	315.00	685.00
400/5A	15VA	55	93	325.00	790.00
500/5A	15VA	55	93	343.00	810.00
600/5A	15VA	55	93	364.00	810.00
700/800/5A	15VA	102	139	445.00	850.00
1000/5A	15VA	102	139	477.00	880.00
1200/5A	15VA	102	139	536.00	920.00
1600/5A	15VA	117	162	601.00	1020.00
2000/5A	15VA	117	162	645.00	1150.00
2500/5A	15VA	130	165	716.00	1285.00

**Note :-** Customized CT with different ID and ratings are also available on order.

Current Transformer With Iron Clamp Rs. 30/- to be Added Extra on list Price. with Brass Screw Rs. 30/- to be Added Extra on list Price.



**CURRENT TRANSFORMERS (RESIN CAST)**

Std. Packing: **3 Nos.**

Tested & Passed By  
**ERDA, Vadodara**

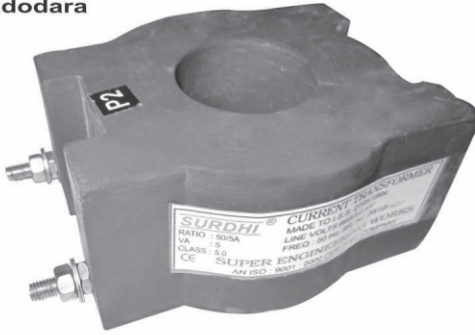

Description	Accuracy Class	R. Burden	Unit Price (₹)
100, 125, 150, 200/5A	1.0	5VA	695.00
250/5A	1.0	10VA	730.00
300/5A	1.0	10VA	765.00
400/5A	1.0	15VA	782.00
500, 600/5A	1.0	15VA	793.00
700, 800/5A	1.0	15VA	805.00
1000/5A	1.0	15VA	851.00
1200/5A	1.0	15VA	894.00
1500/A	1.0	15VA	1006.00
1600/5A	1.0	15VA	1117.00

Tested & Passed By  
**ERDA, Vadodara**

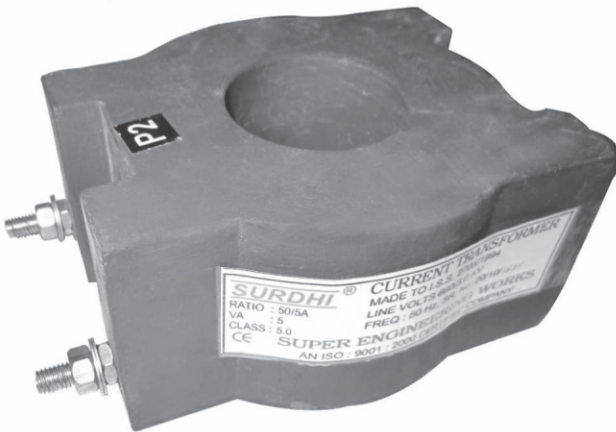

Description	Accuracy Class	R. Burden	Unit Price (₹)
100, 125, 150, 200/5A	0.5	5VA	1046.00
250/5A	0.5	5VA	1046.00
100, 125, 150, 200/5A	0.5	15VA	1230.00
250/5A	0.5	15VA	1230.00
300/5A	0.5	15VA	1230.00
400/5A	0.5	15VA	1230.00
500, 600/5A	0.5	15VA	1144.00
800/5A	0.5	15VA	1181.00
1000/5A	0.5	15VA	1230.00
1200/5A	0.5	15VA	1353.00
1500/A	0.5	15VA	1476.00
1600/5A	0.5	15VA	1537.00



**TOGGLE SWITCHES**

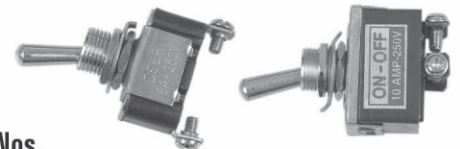

Std. Packing : 25 Nos.

Std. Packing : 20 Nos.

Description	Code	Amp.	Unit Price (₹)
SPST (ON-OFF)	601	6A	60.00
SPDT (ON-ON)	602	6A	62.00
SPDT (ON-OFF-ON)	603	6A	65.00
SPDT MOM one side {ON}-OFF-ON	604	6A	67.00
SPDT MOM both side {ON}-OFF-{ON}	605	6A	69.00
SPST (ON-OFF)	1001	10A	62.00
SPDT (ON-ON)	1002	10A	67.00
SPDT (ON-OFF-ON)	1003	10A	68.00
SPDT MOM one side {ON}-OFF-ON	1004	10A	72.00
SPDT MOM both side {ON}-OFF-{ON}	1005	10A	75.00
SPST (ON-OFF)	1501	15A	80.00
SPDT (ON-ON)	1502	15A	92.00
SPDT (ON-OFF-ON)	1503	15A	95.00
SPDT MOM one side {ON}-OFF-ON	1504	15A	103.00
SPDT MOM both side {ON}-OFF-{ON}	1505	15A	106.00
SPST	2001	20A	109.00
SPDT ON-ON	2002	20A	128.00
SPDT (ON-OFF-ON)	2003	20A	132.00
SPDT MOM one side {ON}-OFF-ON	2004	20A	140.00
SPDT MOM both side {ON}-OFF-{ON}	2005	20A	142.00

Description	Code	Amp.	Unit Price (₹)
DPST (ON-OFF)	2601	6A	73.00
DPDT (ON-ON)	2602	6A	80.00
DPDT (ON-OFF-ON)	2603	6A	82.00
DPDT MOM one side {ON}-OFF-ON	2604	6A	90.00
DPDT MOM both side {ON}-OFF-{ON}	2605	6A	92.00
DPST (ON-OFF)	2101	10A	80.00
DPDT (ON-ON)	2102	10A	89.00
DPDT (ON-OFF-ON)	2103	10A	92.00
DPDT MOM one side {ON}-OFF-ON	2104	10A	100.00
DPDT MOM both side {ON}-OFF-{ON}	2105	10A	105.00
DPST (ON-OFF)	2151	15A	109.00
DPDT (ON-ON)	2152	15A	136.00
DPDT (ON-OFF-ON)	2153	15A	140.00
DPDT MOM one side {ON}-OFF-ON	2154	15A	147.00
DPDT MOM both side {ON}-OFF-{ON}	2155	15A	151.00
DPST (ON-OFF)	2020	20A	144.00
DPDT (ON-ON)	2021	20A	200.00
DPDT (ON-OFF-ON)	2022	20A	205.00
DPDT MOM one side {ON}-OFF-ON	2023	20A	225.00
DPDT MOM both side {ON}-OFF-{ON}	2024	20A	228.00

# Shock Proof

First time launch from Surdhi

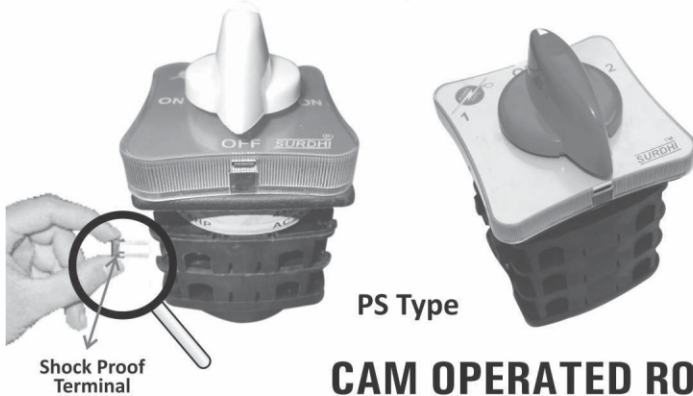

PS Type



SE Type

## CAM OPERATED ROTARY SWITCHES 6 Amps.

Switching	Pole	Prog. No.	Unit (₹) Price SE	Unit (₹) Price PS
ON-OFF (60°)	1	001	106.00	122.00
OFF	2	002	126.00	145.00
ON	3	003	138.00	159.00
	4	004	181.00	208.00
TWO WAY NO-OFF (90°)	1	037	132.00	152.00
1	2	038	176.00	203.00
2 • 2	3	039	209.00	240.00
1	4	040	275.00	316.00
TWO WAY WITH OFF (60°)	1	025	126.00	145.00
OFF	2	026	171.00	197.00
1 • 2	3	027	204.00	235.00
	4	028	269.00	310.00
TWO WAY WITH OFF (90°)	1	151	125.00	144.00
OFF	2	152	170.00	196.00
2 • 1	3	153	208.00	240.00
OFF	4	154	275.00	316.00
THREE WAY NO OFF (60°)	1	049	151.00	174.00
1	2	069	211.00	243.00
• 2	3	089	314.00	361.00
3	4	120	391.00	450.00
THREE WAY WITH-OFF (90°)	1	060	143.00	165.00
OFF	2	080	219.00	252.00
3 • 1	3	100	314.00	361.00
2	4	131	390.00	448.00
FOUR WAY NO OFF (90°)	1	050	158.00	182.00
1	2	070	242.00	278.00
4 • 2	3	090	336.00	386.00
3	4	121	464.00	534.00
FOUR WAY WITH OFF (60°)	1	061	181.00	208.00
OFF	2	081	302.00	347.00
• 1	3	101	402.00	462.00
4 • 2	4	132	492.00	566.00

Switching	Pole	Prog. No.	Unit (₹) Price SE	Unit (₹) Price PS
FIVE WAY NO OFF (60°)	1	051	201.00	231.00
1	2	071	355.00	408.00
• 2	3	091	484.00	556.00
5	4			
FIVE WAY WITH OFF (60°)	1	062	211.00	243.00
OFF	2	082	348.00	400.00
5 • 1	3	102	491.00	565.00
4	4			
SIX WAY WITH NO OFF (60°)	1	052	211.00	243.00
6	2	072	403.00	463.00
• 2	3	092	532.00	612.00
5	4			
SIX WAY WITH OFF (45°)	1	063	273.00	314.00
OFF	2	083	478.00	550.00
6 • 2	3	103	639.00	735.00
5	4			
SEVEN WAY WITH NO OFF (45°)	1	053	266.00	306.00
1	2	073	472.00	543.00
• 3	3	093	656.00	754.00
7	4			
SEVEN WAY WITH OFF (45°)	1	064	273.00	314.00
7 OFF	2	084	473.00	544.00
• 1	3	104	631.00	726.00
6	4			
EIGHT WAY WITH NO OFF (45°)	1	054	280.00	323.00
8	2	074	506.00	582.00
• 3	3	094	697.00	802.00
7	4			
EIGHT WAY WITH OFF (30°)	1	065	273.00	314.00
0	2	085	513.00	590.00
• 1	3			
8	4			

Switching	Pole	Prog. No.	Unit (₹) Price SE	Unit (₹) Price PS
ON-OFF (90°)	1	195	106.00	122.00
OFF	2	198	126.00	145.00
ON • ON	3	197	138.00	159.00
OFF	4	196	181.00	208.00
ON-OFF (90°)	1	191	106.00	122.00
OFF	2	192	121.00	145.00
• ON	3	199	138.00	159.00
	4	194	181.00	208.00
NINE WAY WITH NO OFF (30°)	1	055	328.00	377.00
1	2	075	547.00	629.00
• 2	3			
9	4			
NINE WAY WITH OFF (30°)	1	066	328.00	377.00
0	2	086	581.00	668.00
• 1	3			
9	4			
TEN WAY NO OFF (30°)	1	056	547.00	629.00
1	2	076	642.00	739.00
• 2	3			
10	4			
TEN WAY WITH OFF (30°)	1	067	342.00	393.00
0	2	087	587.00	646.00
• 1	3			
10	4			
ELEVEN WAY NO OFF (30°)	1	057	519.00	597.00
11	2	077	683.00	786.00
• 1	3			
10	4			
ELEVEN WAY WITH OFF (30°)	1	068	532.00	612.00
11	2	088	690.00	793.00
• 0	3			
10	4			

Std. Pkg. 20 Nos.

**CAM OPERATED ROTARY SWITCHES 6 Amps.**

Switching	Pole	Prog. No.	Unit (₹) Price SE	Unit (₹) Price PS
TWELVE WAY NO OFF (30°) 	1	058	532.00	612.00
	2	078	743.00	855.00



**VOLTMETER SELECTOR SWITCHES**

Unit Price (₹)

**AMMETER SELECTOR SWITCHES**

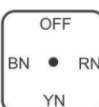
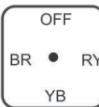
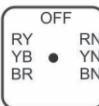
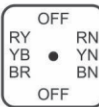

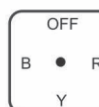
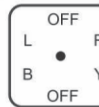
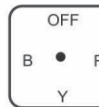
Switching	Pole	Amps	Prog. No.	Description	Unit (₹) Price SE	Unit (₹) Price PS
	3	6	311	Voltage Between Phase to Neutral with off	273.00	314.00
	3	10	311		329.00	378.00
	3	6	312	Voltage Between Phase to Phase with off	145.00	169.00
	3	10	312		211.00	243.00
	3	6	313	Voltage Between Phase to Phase and Phase to Neutral with off	273.00	314.00
	3	10	313		410.00	472.00
	3	6	314	Voltage Between Phase to Phase and Phase to Neutral with off	342.00	394.00
	3	10	314		472.00	543.00



Switching	Pole	Amps	Prog. No.	Description	Unit (₹) Price SE	Unit (₹) Price PS
	3	6	325	To Read Current to be used with CT with Off -do-	201.00	231.00
	3	10	325		273.00	314.00
	3	10	721	Current in Each Phase and Leakage or Out of Balance Current with Off	615.00	703.00
	3	10	710	Direct Reading Ammeter Selector Switches without CT's		792.00
	3	16	710		820.00	943.00
	3	25	710		908.00	1045.00
	3	32	710		956.00	1100.00
	3	40	710		1400.00	1610.00
	3	63	710		1529.00	1758.00

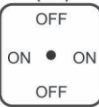
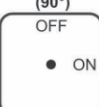
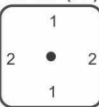

Std. Pkg. 20 Nos.

**CAM OPERATED ROTARY SWITCHES 10 Amps.**

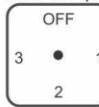
Unit Price (₹)

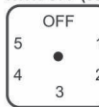
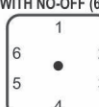
Switching	Pole	Prog. No.	Unit (₹) Price SE	Unit (₹) Price PS
ON-OFF (90°) 	1	195	203.00	233.00
	2	198	231.00	266.00
	3	197	264.00	304.00
	4	196	289.00	333.00
ON-OFF (90°) 	1	191	203.00	233.00
	2	192	231.00	266.00
	3	199	264.00	304.00
	4	194	289.00	333.00
TWO WAY WITH NO-OFF (90°) 	1	037	253.00	291.00
	2	038	297.00	342.00
	3	039	402.00	462.00
	4	040	450.00	517.00
TWO WAY WITH OFF (90°) 	1	151	248.00	285.00
	2	152	293.00	336.00
	3	153	389.00	447.00
	4	154	438.00	503.00

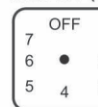
Switching	Pole	Prog. No.	Unit (₹) Price SE	Unit (₹) Price PS
THREE WAY WITH OFF (90°) 	1	060	293.00	336.00
	2	080	358.00	411.00
	3	100	424.00	487.00
	4	131	581.00	668.00
FOUR WAY WITH NO-OFF (90°) 	1	050	328.00	377.00
	2	070	410.00	472.00
	3	090	479.00	550.00
	4	121	669.00	769.00
FIVE WAY WITH OFF (60°) 	1	062	395.00	454.00
	2	082	462.00	531.00
	3	102	663.00	763.00
SIX WAY WITH NO-OFF (60°) 	1	052	382.00	439.00
	2	072	519.00	597.00
	3	092	711.00	818.00

Switching	Pole	Prog. No.	Unit (₹) Price SE	Unit (₹) Price PS
SEVEN WAY WITH OFF (45°) 	1	064	410.00	472.00
	2	084	581.00	668.00
	3	104	845.00	971.00
EIGHT WAY WITH NO-OFF (45°) 	1	054	471.00	541.00
	2	074	607.00	698.00
	3	094	997.00	1146.00

Std. Pkg. 20 Nos.

SE TYPE



PS TYPE

Std. Pkg. 20 Nos.

**CAM OPERATED ROTARY SWITCHES**

**16 Amps.**

**25 Amps.**

**32 Amps.**

**40 Amps.**

Switching	Pole	Prog. No.	Unit (₹) Price SE	Unit (₹) Price PS	Unit (₹) Price SE	Unit (₹) Price PS	Unit (₹) Price SE	Unit (₹) Price PS	Unit (₹) Price SE	Unit (₹) Price PS
ON-OFF (90°) 	1	195	211.00	243.00	237.00	272.00	293.00	336.00	423.00	487.00
	2	198	244.00	281.00	264.00	304.00	317.00	364.00	485.00	558.00
	3	197	297.00	342.00	363.00	417.00	429.00	493.00	566.00	651.00
	4	196	328.00	377.00	450.00	517.00	537.00	617.00	649.00	746.00
ON-OFF (90°) 	1	191	211.00	243.00	237.00	272.00	293.00	336.00	423.00	487.00
	2	192	244.00	281.00	264.00	304.00	317.00	364.00	485.00	558.00
	3	199	297.00	342.00	363.00	417.00	429.00	493.00	566.00	651.00
	4	194	328.00	377.00	450.00	517.00	537.00	617.00	649.00	746.00
TWO WAY WITH NO-OFF(90°) 	1	037	275.00	316.00	297.00	342.00	352.00	405.00	473.00	544.00
	2	038	314.00	360.00	403.00	463.00	484.00	557.00	682.00	784.00
	3	039	414.00	476.00	534.00	614.00	671.00	772.00	810.00	931.00
	4	040	471.00	541.00	627.00	721.00	907.00	1043.00	974.00	1119.00
TWO WAY WITH OFF(90°) 	1	151	270.00	310.00	295.00	340.00	346.00	398.00	464.00	534.00
	2	152	303.00	348.00	396.00	455.00	473.00	544.00	672.00	773.00
	3	153	407.00	468.00	527.00	606.00	666.00	766.00	791.00	909.00
	4	154	456.00	525.00	616.00	708.00	812.00	933.00	963.00	1107.00
THREE WAY WITH OFF(90°) 	1	060	330.00	380.00	409.00	471.00	473.00	844.00	647.00	744.00
	2	080	435.00	500.00	526.00	605.00	588.00	677.00	806.00	927.00
	3	100	567.00	651.00	792.00	911.00	817.00	940.00	1236.00	1422.00
	4	131	710.00	816.00	1024.00	1177.00	1074.00	1235.00	1528.00	1757.00
FOUR WAY WITH NO OFF(90°) 	1	050	348.00	400.00	437.00	502.00	521.00	600.00	710.00	816.00
	2	070	437.00	502.00	493.00	567.00	745.00	856.00	1011.00	1163.00
	3	090	656.00	754.00	779.00	896.00	983.00	1131.00	1565.00	1800.00
	4	121	777.00	894.00	1144.00	1316.00	1232.00	1417.00	1986.00	2284.00
FIVE WAY WITH OFF(60°) 	1	062	430.00	495.00	587.00	675.00	707.00	813.00	819.00	942.00
	2	082	629.00	724.00	835.00	960.00	993.00	1142.00	1434.00	1650.00
	3	102	956.00	1100.00	1080.00	1242.00	1283.00	1475.00	2049.00	2357.00
SIX WAY WITH NO-OFF(60°) 	1	052	450.00	518.00	606.00	697.00	727.00	836.00	1092.00	1256.00
	2	072	660.00	759.00	1038.00	1194.00	1230.00	1414.00	1530.00	1760.00
	3	092	1051.00	1209.00	1173.00	1348.00	1401.00	1612.00	2390.00	2749.00
SEVEN WAY WITH OFF(45°) 	1	064	501.00	576.00	618.00	711.00	745.00	856.00	1162.00	1336.00
	2	084	724.00	832.00	1122.00	1290.00	1336.00	1537.00	1803.00	2073.00
	3	104	947.00	1089.00	1346.00	1548.00	1615.00	1857.00	2800.00	3220.00
EIGHT WAY WITH NO OFF(45°) 	1	054	532.00	612.00	646.00	742.00	776.00	892.00	1366.00	1571.00
	2	074	868.00	998.00	1137.00	1308.00	1364.00	1569.00	2118.00	2435.00
	3	094	1133.00	1303.00	1481.00	1703.00	1769.00	2034.00	3055.00	3513.00



Std. Pkg. 20 Nos.

**CAM OPERATED ROTARY SWITCHES 63 Amps.**

Switching	Pole	Prog. No.	Unit (₹) Price SE	Unit (₹) Price PS
ON-OFF (90°)	1	195	473.00	544.00
OFF	2	198	561.00	645.00
ON ● ON	3	197	712.00	818.00
OFF	4	196	820.00	942.00
ON-OFF (90°)	1	191	473.00	544.00
OFF	2	192	561.00	645.00
● ON	3	199	712.00	818.00
	4	194	820.00	942.00
TWO WAY WITH NO-OFF(90°)	1	037	513.00	590.00
1	2	038	738.00	849.00
2 ● 2	3	039	993.00	1142.00
1	4	040	1253.00	1440.00
TWO WAY WITH OFF(90°)	1	151	608.00	700.00
OFF	2	152	838.00	964.00
2 ● 1	3	153	1090.00	1254.00
OFF	4	154	1252.00	1440.00

Switching	Pole	Prog. No.	Unit (₹) Price SE	Unit (₹) Price PS
THREE WAY WITH OFF(90°)	1	060	706.00	812.00
OFF	2	080	980.00	1127.00
3 ● 1	3	100	1407.00	1618.00
2	4	131	1788.00	2056.00
FOUR WAY WITH NO OFF(90°)	1	050	881.00	1013.00
1	2	070	1094.00	1257.00
4 ● 2	3	090	1663.00	1913.00
3	4	121	2136.00	2457.00
FIVE WAY WITH OFF(60°)	1	062	956.00	1099.00
OFF	2	082	1694.00	1948.00
5 ● 1	3	102	2186.00	2513.00
4 3				
SIX WAY WITH NO-OFF(60°)	1	052	1229.00	1413.00
1	2	072	1844.00	2120.00
6 ● 2	3	092	2732.00	3142.00
5 3				
4				

Switching	Pole	Prog. No.	Unit (₹) Price SE	Unit (₹) Price PS
SEVEN WAY WITH OFF(45°)	1	064	1366.00	1571.00
OFF	2	084	2049.00	2357.00
7 ● 1	3	104	3142.00	3613.00
6 2				
5 4 3				
EIGHT WAY WITH NO OFF(45°)	1	054	1639.00	1885.00
8 1 2	2	074	2459.00	2827.00
7 ● 3	3	094	3416.00	3928.00
6 5 4				

Std. Pkg. 10 Nos.



**CAM OPERATED ROTARY SWITCHES 100 Amps.**

Unit Price (₹)

Switching	Pole	Prog. No.	Unit (₹) Price SE
ON-OFF (90°)	1	195	745.00
OFF	2	198	1064.00
ON ● ON	3	197	1611.00
OFF	4	196	1848.00
ON-OFF (90°)	1	191	745.00
OFF	2	192	1064.00
● ON	3	199	1611.00
	4	194	1848.00
TWO WAY WITH NO-OFF(90°)	1	037	952.00
1	2	038	1624.00
2 ● 2	3	039	2173.00
1	4	040	2666.00
TWO WAY WITH OFF(90°)	1	151	930.00
OFF	2	152	1610.00
2 ● 1	3	153	2164.00
OFF	4	154	2640.00

Switching	Pole	Prog. No.	Unit (₹) Price SE
THREE WAY WITH OFF(90°)	1	060	1584.00
OFF	2	080	2240.00
3 ● 1	3	100	3035.00
2	4	131	3958.00
FOUR WAY WITH NO OFF(90°)	1	050	1827.00
1	2	070	3021.00
4 ● 2	3	090	3958.00
3	4	121	5410.00
FIVE WAY WITH OFF(60°)	1	062	1874.00
OFF	2	082	3300.00
5 ● 1	3	102	5014.00
4 2			
3			
SIX WAY WITH NO-OFF(60°)	1	052	2111.00
1	2	072	3958.00
6 ● 2	3	092	5410.00
5 3			
4			

Switching	Pole	Prog. No.	Unit (₹) Price SE
SEVEN WAY WITH OFF(45°)	1	064	2454.00
OFF	2	084	4487.00
7 ● 1	3	104	6861.00
6 2			
5 4 3			
EIGHT WAY WITH NO OFF(45°)	1	054	2771.00
8 1 2	2	074	5410.00
7 ● 3	3	094	7390.00
6 5 4			

Std. Pkg. 10 Nos.



Std. Pkg. 10 Nos.



**CAM OPERATED ROTARY SWITCHES 150 Amps.**

Unit Price (₹)

Switching	Pole	Prog. No.	Unit (₹) Price SE
ON-OFF (90°)	1	195	842.00
OFF	2	198	1202.00
ON ● ON	3	197	1819.00
OFF	4	196	2087.00
ON-OFF (90°)	1	191	842.00
OFF	2	192	1202.00
● ON	3	199	1819.00
	4	194	2087.00
TWO WAY WITH NO-OFF(90°)	1	037	1075.00
1	2	038	1840.00
2 ● 2	3	039	2454.00
1	4	040	3011.00
TWO WAY WITH OFF(90°)	1	151	1075.00
OFF	2	152	1840.00
2 ● 1	3	153	2454.00
OFF	4	154	3011.00

Switching	Pole	Prog. No.	Unit (₹) Price SE
THREE WAY WITH OFF(90°)	1	060	1788.00
OFF	2	080	2530.00
3 ● 1	3	100	3428.00
2	4	131	4471.00
FOUR WAY WITH NO OFF(90°)	1	050	2063.00
1	2	070	3412.00
4 ● 2	3	090	4470.00
3	4	121	6110.00
FIVE WAY WITH OFF(60°)	1	062	2116.00
OFF	2	082	3726.00
5 ● 1	3	102	5662.00
4 3			
SIX WAY WITH NO-OFF(60°)	1	052	2384.00
1	2	072	4470.00
6 ● 2	3	092	6110.00
5 3			
4			

Switching	Pole	Prog. No.	Unit (₹) Price SE
SEVEN WAY WITH OFF(45°)	1	064	2772.00
OFF	2	084	5067.00
7 1	3	104	7749.00
6 ● 2			
5 4 3			
EIGHT WAY WITH NO OFF(45°)	1	054	3129.00
8 1 2	2	074	6110.00
7 ● 3	3	094	8337.00
6 5 4			

Std. Pkg. 10 Nos.



Std. Pkg. 10 Nos.



**PHASE SELECTOR SWITCHES (1 Pole 3 Way & Prog. No: 060)**

Description : Incoming 3 Phase outgoing single Phase  
Unit Price (₹)

Switching	16 Amps.		25 Amps.		32 Amps.		40 Amps.		63 Amps.		100 Amps.
	Unit Price SE	Unit Price PS	Unit Price SE	Unit Price PS	Unit Price SE	Unit Price PS	Unit Price SE	Unit Price PS	Unit Price SE	Unit Price PS	Unit Price SE
	330.00	380.00	409.00	471.00	473.00	544.00	647.00	744.00	706.00	812.00	1584.00

**Spl. - PHASE SELECTOR SWITCHES**

Description : Incoming 3 Phase outgoing single Phase

Switching	Prog. No.	25 Amps.		32 Amps.		40 Amps.		63 Amps.		100 Amps.
		Unit Price SE	Unit Price PS	Unit Price SE	Unit Price PS	Unit Price SE	Unit Price PS	Unit Price SE	Unit Price PS	Unit Price SE
	060H	458.00	526.00	545.00	629.00	751.00	864.00	820.00	942.00	1640.00

**FORWARD -OFF - REVERSE SWITCHES (AC-3) (3 Pole & Prog. No: 211)**

Unit Price (₹)

Switching	6 Amps.		10 Amps.		16 Amps.		25 Amps.		32 Amps.		40 Amps.		63 Amps.		100 Amps.
	Unit Price SE	Unit Price PS	Unit Price SE	Unit Price PS	Unit Price SE	Unit Price PS	Unit Price SE	Unit Price PS	Unit Price SE	Unit Price PS	Unit Price SE	Unit Price PS	Unit Price SE	Unit Price PS	Unit Price SE
	188.00	216.00	394.00	453.00	407.00	468.00	541.00	622.00	576.00	663.00	1186.00	1364.00	1423.00	1637.00	2400.00

Switching	Pole	Prog. No.	25A SE	25A PS	Switching	Pole	Prog. No.	25A SE	25A PS	32A SE	32A PS	Switching	Pole	Prog. No.	25A SE	25A PS	32A SE	32A PS
	3	212	770.00	885.00		3	217	1031.00	1185.00	1162.00	1336.00		3	217N	1113.00	1280.00	1202.00	1382.00
Two Speed Forward				Two Speed Reverse Forward				Two Speed Reverse Forward with four step OFF										

**ROTARY SWITCHES FOR MOTOR DUTY APPLICATIONS (Without Metal Box)**

**(3 Pole & Prog. No. 244)** Unit Price (₹)

Switching	10 Amps.		16 Amps.		25 Amps.		32 Amps.		40 Amps.		63 Amps.	
	Unit Price SE	Unit Price PS	Unit Price SE	Unit Price PS	Unit Price SE	Unit Price PS	Unit Price SE	Unit Price PS	Unit Price SE	Unit Price PS	Unit Price SE	Unit Price PS
	250.00	288.00	286.00	330.00	349.00	401.00	397.00	457.00	497.00	572.00	683.00	785.00

**STAR DELTA SWITCH (3 Pole & Prog. No: 200)** Unit Price (₹)

Switching	16 Amps.		25 Amps.		32 Amps.		40 Amps.		63 Amps.	
	Unit Price SE	Unit Price PS	Unit Price SE	Unit Price PS	Unit Price SE	Unit Price PS	Unit Price SE	Unit Price PS	Unit Price SE	Unit Price PS
	460.00	528.00	560.00	644.00	635.00	730.00	1229.00	1413.00	1366.00	1571.00

**PHASE SELECTOR SWITCHES IN SHEET STEEL ENCLOSURE WITH 3 ROTARY SWITCHES & 3 INDICATORS (R,Y,B)** Unit Price (₹)

**(3 Pole & Prog. No: 3060DB)**

Description : Incoming 3 Phase outgoing single Phase

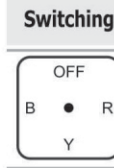

25 Amps.		32 Amps.		40 Amps.		63 Amps.		100 Amps.
Unit Price SE	Unit Price PS	Unit Price SE	Unit Price PS	Unit Price SE	Unit Price PS	Unit Price SE	Unit Price PS	Unit Price SE
2358.00	2544.00	2550.00	2763.00	4377.00	4668.00	4554.00	4872.00	7188.00

**PHASE SELECTOR SWITCHES IN SHEET STEEL ENCLOSURE WITH 1 ROTARY SWITCH & 3 INDICATORS (R,Y,B)**

**Prog. No: 1060DB**

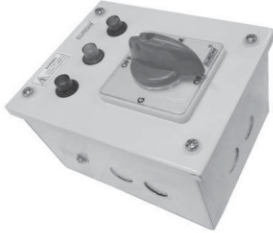

25 Amps.		32 Amps.		40 Amps.		63 Amps.		100 Amps.
Unit Price SE	Unit Price PS	Unit Price SE	Unit Price PS	Unit Price SE	Unit Price PS	Unit Price SE	Unit Price PS	Unit Price SE
1689.00	1751.00	1753.00	1824.00	1961.00	2058.00	2020.00	2126.00	2898.00

**REVERSE FORWARD SWITCHES IN SHEET STEEL ENCLOSURE WITH 1 ROTARY SWITCH**

Switching	Pole	Prog.	10 A. - SE	10 A. - PS	16 A. - SE	16 A. - PS	25 A. - SE	25 A. - PS	32 A. - SE	32 A. - PS
OFF FOR. REV.	3	913	561.00	620.00	574.00	635.00	708.00	789.00	743.00	833.00



**REVERSE FORWARD SWITCHES IN SHEET STEEL ENCLOSURE WITH 1 ROTARY SWITCH & 3 INDICATORS (R,Y,B) WITH BALL HANDLE**

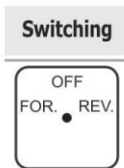

Pole	Prog.	40 Amps.		63 Amps.		100 Amps.	150 Amps.
		Unit Price SE	Unit Price PS	Unit Price SE	Unit Price PS	Unit Price SE	Unit Price SE
3	913	2500.00	2678.00	2737.00	2951.00	3714.00	3050.00



**MULTI SOCKET SHEET STEEL ENCLOSURE - Only Empty Enclosure**

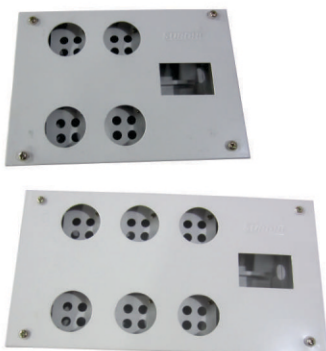

Description	Code	Unit Price
2 Sockets Box with four pole MCB space suitable for 20/2 sockets.	SDV-DPSB M2	575.00
4 Sockets Box with four pole MCB space suitable for 20/2 sockets.	SDV-DPSB M4	885.00
4 Sockets Box without MCB space suitable for 20/2 sockets.	SDV-DPSB 4	689.00
6 Sockets Box with four pole MCB space suitable for 20/2 sockets.	SDV-DPSB M6	1000.00
6 Sockets Box without MCB space suitable for 20/2 sockets.	SDV-DPSB 6	877.00
4 Sockets Box with eight pole MCB space suitable for 20/3 sockets.	SDV-TPSB M8	1139.00
2 Sockets Box with four pole MCB space suitable for 30/3 sockets.	SDV-TPSB M-4	873.00

**PHASE SELECTOR SWITCHES IN SHEET STEEL ENCLOSURE WITH 3 ROTARY SWITCHES & 3 INDICATORS (R,Y,B)** Unit Price (₹)

**(3 Pole & Prog. No: 3060DB)**

Description : Incoming 3 Phase outgoing single Phase

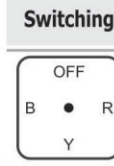

25 Amps.		32 Amps.		40 Amps.		63 Amps.		100 Amps.
Unit Price SE	Unit Price PS	Unit Price SE	Unit Price PS	Unit Price SE	Unit Price PS	Unit Price SE	Unit Price PS	Unit Price SE
2358.00	2544.00	2550.00	2763.00	4377.00	4668.00	4554.00	4872.00	7188.00

**PHASE SELECTOR SWITCHES IN SHEET STEEL ENCLOSURE WITH 1 ROTARY SWITCH & 3 INDICATORS (R,Y,B)**

**Prog. No: 1060DB**

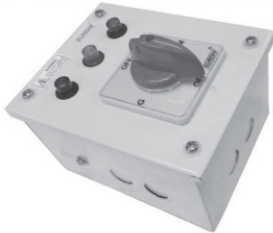

25 Amps.		32 Amps.		40 Amps.		63 Amps.		100 Amps.
Unit Price SE	Unit Price PS	Unit Price SE	Unit Price PS	Unit Price SE	Unit Price PS	Unit Price SE	Unit Price PS	Unit Price SE
1689.00	1751.00	1753.00	1824.00	1961.00	2058.00	2020.00	2126.00	2898.00

**REVERSE FORWARD SWITCHES IN SHEET STEEL ENCLOSURE WITH 1 ROTARY SWITCH**

Switching	Pole	Prog.	10 A. - SE	10 A. - PS	16 A. - SE	16 A. - PS	25 A. - SE	25 A. - PS	32 A. - SE	32 A. - PS
OFF FOR. REV.	3	913	561.00	620.00	574.00	635.00	708.00	789.00	743.00	833.00



**REVERSE FORWARD SWITCHES IN SHEET STEEL ENCLOSURE WITH 1 ROTARY SWITCH & 3 INDICATORS (R,Y,B) WITH BALL HANDLE**

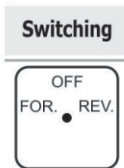

Pole	Prog.	40 Amps.		63 Amps.		100 Amps.	150 Amps.
		Unit Price SE	Unit Price PS	Unit Price SE	Unit Price PS	Unit Price SE	Unit Price SE
3	913	2500.00	2678.00	2737.00	2951.00	3714.00	3050.00



**MULTI SOCKET SHEET STEEL ENCLOSURE - Only Empty Enclosure**

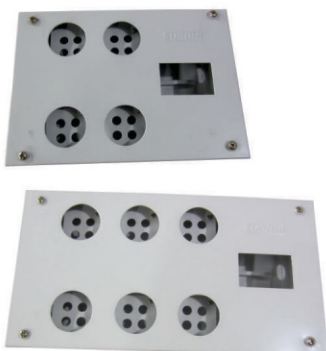

Description	Code	Unit Price
2 Sockets Box with four pole MCB space suitable for 20/2 sockets.	SDV-DPSB M2	575.00
4 Sockets Box with four pole MCB space suitable for 20/2 sockets.	SDV-DPSB M4	885.00
4 Sockets Box without MCB space suitable for 20/2 sockets.	SDV-DPSB 4	689.00
6 Sockets Box with four pole MCB space suitable for 20/2 sockets.	SDV-DPSB M6	1000.00
6 Sockets Box without MCB space suitable for 20/2 sockets.	SDV-DPSB 6	877.00
4 Sockets Box with eight pole MCB space suitable for 20/3 sockets.	SDV-TPSB M8	1139.00
2 Sockets Box with four pole MCB space suitable for 30/3 sockets.	SDV-TPSB M-4	873.00

## CHANGEOVER SWITCHES (90° DOUBLE THROW)

Unit Price (₹)

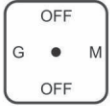
Switching	Pole	Prog. No.	25 Amps.		32 Amps.		40 Amps.		63 Amps.		100 Amps.
			Unit Price SE	Unit Price PS	Unit Price SE	Unit Price PS	Unit Price SE	Unit Price PS	Unit Price SE	Unit Price PS	Unit Price SE
	2	152CO	396.00	455.00	473.00	544.00	672.00	773.00	838.00	964.00	1582.00
	3	153CO	527.00	606.00	666.00	767.00	791.00	909.00	1090.00	1254.00	2125.00
	4	154CO	626.00	720.00	901.00	1036.00	963.00	1107.00	1252.00	1440.00	2593.00

### THREE POLE ON-OFF WITH METAL BOX

Pole	Prog. No.	25 Amps.	
		Unit Price SE	Unit Price PS
3	244	528.00	607.00

### SPRING RETURN BREAKER CONTROL SWITCHES (Trip-Neutral-Close) with Pistol Grip Handle 25Amps.

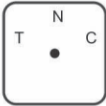

Unit Price (₹)

Switching	Pole	Prog. No.	Description	Unit Price SE	Unit Price PS
	2	257	TNC with 1NO+1NC Spring Return	605.00	696.00
	4	009	TNC with 2NO+2NC Spring Return	759.00	873.00

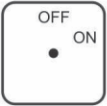
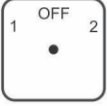
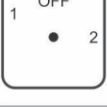
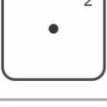
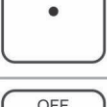

### SPRING RETURN SWITCHES WITHOUT HANDLE

Unit Price (₹)

Switching	Pole	Prog. No.	Description	6 Amp. 45°		16 Amp. 60°		25 Amps. 60°		32 Amps. 60°	
				Unit Price SE	Unit Price PS	Unit Price SE	Unit Price PS	Unit Price SE	Unit Price PS	Unit Price SE	Unit Price PS
	1	351	On-off with Spring Return to Off	108.00	124.00	330.00	369.00	430.00	495.00	467.00	538.00
	2	352		130.00	149.00	405.00	466.00	763.00	878.00	822.00	945.00
	3	353		143.00	164.00	506.00	581.00	887.00	1020.00	983.00	1131.00
	4	354		194.00	223.00	539.00	620.00	959.00	1103.00	1082.00	1245.00
	1	361	Double Throw Spring Return Both Side to off	136.00	157.00	447.00	514.00	487.00	560.00	528.00	607.00
	2	362		187.00	215.00	531.00	611.00	610.00	702.00	664.00	764.00
	3	363		244.00	281.00	678.00	779.00	796.00	915.00	860.00	989.00
	1	364	Three Position with one Position Spring Return to off	136.00	157.00	----	----	----	----	----	----
	2	365		187.00	215.00	----	----	----	----	----	----
	3	369		244.00	281.00	----	----	----	----	----	----
	1	371	Two Position Spring Return Switches 2 to 1	136.00	157.00	447.00	514.00	487.00	560.00	528.00	607.00
	2	372		187.00	215.00	531.00	611.00	610.00	702.00	664.00	764.00
	3	373		244.00	281.00	678.00	779.00	796.00	915.00	860.00	989.00
	1	300	Stop-Start Switch	172.00	197.00	388.00	446.00	454.00	522.00	528.00	607.00
	2	388	Spring Return to Centre Position	231.00	265.00	531.00	611.00	616.00	708.00	663.00	763.00
	3	211 S	Forward-off-Reverse Spring Return to off	216.00	248.00	557.00	641.00	612.00	705.00	650.00	747.00

NOTE :-  
MOUNTING SIZE OF 16Amp. 25Amp. 32Amp. Spring Return Rotary Switches are Same.

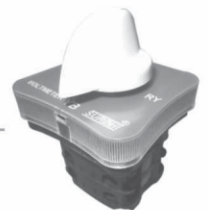

## SPARES FOR ROTARY SWITCHES

Unit Price (₹)

### SCRIPT PLATES (MARKETING PLATES) (PS)

Description	Size In mm. L x B	Unit Price
6, 10 & 16 AMPS.	47 x 47	9.00
25 To 32 AMPS.	61 x 61	17.00
40 To 63 AMPS.	84 x 84	21.00

### SCRIPT PLATES (MARKING PLATES) (SE)

Description	Size In mm. L x B	Unit Price
6, 10 & 16 AMPS.	45 x 45	6.60
25 & 32 AMPS.	61 x 61	14.50
40 To 63 AMPS.	84 x 84	17.00



Colours Available  
Yellow, Grey & White

### KNOBS

Description	Size In mm. L x B x H	Unit Price SE	Unit Price PS
Tear Drop for 6, 10 & 16 AMPS.	41 X 28 X 19	28.00	28.00
Tear Drop for 25 & 32 AMPS.	52 X 36 X 25	34.00	34.00
Tear Drop for 40 & 63 AMPS.	72 X 51 X 31	51.00	51.00



Colours Available - Red, Blue,  
Black & White

### Pistol Grip Handle for TNC



₹ 108.00

### BALL HANDLES (SE)

Description	Size In mm. L x B	Unit Price	Unit Price PS
Ball Handle for 6A to 100A	64 x 64 x 64 x 80	55.00	55.00



### REAR PANEL PLATE (SE)

Description	Size In mm. L x B	Unit Price	Unit Price PS
6, 10 & 16 AMPS.	48 x 48	10.00	10.00
25 & 32 AMPS.	60 x 60	11.50	11.50
40 to 63 AMPS.	83 x 83	26.50	26.50

## ACCESSORIES FOR ONLOAD CHANGEOVER SWITCH

HANDLE



MOUNTING  
EXTENSION

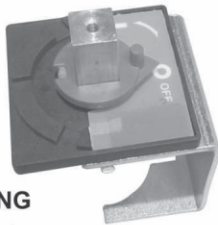

ASSEMBLY  
SPINDLE

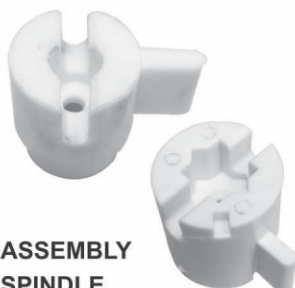

CAT. NO.	Description	HSN CODE 85381010	Size	Unit Price
SDV-00 H	SUITABLE FOR OLC, BY PASS & LOAD BREAK 63, 80 & 100A		00	154.00
SDV-01 H	SUITABLE FOR OLC, BY PASS & LOAD BREAK 100A TO 200A		01	340.00
SDV-02 H	SUITABLE FOR OLC, BY PASS & LOAD BREAK 250A TO 320A		02	340.00
SDV-03 H	SUITABLE FOR OLC, BY PASS & LOAD BREAK 400A TO 630A		03	340.00

CAT. NO.	Description	HSN CODE 85381010	Size	Unit Price
SDV-00 M	SUITABLE FOR OLC, BY PASS & LOAD BREAK 63, 80 & 100A		00	220.00
SDV-01 - M	SUITABLE FOR OLC, BY PASS & LOAD BREAK 100A TO 200A		01	473.00
SDV-02 - M	SUITABLE FOR OLC, BY PASS & LOAD BREAK 250A TO 320A		02	473.00
SDV-03 - M	SUITABLE FOR OLC, BY PASS & LOAD BREAK 400A TO 630A		03	473.00

CAT. NO.	Description	HSN CODE 85381010	Size	Unit Price
SDV- 00 S	SUITABLE FOR OLC, BY PASS & LOAD BREAK 63, 80 & 100A		00	44.00
SDV- 01 S	SUITABLE FOR OLC, BY PASS & LOAD BREAK 100A TO 200A		01	110.00
SDV-02 S	SUITABLE FOR OLC, BY PASS & LOAD BREAK 250A TO 320A		02	110.00
SDV 03 S	SUITABLE FOR OLC, BY PASS & LOAD BREAK 400A TO 630A		03	110.00

## CUBICLE ONLOAD CHANGEOVER SWITCHES

4 Pole 63 Amp. to 630 Amp. 415 V, 50Hz Unit Price (₹)

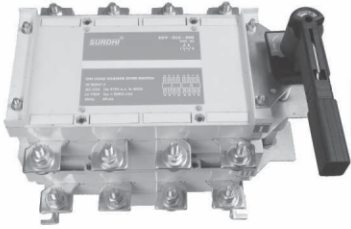

Frame Size	Amp.	Open Execution Cat No.	With Sheet Steel Enclosures Cat No.	Open Execution Unit Price (₹)	With Sheet Steel Enclosures Unit Price (₹)	Std. packing
00	63	SDV-OLC 63	SDV-OLC 63 EN	3410.00	5049.00	12 Pcs.
00	80	SDV-OLC 80	SDV-OLC 80 EN	4277.00	6261.00	
00	100	SDV-OLC 100	SDV-OLC 100 EN	4510.00	6500.00	
01	100	SDV-OLC 100	SDV-OLC 100 EN	6415.00	9385.00	4 Pcs.
01	125	SDV-OLC 125	SDV-OLC 125 EN	6685.00	9655.00	
01	160	SDV-OLC 160	SDV-OLC 160 EN	7579.00	10549.00	
01	200	SDV-OLC 200	SDV-OLC 200 EN	8435.00	11405.00	
02	250	SDV-OLC 250	SDV-OLC 250 EN	12949.00	17888.00	2 Pcs.
02	320	SDV-OLC 320	SDV-OLC 320 EN	13145.00	18095.00	
03	400	SDV-OLC 400	SDV-OLC 400 EN	18295.00	24821.00	2 Pcs.
03	630	SDV-OLC 630	SDV-OLC 630 EN	21740.00	28600.00	

## CUBICLE FUSE CHANGEOVER SWITCHES

Confirm to IEC 947 - 3 front operated 4 Pole 415 V 50 Hz suitable for bolted type HBC fuse links

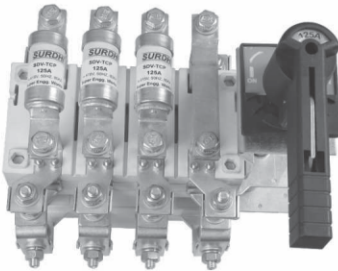

Frame Size	Amp.	Open Execution Cat No.	Open Execution Unit Price (₹)
01	100	SDV-OLCF 100	8470.00
01	125	SDV-OLCF 125	8800.00
01	160	SDV-OLCF 160	9240.00
01	200	SDV-OLCF 200	9460.00

### EMPTY ENCLOSURE FOR ON LOAD CHANGE OVER SWITCHES

00	63/100Amp.	SDV-EN-MT-00	2046.00
01	100/125/160/200Amp.	SDV-EN-MT -01	3025.00
02	250/320Amp.	SDV-EN-MT-02	5060.00
03	400/630Amp.	SDV-EN-MT-03	6600.00

Std. Packing : 1 Nos.

## LOAD BREAK SWITCH

4 Pole 63 Amp. to 630 Amp. 415 V, 50Hz

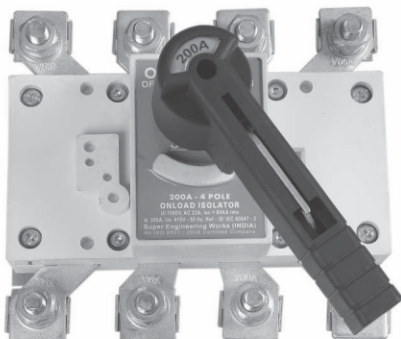

Frame Size	Amp.	Open Execution Cat No.	Open Execution Unit Price (₹)
01	100	SDV-LBS-100	3920.00
01	125	SDV-LBS-125	4158.00
01	160	SDV-LBS-160	4396.00
01	200	SDV-LBS-200	4769.00
02	250	SDV-LBS-250	7128.00
02	320	SDV-LBS-320	7841.00
03	400	SDV-LBS-400	11286.00
03	630	SDV-LBS-630	11880.00

**BY PASS SWITCHES**

4 Pole 100 Amp. to 630 Amp. 415V, 50Hz

Unit Price (₹)

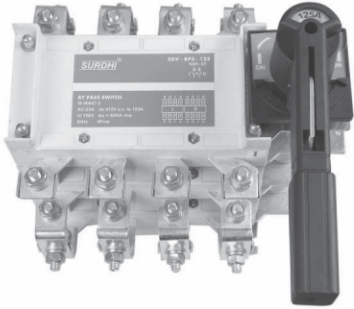

Frame Size	Amp.	Open Execution Cat No.	Open Execution Unit Price (₹)
01	100	SDV-BPS 100	9385.00
01	125	SDV-BPS 125	9504.00
01	160	SDV-BPS 160	9860.00
01	200	SDV-BPS 200	10098.00
02	250	SDV-BPS 250	18576.00
02	320	SDV-BPS 320	18889.00
03	400	SDV-BPS 400	31007.00
03	630	SDV-BPS 630	34452.00

Std. Packing : 1 Nos.

**SWITCH FUSE UNIT (SFU) WITH FUSE**

3 Pole & Neutral 100 Amp. to 200 Amp. 415V, 50Hz

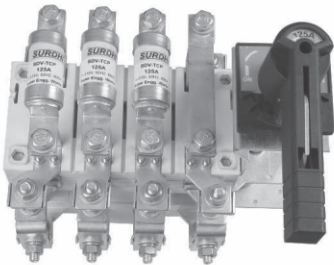

Frame Size	Amp.	Open Execution Cat No.	Open Execution Unit Price (₹)	With Sheet Steel Enclosures Cat No.	With Sheet Steel Enclosures Unit Price (₹)
01	100	SDV-SFU 100	7590.00	SDV-SFU 100 EN	10340.00
01	125	SDV-SFU 125	7700.00	SDV-SFU 125 EN	10450.00
01	160	SDV-SFU 160	7920.00	SDV-SFU 160 EN	10670.00
01	200	SDV-SFU 200	3140.00	SDV-SFU 200 EN	10890.00

Std. Packing : 1 Nos.

**SURDHI DIN Rail Mounted Terminal Block (Polyamide)**

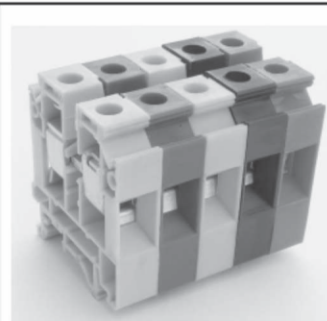

Description - Colour - Grey	Cat. No.	Unit Price	Description - COLOURED	Cat. No.	Unit Price
Terminal Block 2.5 sq. mm	SDV-PTB 2.5	12.65	Terminal Block 2.5 sq. mm	SDV-PTB 2.5C	15.65
Terminal Block 4.0 sq. mm	SDV-PTB 4.5	15.10	Terminal Block 4.0 sq. mm	SDV-PTB 4.0C	18.20
Terminal Block 6.0 sq. mm	SDV-PTB 6.0	18.42	Terminal Block 6.0 sq. mm	SDV-PTB 6.0C	21.60
Terminal Block 10.0 sq. mm	SDV-PTB 10.0	18.80	Terminal Block 10.0 sq. mm	SDV-PTB 10.0C	22.10
Terminal Block 16.0 sq. mm	SDV-PTB 16.0	24.00	Terminal Block 16.0 sq. mm	SDV-PTB 16.0C	28.00
Terminal Block 25.0 sq. mm	SDV-PTB 25.0	29.00	Terminal Block 25.0 sq. mm	SDV-PTB 25.0C	33.50
Terminal Block 35.0 sq. mm	SDV-PTB 35.0	49.00	Terminal Block 35.0 sq. mm	SDV-PTB 35.0C	54.00

Std. Packing: 100 Nos. 35.0 sp.mm 20 Nos.

Available Colour : R, Y, B, BL  
Std. Packing: 100 Nos. 35.0 sq. mm 20 Nos.

**END PLATE FOR SURDHI DIN RAIL MOUNTED TERMINAL BLOCK (POLYAMIDE)**

HSN CODE 85381010	Description	Colour	Std. Packing	Cat. No.	Unit Price
	End Plate 2.5 Sq. mm	GREY	200	SDV-PCTB-NS	3.80
	End Plate 2.5 Sq. mm (coloured)	RD, YW, BL, BK	200	SDV-PCTB-NSC	3.75
	End Plate 4-10 Sq. mm	GREY	100	SDV-PCTB-X	4.00
	End Plate 4-10 Sq. mm (coloured)	RD, YW, BL, BK	100	SDV-PCTB-XC	4.30
	End Plate 16 Sq. mm	GREY	100	SDV-PCTB-Y	6.30
	End Plate 16 Sq. mm (coloured)	RD, YW, BL, BK	100	SDV-PCTB-YC	6.60
	End Plate 25 Sq. mm	GREY	100	SDV-PCTB-Z	6.90
	End Plate 25 Sq. mm (coloured)	RD, YW, BL, BK	100	SDV-PCTB-ZC	7.50
	End Bracket (Heavy) - Stopper	GREY	100	SDV-EBP	10.50
	End Bracket (New) - Stopper	GREY	100	SDV-EBPN	7.70

RD = RED | YW = YELLOW | BL = BLUE | BK = BLACK



## OIL TIGHT LIMIT SWITCHES TYPE SDVL WITH 1 NO + 1 NC CONTACTS

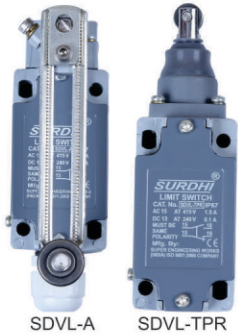

Description	Code	Unit Price
Roller Lever 38 mm long with 19 mm Dia. 8 mm wide Metal roller - Metal Head	SDVL-1	1000.00
Roller Lever 38 mm long with 19 mm Dia. 8 mm wide Metal roller with Plastic Head	SDVLN-1	1000.00
Roller Lever 76.2 mm long with. 19 mm Dia. 8 mm wide Metal Roller - Metal Head	SDVL-2	1000.00
Roller Lever 76.2 mm long with. 19 mm Dia. 8 mm wide Metal Roller with Plastic Head	SDVLN-2	1000.00
Adjustable Roller Lever from 32 mm to 82.5 mm with 19 mm Dia. 8 mm wide Metal Roller - Metal Head	SDVL-A	1000.00
Adjustable Roller Lever from 32 mm to 82.5 mm with 19 mm Dia. 8 mm wide Metal Roller with Plastic Head	SDVLN-A	1000.00
Top Puch Roller Operated with 11.1 mm Dia. 4 mm wide Metal Roller	SDVL-TPR	1000.00
Side Push Roller Operated with 11.1 mm Dia. 4mm wide Metal Roller	SDVL-SPR	1060.00
Side Push Bolt Operated adjustable	SDVL-SPBA	1060.00
Top Spring Operated	SDVL-SSTS	1120.00
General Purpose angular Roller Limit Switch	SDVL-GS	700.00
Roller Lever 38 mm long with 19 mm Dia. 15 mm wide Metal roller.	SDVLX-1	1030.00
Roller Lever 76.2 mm long with. 19 mm Dia. 15 mm wide Metal Roller	SDVLX-2	1030.00
Adjustable Roller Lever from 32 mm to 82.5 mm with 19 mm Dia. 15 mm wide Metal Roller	SDVLX-A	1030.00

SDVLX-A

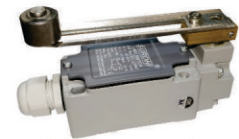

## SPARES FOR THE SDVL LIMIT SWITCHES

Description	Code	Unit Price
38 mm long lever	SDVL-LE	
76.2 MM LONG LEVER		
Adjustable Lever		
<b>BASIC ELEMENT</b>		
Basic Switch Element		
	SDVL-S1	176.00
	SDVL-S2	187.00
	SDVL-SLA	187.00
	SDVL-LE	315.00

SDVL-LE



SDVL-S1



SDVL-S2



SDVLM-A

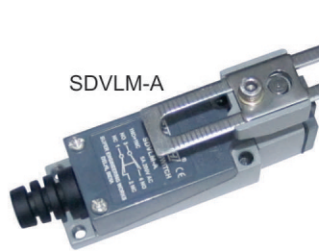

SDVLM-1



SDVLM-TPR



## SURDHI MINI LIMIT SWITCH TYPE SDVLM WITH 1 NO + 1 NC CONTACTS

Description	Code	Unit Price
General Purpose angular Roller	SDVLM-GS	470.00
30 MM Long Lever with 18 mm Dia Nylon Roller	SDVLM-1	515.00
Adjustable Roller Lever from 25 mm to 80 mm with 18 mm Dia Nylon Roller	SDVLM-A	515.00
Top Push Roller Operator with 12.5 mm Nylon Roller	SDVLM-TPR	515.00
Top Spring Operated	SDVLM-SSTS	515.00

## SPARES FOR THE SDVLM LIMIT SWITCHES

Description	Code	Unit Price
30 mm Long Lever		
Adjustable Lever		
<b>BASIC ELEMENT</b>		
	SDVLM-S1	143.00
	SDVLM-SA	154.00
	SDVLM-LE	286.00



SDVLM-LE

## TERMS AND CONDITIONS

- Prices are Ex-works.
- Prices prevailing at the time of dispatch shall be applicable.
- Prices are exclusive of GST, Local taxes which as levied, shall be charged extra at actual.
- Goods are dispatched by us on purchaser's risk.
- All claims for losses, damages or shortages will be filed by the purchaser directly with the carriers.
- All disputes are subject to Delhi Jurisdiction.
- This price list supersedes all our previous price lists, and are subject to change without prior notice.
- Company reserves the right to issue amendments, which may arise due to any errors in price list.

***SURDHI***® *Products are tested at :*  
*Innovation Throughout...*

- **Electrical Research and Development Association (Vadodara)**
- **Electronics Regional Test Laboratory (North) New Delhi**

### **Our Products have been approved and used by :**

1. **Central Public Works Department, New Delhi**
2. **The National Small Industries Corporation Limited, New Delhi**
3. **Northern Railway**
4. **Rail Coach Factory, Kapurthala**
5. **Research Designs & Standards Organisation, Lucknow**
6. **Reliance Industries Limited**
7. **Power Grid Corporation Limited**
8. **ONGC**
9. **Nagarjuna Construction Company Ltd.**
10. **Indraprastha Power Generation Company Ltd.**
11. **HMT**
12. **PSL Limited**
13. **CEEAMA**

Authorised dealers

Mfd. by  
**Super Engineering Works**  
(AN ISO 9001:2015 CERTIFIED COMPANY)  
**(INDIA)**

